



2024

MEET OUR NEW PRODUCTS

UTILITY REFUSE
AND RECYCLING



MOTORIZED SOLUTIONS PAGES 127, 129, 152-154, 172

The Motorized products are ideal for users who want the benefits of using cordless motorized power for moving heavy loads and reducing user strain. The centralized control system features variable speed with forward and reverse settings. The rechargeable battery can be easily changed out to reduce any unnecessary downtime. Dual onboard battery compartments provide back-up power without having to plug in the entire unit, minimizing costly workflow disruptions due to battery switch outs.

DECORATIVE REFUSE

CLEANING

RESIST® CONTAINERS PAGE 59

The durable Resist container is built to withstand tough environments with durability features including dent, graffiti, stain, and UV resistance.



MATERIAL HANDLING



BRUTE MATERIAL HANDLING SOLUTIONS

PAGES 163, 164, 165

BRUTE Rotomolded Tilt Trucks and Heavy Duty Ergonomic Utility Carts are durable, reliable products that transport heavy loads for a variety of demanding work activities.

WASHROOM

TOWABLE SOLUTIONS PAGE 173

Transport multiple heavy oversized loads throughout a facility with up to a 2,500 lb. capacity. The Towable Pallet Cart and Platform Truck allow users to tow up to 3 carts at once with a towing vehicle, using the included heavy-duty tow bar and hitch.



FOODSERVICE



ENHANCE™ CONTAINERS PAGE 47

Enhance is a premium waste system that is purpose built for high-end aesthetics. Combining form and function, Enhance containers are designed for the finest environments.

ACCESSORIES
& INDEX

When ordering products with **BOLD** color codes, please specify color code after the product number. Refer to the Standard Color Guide at the back of the catalog.

UTILITY REFUSE AND RECYCLING

BRUTE® Utility and Recycling 12
 Rollout Containers 17
 Slim Jim® Containers & Accessories..... 20
 Indoor Utility Containers 31
 Recycling 37
 Steel Wastebaskets 38
 Accessories 39

DECORATIVE REFUSE

Indoor Containers 42
 Outdoor Containers 58
 Smoking Management 68

CLEANING

HYGEN™ Microfiber 74
 Microfiber 86
 WaveBrake® Mopping Systems 93
 Wet Mop Selection Guide 96
 Premium Wet Mops 100
 MAXIMIZER™ Wet Mops 102
 Standard Wet Mops 103
 Economy Wet Mops 107
 Specialty and Finish Wet Mops 109
 Wet Mop Handles 110
 Mopping Accessories 111
 Dust Mops 114
 Carpet Bonnets 117
 Brooms 119
 Brushes & Cleaning Brushes 122
 Cleaning Tools 125
 Housekeeping Carts 128
 Quick Carts 132
 Cleaning Carts 134
 Mechanical Sweepers 139
 Tools and Accessories 140

SAFETY

Safety Signs 144
 Safety Cones 146
 Barriers & Absorbents 147

MATERIAL HANDLING

Bulk Collection 154
 Utility Carts 162
 Platform Trucks 170
 Order Picking Solutions 177
 Caster Selection Guide 178
 Cart Accessories 179
 Outdoor Handling and Storage 181

WASHROOM

Skin Care 186
 Sanitizer Stands 195
 Air Care (Active) 198
 Air Care (Passive) 202
 Fixtures 204
 Surface Care 208
 Accessories 210

FOODSERVICE

Storage 214
 Preparation 222
 Monitoring 224
 Transport 225
 Table Service 227
 Youth Service 228

COMMON CONVERSIONS

Common Metric-English Conversions 230

STANDARD COLOR GUIDE

Standard Color Guide 231

INDEX

Product Index 232
 Component Parts 241

CUSTOMER SERVICE 800-347-9800
WWW.RUBBERMAIDCOMMERCIAL.COM

©2024 Rubbermaid Commercial Products LLC
 8900 Northpointe Executive Park Drive
 Huntersville, NC 28078



CERTIFICATIONS

**BS EN ISO 9001/Cleveland, TN**

2000 Overhead Bridge Road
Cleveland, Tennessee 37312, USA
Certificate Number FM 33122

Rubbermaid Commercial Products LLC
operates a quality management system which
complies with the requirements listed above.

ISTA

International Safe Transit Association. The Compacted
Mops were tested and certified via ISTA Test Procedures.

UL

Underwriters Laboratory. The UL Classified baskets
(FG254000, FG254100, FG254200, FG254300,
FG254400) meet the criteria for UL Standard 242 which
is a standard of performance for open top, non-metallic
wastepaper containers. UL classified baskets are generally
found in use in patient care rooms (hospitals/nursing
homes).

Decorative Waste products that are UL Classified have
been tested and approved only to burning paper
containment and resistance to temperature rise of
surrounding surfaces.

Decorative Waste products that are UL Listed/FM
Approved/Fire-Safe/Self-Extinguishing have been tested
and approved for the fire-safe containment of dry
flammable paper waste products.

**FDA**

Food and Drug Administration does not approve
products. The FDA sets regulations which require
compliance.

**NSF Registration Guidelines for Proprietary
Substances and Nonfood Compounds:**

**Handwashing and sanitizing products (Category
Code E2):** Combination of detergents-germicides (single
step preparations designed to combine hand washing
and sanitizing) will be considered for registration on the
basis of their ability to effectively clean the hands as
well as their germicidal equivalency to 50 ppm available
chlorine. The hands need not be washed with soap or
detergent prior to the use of such preparations. However,
the hands must be rinsed with potable water after the
use of the product and before handling food.

Hand sanitizing products (Category Code E3):
Products manufactured from those solutions described
in CFR Title 21, Section 178.1010, which are applicable
for the purpose may be used to sanitize the hands of
employees handling food products without a subsequent
rinse provided they are germicidally equivalent to
50 ppm available chlorine. Products shall not contain
perfumes leaving a residual odor on hands after usage.
These sanitizing solutions may be used only after
thoroughly washing hands with soap or detergent and
water, followed by rinsing with potable water. In many
instances, these hand sanitizers may be injected directly
into wash/rinse water.

ASTM

ASTM 404-18 is an American Society for Testing and
Materials safety standard for evaluating a High Chair.
A "test dummy" that simulates a child of predetermined
size is strapped into the chair and various push, pull,
and racking tests are conducted on the chair and also
using the dummy to simulate forces required to remove
dummy, and to determine the safety aspects of ensuring
proper confinement within the chair without causing
harm to the child.

ASTM 2285-04 is an American Society for Testing
and Materials safety performance specification that
establishes performance requirements, test methods, and
labeling requirements to minimize the hazards to children
presented by Diaper Changing Tables for commercial use
with children up to 50 lbs.

**ADA**

- The Americans with Disabilities Act prohibits
discrimination and ensures equal opportunity for
persons with disabilities in employment, state and
local government services, public accommodations,
commercial facilities, and transportation
- Rubbermaid Commercial Products refuse containers
need to comply with the ADA regulation; as long as
"access openings" for containers are below 48",
containers are compliant to ADA regulations
- All Decorative Waste products comply with ADA Reach
Range Requirements, except for step can models; all
Decorative Waste wall mount models comply with
ADA Reach Range Requirements, dependent upon
height placement within the mandated "Reach Range"



ADA COMPLIANT

CE

The CE marking (an acronym for the French "Conformite
Europeenne") certifies that a product has met EU health,
safety, and environmental requirements, which ensure
consumer safety. Manufacturers in the European Union
(EU) and abroad must meet CE marking requirements
where applicable in order to market their products in
Europe.

**CSFM**

California State Fire Marshal listing is obtained for
various types of containers once tested (by independent
testing laboratories) against specific criteria. Following
our receipt of UL and/or FM approval for those items,
the results were submitted/accepted by California. The
State of California is generally regarded to have the most
stringent fire codes of all the United States. For an annual
fee (every June 30th) the CSFM listings are updated.

Decorative Waste products that are UL Listed/FM
Approved Fire-Safe/Self-Extinguishing and UL Classified
are listed by the California State Fire Marshal pursuant to
section 13144.1 of the California Health and Safety Code.
See CSFM Listing No. 4480-1025:100.

CSFM**FM**

Factory Mutual is an independent testing agency whose
approvals are based on Standard 6921 Combustible
Waste Containers. Standard 6921 is performance
criteria for containers with covers (lids) and their ability
to withstand internal fires, maintain a certain range
of stability, if dumped, and stay intact over a wide
temperature range. Standard 6920 is performance
criteria for Oily Waste Containers.



GREEN SEAL™

This product meets the Green Seal™ standard for institutional hand cleaners based on its reduced human and aquatic toxicity and reduced smog production potential.



HACCP

Hazard Analysis and Critical Control Points is a systematic method using principles (Food Hygiene Practices) for analyzing a food process and determining the possible chemical, physical, and biological hazards within that process that should prevent any unsafe food from leaving the process (this process could be for a food processing plant or food preparation in a restaurant). The seven principles are: 1. Application, 2. HACCP Plan Validation, 3. Quality Manual Review, 4. On-site Readiness Review, 5. Registration Audit, 6. Registration, and, 7. Surveillance.

JOINT COMMISSION

The Joint Commission (formerly known as JCAHO) evaluates and accredits nearly 15,000 health care organizations and programs in the U.S. Joint Commission standards address the organization's level of performance in key functional areas, such as patient rights, patient treatment, and infection control.

US GREEN BUILDING COUNCIL

As a member of the United States Green Building Council, we are dedicated to promoting products for buildings that are environmentally responsible and healthy places to work. We offer over 1,000 products that contribute to buildings achieving LEED Certification. Visit www.rubbermaidcommercial.com for more information on USGBC and LEED Certification.



NFPA

Our Steel and Aluminum products comply with the National Fire Protection Association, Life Safety Code #101, section #31, which states wastebaskets and other waste containers shall be noncombustible.



NSF

National Sanitation Foundation is an independent testing lab/organization in Ann Arbor, Michigan. NSF lists products which meet their criteria for cleanability and sanitation: food contact, splash zone and non-food contact, per Standard 2: Food Equipment and Standard 18: Manual Beverage Dispensers. NSF 3-A USDA for equipment used in processing meat and poultry products. Also, Standard 21: Thermoplastic Refuse Containers.



EU

Regulation (EC) No 1935/2004 of the European Parliament and of the council on materials and articles intended to come into contact with food:
The purpose of this European Union Regulation is to ensure that materials and articles intended to come into contact directly or indirectly with food are safe in design and construction to protect the health of consumers.



OBRA

All UL Listed/ FM Approved Fire-Safe/Self-Extinguishing steel receptacles comply with the following Omnibus Budget Reconciliation Act of 1990 Nursing Home Reform Legislation regulations:

- Quality of Life-483.15(h)(1) Environment
- Dietary Service-483.35(h)(3) Disposal of Garbage and Refuse
- Infection Control-483.65(a) Infection Control Program (c) Storage of Linen
- Physical Environment-483.70(a) Life Safety From Fire (g)(2) Smoking Areas

OSHA

- Decorative Waste products comply with Occupational Safety and Health Administration (OSHA) Standard for Occupational Safety and Health Part 1910.141 Sanitation
- Defenders® Step Cans and Medi-Cans™ comply with OSHA Standard for Bloodborne Pathogens, Final Rule 29CFR, Part 1910.1030

LEGEND



Product is packaged for sale in a retail environment



Indicates Executive Series™ Product



Indicates products made using recycled material and contributes to sustainability



UTILITY REFUSE AND RECYCLING

DECORATIVE REFUSE

CLEANING

MATERIAL HANDLING

WASHROOM

FOODSERVICE

ACCESSORIES
& INDEX



2131929

UTILITY REFUSE AND RECYCLING



1956185 / FG354060BLA / 1955960 / 1955959 / 1956191

BRUTE® UTILITY AND RECYCLING

BRUTE® Utility Containers	12
Waste Stream Label Kits	12
Wheeled BRUTE®	13
BRUTE® Accessories	14
BRUTE® Lids and Tops	15
BRUTE® Square Containers	15

ROLLOUT CONTAINERS

Rollout.....	17
Step-On Rollout	17

SLIM JIM® CONTAINERS AND RECYCLING

Slim Jim® Containers.....	20
Slim Jim® Accessories.....	21
Slim Jim® Under-Counter Containers	22
Slim Jim® Confidential Document Container with Lid	22
Slim Jim® Cleaning Cart Kits.....	23
Slim Jim® Recycling Station 1-Stream Kit.....	26
Slim Jim® Recycling Station.....	28

INDOOR UTILITY CONTAINERS

Streamline™ Step-On Containers.....	31
Legacy Step-On Containers	32
Universal Containers and Tops.....	33
Deskside Waste and Recycling Baskets and Tops	34
Concept Collection™	34
Profile Containers	36
Fire-Resistant Wastebaskets.....	36

RECYCLING

Recycling Boxes	37
Glutton® Recycling Stations	37

STEEL WASTEBASKETS

Steel Wastebasket Open Tops	38
-----------------------------------	----

ACCESSORIES

Can Liners.....	38
Utility Refuse Waste Stream Label Kits.....	39



*Made using resin blend of 20% or more recycled material.

LOOK FOR THE SPECIALLY MARKED **EXECUTIVE SERIES™** PRODUCTS.



UTILITY REFUSE AND RECYCLING

BRUTE® CONTAINERS	12	SLIM JIM® RECYCLING STATION	26
BRUTE® ACCESSORIES	14	STEP-ON CONTAINERS	31
ROLLOUT CONTAINERS	17	UNIVERSAL CONTAINERS AND TOPS	33
SLIM JIM® CONTAINERS	20	DEKSIDAL CONTAINERS & WASTEBASKETS	34
SLIM JIM® ACCESSORIES	21		

When ordering products with **BOLD** color codes, please specify color code after the product number. Refer to the Standard Color Guide at the back of the catalog.

INCREASE

RECYCLING EFFECTIVENESS

**CASE STUDY RESULTED IN HIGH DIVERSION RATE
AND REDUCED CONTAMINATION**

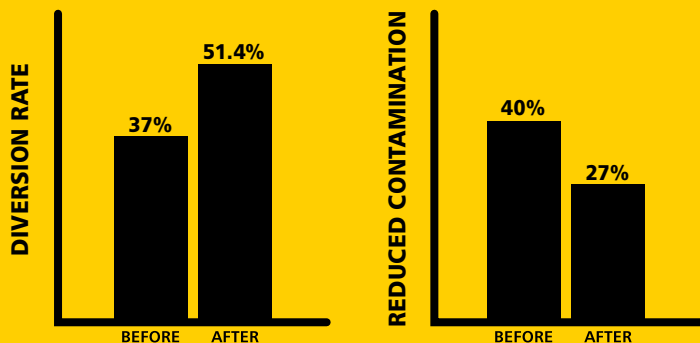

Improving recycling effectiveness has a positive environmental impact, helps facilities achieve sustainability initiatives, and can lead to cost savings. Installing a multi-stream waste disposal system will enable facilities to reduce the amount of waste sent to the landfill.

2019 case study at Michigan State University

BRUTE® UTILITY CONTAINERS

UTILITY REFUSE
AND RECYCLING

DECORATIVE REFUSE

CLEANING

MATERIAL HANDLING

WASHROOM

FOODSERVICE

ACCESSORIES
& INDEX



BRUTE®
TOUGH
WON'T CRACK, CRUSH
OR WARP

BRUTE





COMMERCIAL-GRADE CONSTRUCTION

Proprietary design constructed with the highest quality material plus a UV inhibitor ensures long life in even the most extreme commercial environments.

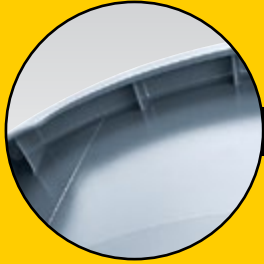

RIM WITH RIB-STRENGTHENED DESIGN

Increases strength and resists crushing.

BAG CINCHES

Secure liners allowing for knot-free liner changes.

ROUNDED HANDLES

Make lifting and moving easy, and are reinforced to resist tearing or damage from even the heaviest loads.

SEAMLESS CONSTRUCTION

Helps make cleaning easy.

VENTING CHANNELS

Make removing liners up to 50% easier, improving productivity and reducing the risk of injury.



CONTOURED BASE HANDLES

Improve grip and ergonomics, reducing strain and improving efficiency when emptying containers.



REINFORCED BASE

Specifically engineered to be dragged over rough surfaces, extending life and durability in even the toughest environments.



UTILITY REFUSE
AND RECYCLING

DECORATIVE REFUSE

CLEANING

MATERIAL HANDLING

WASHROOM

FOODSERVICE

ACCESSORIES
& INDEX



2 & 21 Compliant

BRUTE® Utility Containers

Innovative venting channels make lifting out liners up to 50% easier, improving productivity and reducing the risk of injury.

- Integrated cinches secure the liner, allowing for efficient, knot-free liner changes
- Proprietary design constructed with the highest quality material plus a UV inhibitor ensures long life in even the most extreme commercial environments
- Rounded handles make lifting and moving easy, and are reinforced to resist tearing or damage from even the heaviest loads
- Reinforced base is specifically engineered to be dragged over rough surfaces, extending life and overall durability even in the toughest environments
- Rim features integrated rib structure to increase strength and resist crushing



EXECUTIVE SERIES™
1867531

Available in a wide range of colors and sizes to complement recycling initiatives and all other collection and sortation needs.



BRUTE® Vented Containers

NO.	COLOR	DESCRIPTION	U.S. DIMENSIONS	U.S. CAPACITY	U.S. SHIP WT/CTN	METRIC DIMENSIONS	METRIC CAPACITY	METRIC SHIP WT/CTN	CAN LINERS	PACK
FG261000	GRAY, WHT, RED, YEL, DGRN	BRUTE® Container without Lid	15.6" dia x 17.3" h	10.0 gal	18.5 lb	39.7 cm dia x 43.0 cm	37.9 L	8.4 kg	5003-88	6
1779699	BLUE	BRUTE® Container without Lid	15.6" dia x 17.3" h	10.0 gal	18.5 lb	39.7 cm dia x 43.0 cm	37.9 L	8.4 kg	5003-88	6
1926827	BLACK	BRUTE® Container without Lid	15.6" dia x 17.3" h	10.0 gal	18.5 lb	39.7 cm dia x 43.0 cm	37.9 L	8.4 kg	5003-88	6
FG262000	GRAY, WHT, BLUE, RED, YEL, DGRN	BRUTE® Container without Lid	19.5" dia x 22.9" h	20.0 gal	35.0 lb	49.5 cm dia x 58.1 cm	75.7 L	15.9 kg	5006-88	6
1779734	BLACK	Executive BRUTE® Container without Lid	19.5" dia x 22.9" h	20.0 gal	35.0 lb	49.5 cm dia x 58.1 cm	75.7 L	15.9 kg	5006-88	6
FG263200	GRAY, WHT, BLUE, RED, YEL, DGRN	BRUTE® Container without Lid	22.0" dia x 27.3" h	32.0 gal	47.0 lb	55.9 cm dia x 69.2 cm	121.1 L	21.3 kg	5007-88	6
1867531	BLACK	Executive BRUTE® Container without Lid	22.0" dia x 27.3" h	32.0 gal	47.0 lb	55.9 cm dia x 69.2 cm	121.1 L	21.3 kg	5007-88	6
2119308	ORANGE	BRUTE® Container without Lid	22.0" dia x 27.3" h	32.0 gal	47.0 lb	55.9 cm dia x 69.2 cm	121.1 L	21.3 kg	5007-88	6
FG264360	GRAY, BLUE, RED, YEL, BLA	BRUTE® Container without Lid	24.0" dia x 31.5" h	44.0 gal	49.5 lb	61.0 cm dia x 80.0 cm	166.6 L	22.4 kg	5008-88	4
1779740	WHITE	BRUTE® Container without Lid	24.0" dia x 31.5" h	44.0 gal	49.5 lb	61.0 cm dia x 80.0 cm	166.6 L	22.4 kg	5008-88	4
2119307	ORANGE	BRUTE® Container without Lid	24.0" dia x 31.5" h	44.0 gal	49.5 lb	61.0 cm dia x 80.0 cm	166.6 L	22.4 kg	5008-88	4
1779741	DARK GREEN	BRUTE® Container without Lid	24.0" dia x 31.5" h	44.0 gal	49.5 lb	61.0 cm dia x 80.0 cm	166.6 L	22.4 kg	5008-88	4
FG265500	GRAY, WHT, RED, YEL, DGRN	BRUTE® Container without Lid	26.4" dia x 33.0" h	55.0 gal	52.9 lb	67.0 cm dia x 83.8 cm	208.2 L	24.0 kg	5011-88	3
1779732	BLUE	BRUTE® Container without Lid	26.4" dia x 33.0" h	55.0 gal	52.9 lb	67.0 cm dia x 83.8 cm	208.2 L	24.0 kg	5011-88	3
1779739	BLACK	BRUTE® Container without Lid	26.4" dia x 33.0" h	55.0 gal	52.9 lb	67.0 cm dia x 83.8 cm	208.2 L	24.0 kg	5011-88	3

BRUTE® Recycling

NO.	COLOR	DESCRIPTION	U.S. DIMENSIONS	U.S. CAPACITY	U.S. SHIP WT/CTN	METRIC DIMENSIONS	METRIC CAPACITY	METRIC SHIP WT/CTN	PACK
FG262073*	BLUE	BRUTE® Recycling Container without Lid	19.5" dia x 22.9" h	20.0 gal	35.0 lb	49.5 cm dia x 58.1 cm	75.7 L	15.9 kg	6
FG263273*	BLUE	BRUTE® Recycling Container without Lid	22.0" dia x 27.3" h	32.0 gal	47.0 lb	55.9 cm dia x 69.2 cm	121.1 L	21.3 kg	6
1788472*	GREEN	BRUTE® Recycling Container without Lid	22.0" dia x 27.3" h	32.0 gal	47.0 lb	55.9 cm dia x 69.2 cm	121.1 L	21.3 kg	6
FG264307	BLUE	BRUTE® Recycling Container without Lid	24.0" dia x 31.5" h	44.0 gal	49.5 lb	61.0 cm dia x 80.0 cm	166.6 L	22.4 kg	4

*NSF Standards 2 and 21 do not apply to recycling containers.

Waste Stream Label Kit

Waste Stream Label Kit Version C* (1977787) contain ten intuitive waste stream decals, ensuring waste sortation accuracy.



NO.	COLOR	DESCRIPTION	U.S. DIMENSIONS	PACK
1977787		Waste Stream Label Kit Version C fits 32- and 44-Gallon BRUTE® Containers	9.5" w x 5.7" h	10

When ordering products with **BOLD** color codes, please specify color code after the product number. Refer to the Standard Color Guide at the back of the catalog.

WHEELED BRUTE®

NEVER FLAT WHEELS
The DuraTread never flat wheels allow you to move loads 5X easier* even over rough terrains.



ERGONOMIC HANDLE
Designed to require less force when moving heavy materials of up to 250 lbs.



INTEGRATED TILT & KICK PLATE
Provides maximum leverage for controlled tilting and transporting materials.



BRUTE® TOUGH
Tested for extreme durability to provide superior performance.

NO.	COLOR	DESCRIPTION	U.S. DIMENSIONS	U.S. CAPACITY	U.S. SHIP WT/CTN	METRIC DIMENSIONS	METRIC CAPACITY	METRIC SHIP WT/CTN	PACK
2179403	GRAY	Wheeled BRUTE® 32-Gallon Container	21.9" dia x 34.0" h	32.0 gal	11.0 lb	55.6 cm dia x 86.4 cm	121.1 L	5.0 kg	6
2131929	GRAY	Wheeled BRUTE® 44-Gallon Container	24.0" dia x 36.0" h	44.0 gal	15.5 lb	61.0 cm dia x 91.4 cm	166.6 L	7.0 kg	4
2146547	RED	Replacement Clips							20

*Based on internal testing versus non-wheeled 44G BRUTE® container



BRUTE® Accessories

BRUTE® Dollies

Provide easy mobility and maneuverability when collecting and transporting heavy loads.

QUIET DOLLY



FG264043

TANDEM DOLLY

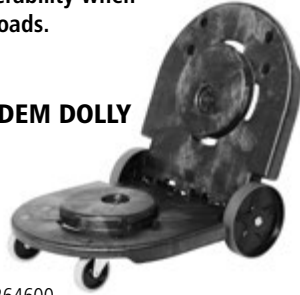

FG264600



NONMARKING CASTERS

Nonmarking casters on the Quiet Dolly eliminate traditional dolly noise across smooth and uneven surfaces.

TWIST LOCK

Secures your BRUTE® container to the BRUTE® Dolly.

DECORATIVE REFUSE

CLEANING

NO.	COLOR	DESCRIPTION	U.S. DIMENSIONS	U.S. CAPACITY	U.S. SHIP WT/CTN	METRIC DIMENSIONS	METRIC CAPACITY	METRIC SHIP WT/CTN	PACK
FG264000	BLA	BRUTE® Dolly for 20-, 32-, 44-, and 55-Gallon BRUTE® Containers	18.2" dia x 6.6" h	250.0 lb	11.4 lb	46.4 cm dia x 16.8 cm	113.3 kg	5.2 kg	2
FG264043	BLA	BRUTE® Quiet Dolly for 20-, 32-, and 44-Gallon BRUTE® Containers	18.2" dia x 6.6" h	250.0 lb	10.8 lb	46.4 cm dia x 16.8 cm	113.3 kg	4.9 kg	2
FG264600	BLA	BRUTE® Tandem Dolly for 20-, 32-, and 44-Gallon BRUTE® Containers	45.0" l x 20.2" w x 8.0" h	200.0 lb per platform	19.0 lb	114.3 cm x 51.4 cm x 20.3 cm	90.7 kg per platform	8.6 kg	1
FG265000	BLA	Universal Drum Dolly for BRUTE® Containers	24.4" dia x 7.1" h	500.0 lb	28.2 lb	61.9 cm dia x 18.1 cm	226.7 kg	12.8 kg	2
FG353000	BLA	BRUTE® Square Dolly for BRUTE® Square Containers	17.2" sq x 6.2" h	300.0 lb	13.5 lb	43.8 cm sq x 15.9 cm	136.07 kg	6.1 kg	2

MATERIAL HANDLING

BRUTE® Rim Caddy

Turn your BRUTE® container into a cleaning cart with storage and transport for spray bottles, wet-floor signs, lobby dust pan, brushes, liners, gloves, and other cleaning supplies.

- Snaps securely onto the rim of BRUTE® 44-Gallon Containers
- Integrated bag straps allow for easy can liner attachment
- User-friendly handle improves maneuverability and minimizes contact with waste
- Durable construction with smooth surfaces for easy cleaning



Holds spray bottles, safety signs, and many other cleaning supplies.

Integrated can liner straps allow easy attachment and removal of can liners.

Efficiently dispense smaller liners from inside the BRUTE® container.

Snap-on tabs keep caddy and accessories in place, even when removing a full liner.

FG9W8700 Rim Caddy shown on FG264360 BRUTE® 44-Gallon Utility Container with Venting Channels, with FG264043 Quiet Dolly and other accessories sold separately.

WASHROOM



FG9W8700



FG264900

NO.	COLOR	DESCRIPTION	U.S. DIMENSIONS	U.S. SHIP WT/CTN	METRIC DIMENSIONS	METRIC SHIP WT/CTN	PACK
FG9W8700	YEL	BRUTE® Rim Caddy for 44-Gallon Containers	32.5" l x 26.5" w x 6.8" h	4.9 lb	82.6 cm x 67.3 cm x 17.1 cm	2.2 kg	1
FG264900	GRAY	Maid Caddy	16.0" l x 9.0" w x 5.0" h	6.5 lb	40.6 cm x 22.9 cm x 12.7 cm	2.9 kg	4

FOODSERVICE

BRUTE® Caddy Bag

Knock out quick cleanups on the go with onboard storage and transport for spray bottles, brushes, liners, gloves, and other supplies.

- Numerous pockets for all your cleaning supplies
- Durable vinyl material for easy cleaning



1867533



FG264200

NO.	COLOR	DESCRIPTION	U.S. DIMENSIONS	U.S. SHIP WT/CTN	METRIC DIMENSIONS	METRIC SHIP WT/CTN	PACK
FG264200	YEL	BRUTE® Caddy Bag for 32- and 44-Gallon BRUTE® Containers	20.0" dia x 20.5" h	10.7 lb	50.8 cm dia x 52.1 cm	4.8 kg	6
⑤ 1867533	BLACK	Executive BRUTE® Caddy Bag for 32- and 44-Gallon BRUTE® Containers	20.0" dia x 20.5" h	10.7 lb	50.8 cm dia x 52.1 cm	4.8 kg	6

ACCESSORIES
& INDEX

When ordering products with **BOLD** color codes, please specify color code after the product number. Refer to the Standard Color Guide at the back of the catalog.

BRUTE® Lids and Tops

Select from a wide range of lids for use in any environment.

SELF-DRAINING LIDS

- Self-draining channels prevent water from pooling, reducing still water buildup
- Snap-lock ensures a secure fit
- Ridges enable stacking of BRUTE® containers to provide a space-efficient storage solution
- Available in 7 colors

DOME TOP LIDS

- Spring action door allows for easy trash disposal while keeping odors in and insects out
- Snap-lock ensures a secure fit

FUNNEL TOP LIDS

- Cut-out top enables hands-free refuse disposal
- Funnel design conceals waste from public view



FG263100GRAY

FG263788GRAY

FG354300GRAY



1788376

BRUTE® RECYCLING LIDS*

- Restrictive lid shape ensures bottles and cans get into the right bins.

NO.	COLOR	DESCRIPTION	U.S. DIMENSIONS	U.S. SHIP WT/CTN	METRIC DIMENSIONS	METRIC SHIP WT/CTN	PACK
FG260900	WHT, GRAY	Lid for 10-Gallon BRUTE® Container	15.9" dia x 1.2" h	4.7 lb	40.4 cm dia x 3.0 cm	2.1 kg	6
FG261960	WHT, RED, GRAY, BLA	Lid for 20-Gallon BRUTE® Container	19.8" dia x 1.7" h	7.1 lb	50.5 cm dia x 4.3 cm	3.2 kg	6
1779731	BLUE	Lid for 20-Gallon BRUTE® Container	19.8" dia x 1.7" h	7.1 lb	50.5 cm dia x 4.3 cm	3.2 kg	6
FG263100	YEL, WHT, RED, GRAY, BLUE	Lid for 32-Gallon BRUTE® Container	22.2" dia x 1.6" h	12.3 lb	56.5 cm dia x 4.1 cm	5.6 kg	6
1867532	BLACK	Executive Lid for 32-Gallon BRUTE® Container	22.2" dia x 1.6" h	12.3 lb	56.5 cm dia x 4.1 cm	5.6 kg	6
FG264560	WHT, RED, GRAY, BLA	Lid for 44-Gallon BRUTE® Container	27.5" dia x 2.0" h	14.3 lb	69.8 cm dia x 5.0 cm	6.5 kg	4
1779636	BLUE	Lid for 44-Gallon BRUTE® Container	27.5" dia x 2.0" h	14.3 lb	69.8 cm dia x 5.0 cm	6.5 kg	4
FG265400	WHT, RED, GRAY	Lid for 55-Gallon BRUTE® Container	29.1" dia x 3.0" h	11.6 lb	68.4 cm dia x 7.4 cm	5.3 kg	3
1779733	BLUE	Lid for 55-Gallon BRUTE® Container	29.1" dia x 3.0" h	11.6 lb	73.9 cm dia x 7.6 cm	5.3 kg	3
1779738	BLACK	Executive Lid for 55-Gallon BRUTE® Container	29.1" dia x 3.0" h	11.6 lb	73.9 cm dia x 7.6 cm	5.3 kg	3
FG263788	GRAY, RED	BRUTE® Dome Top for 32-Gallon BRUTE® Container	22.6" dia x 12.2" h	9.8 lb	57.6 cm dia x 31.1 cm	4.4 kg	1
1829397	GREEN	BRUTE® Dome Top for 32-Gallon BRUTE® Container	22.6" dia x 12.2" h	9.8 lb	57.6 cm dia x 31.1 cm	4.4 kg	1
1829398	BLUE	BRUTE® Dome Top for 32-Gallon BRUTE® Container	22.6" dia x 12.2" h	9.8 lb	57.6 cm dia x 31.1 cm	4.4 kg	1
2044152	BLACK	BRUTE® Dome Top for 32-Gallon BRUTE® Container	22.6" dia x 12.2" h	9.8 lb	57.6 cm dia x 31.1 cm	4.4 kg	1
FG264788	GRAY, RED	BRUTE® Dome Top for 44-Gallon BRUTE® Container	24.8" dia x 12.6" h	12.1 lb	63.0 cm dia x 32.1 cm	5.5 kg	1
1834840	BLUE	BRUTE® Dome Top for 44-Gallon BRUTE® Container	24.8" dia x 12.3" h	12.1 lb	63.0 cm dia x 32.1 cm	5.5 kg	1
2044039	BLACK	BRUTE® Dome Top for 44-Gallon BRUTE® Container	24.8" dia x 12.3" h	12.1 lb	63.0 cm dia x 32.1 cm	5.5 kg	1
FG265788	GRAY, RED	BRUTE® Dome Top for 55-Gallon BRUTE® Container	27.2" dia x 15.5" h	13.0 lb	69.2 cm dia x 39.3 cm	5.9 kg	1
2044040	BLACK	BRUTE® Dome Top for 55-Gallon BRUTE® Container	27.2" dia x 15.5" h	13.0 lb	69.2 cm dia x 39.3 cm	5.9 kg	1
FG354300 ¹	GRAY	Funnel Top for 32-Gallon BRUTE® Containers	22.3" dia x 5.0" h	8.8 lb	56.8 cm dia x 12.7 cm	4.0 kg	4
1788376	BLUE	BRUTE® 32G Lid - Bottles/Cans	22.5" dia x 3.2" h	10.9 lb	57.2 cm dia x 8.1 cm	5.0 kg	6

¹ Provides hands-free product use.

* NSF Standard 2 and NSF Standard 21 Certification applies to BRUTE® Self-Draining Lids.

BRUTE® Square Containers

Increased capacity for storage or refuse collection.

- Square shape offers up to 27% more capacity than round containers
- Tight-fitting indented lid design helps protect dry goods and other contents, while facilitating stacking during transportation and storage
- Nesting handles allow secure fit in side-by-side use
- Gray and white are USDA Meat and Poultry Equipment Group listed and assist in complying with HACCP guidelines
- Certified to NSF Std. #2 (Red, Gray, and White) and Std. #21 (Gray and White)



FG352600



FG352900

NO.	COLOR	DESCRIPTION	U.S. DIMENSIONS	U.S. CAPACITY	U.S. SHIP WT/CTN	METRIC DIMENSIONS	METRIC CAPACITY	METRIC SHIP WT/CTN	PACK
FG352600	RED, GRAY	BRUTE® Square Container without Lid	25.1" w x 22.5" h	28.0 gal	54.0 lb	63.8 cm x 57.2 cm	106.0 L	24.5 kg	6
FG353600	GRAY	BRUTE® Square Container without Lid	27.0" w x 28.8" h	40.0 gal	51.2 lb	68.6 cm x 73.0 cm	151.4 L	23.2 kg	4
FG352700	GRAY	Lid for FG352600 Container	24.3" w x 2.0" h	N/A	16.8 lb	61.6 cm x 5.1 cm	N/A	7.6 kg	6
FG353900	GRAY	Lid for FG353600 Container	26.0" sq x 2.0" h	N/A	15.3 lb	66.0 cm x 5.1 cm	N/A	6.9 kg	4
FG352900	RED	Snap-Lock® Lid for FG352600 Container	21.9" x 2.1" h	N/A	16.8 lb	55.6 cm x 5.4 cm	N/A	7.6 kg	6



ROLLOUT CONTAINERS

UTILITY REFUSE
AND RECYCLING

DECORATIVE REFUSE

CLEANING

MATERIAL HANDLING

WASHROOM

FOODSERVICE

ACCESSORIES
& INDEX



**HANDS-FREE
LID OPERATION**

DESIGNED TO HELP PROMOTE PRODUCTIVITY With just a step, the pedal lifts the lid, eliminating the need to keep one hand free to hold the lid open.

Rollout Containers

Easy mobility for material handling, general refuse, and bulk waste collection.

- Available in 32-Gallon, 50-Gallon, 65-Gallon, and 95-Gallon capacities for improved productivity
- Heavy-duty wheels with high-performance treads are optimized for use indoors and outdoors
- Reinforced rim for superior structural integrity and robust lid designed for added strength
- Rollout lids open fully and stay in place to prevent swinging during transport
- Compliant with ANSI Standard Z245.60 (Types B and G) for compatibility with auto-lifters
- Smooth contours and seamless construction make cleaning easier and quicker, to improve staff productivity
- Designed with an ergonomic handle for comfortable push or pull operation
- High-quality materials plus a UV inhibitor extend the life of the container



1971941



FG9W2773BLUE

DECORATIVE REFUSE

Standard Rollout Containers

NO.	COLOR	DESCRIPTION	U.S. DIMENSIONS	U.S. CAPACITY	U.S. SHIP WT/CTN	METRIC DIMENSIONS	METRIC CAPACITY	METRIC SHIP WT/CTN	PACK
1971941	GRAY	Standard Rollout Container	28.6" l x 20.6" w x 37.1" h	32.0 gal	34.0 lb	72.5 cm x 52.4 cm x 94.4 cm	120.0 L	15.4 kg	2
1971943	BLUE	Standard Rollout Container	28.6" l x 20.6" w x 37.1" h	32.0 gal	34.0 lb	72.5 cm x 52.4 cm x 94.4 cm	120.0 L	15.4 kg	2
FG9W2700	YEL, GRAY, BLUE	Standard Rollout Container	28.5" l x 23.4" w x 36.5" h	50.0 gal	39.0 lb	72.4 cm x 59.4 cm x 92.7 cm	189.3 L	17.7 kg	2
1829411	GREEN	Standard Rollout Container	28.5" l x 23.4" w x 36.5" h	50.0 gal	39.0 lb	72.4 cm x 59.4 cm x 92.7 cm	189.3 L	17.7 kg	2
FG9W2100	GRAY	Standard Rollout Container	32.3" l x 25.3" w x 44.7" h	65.0 gal	33.5 lb	82.0 cm x 64.3 cm x 113.5 cm	246.1 L	15.2 kg	1
FG9W2200	GRAY	Standard Rollout Container	37.2" l x 28.6" w x 46.0" h	95.0 gal	38.5 lb	94.3 cm x 72.6 cm x 116.8 cm	359.6 L	17.5 kg	1
FG9W2273	BLUE	Standard Rollout Container	37.2" l x 28.6" w x 46.0" h	95.0 gal	38.5 lb	94.3 cm x 72.6 cm x 116.8 cm	359.6 L	17.5 kg	1

CLEANING

Recycling Rollout Containers

NO.	COLOR	DESCRIPTION	U.S. DIMENSIONS	U.S. CAPACITY	U.S. SHIP WT/CTN	METRIC DIMENSIONS	METRIC CAPACITY	METRIC SHIP WT/CTN	PACK
FG9W2773	BLUE	Recycling Rollout Container with Lid	28.5" l x 23.4" w x 36.5" h	50.0 gal	43.6 lb	72.4 cm x 59.4 cm x 92.7 cm	189.3 L	19.8 kg	2

MATERIAL HANDLING

Step-On Rollout Containers

Step-On Rollout Containers are designed to make managing facility waste easier. With one step, the pedal lifts the lid and allows for hands-free waste disposal.



1971944



1971956



1971968

WASHROOM

NO.	COLOR	DESCRIPTION	U.S. DIMENSIONS	U.S. CAPACITY	U.S. SHIP WT/CTN	METRIC DIMENSIONS	METRIC CAPACITY	METRIC SHIP WT/CTN	PACK
1971944	GRAY	Step-On Rollout Container	28.6" l x 20.6" w x 37.2" h	32.0 gal	19.2 lb	72.5 cm x 52.4 cm x 94.4 cm	120.0 L	8.7 kg	1
1971956	GRAY	Step-On Rollout Container	30.1" l x 24.0" w x 39.6" h	50.0 gal	27.0 lb	76.4 cm x 60.9 cm x 100.5 cm	189.0 L	12.2 kg	1
1971968	GRAY	Step-On Rollout Container	32.3" l x 25.3" w x 44.7" h	65.0 gal	35.5 lb	82.1 cm x 64.3 cm x 113.6 cm	246.0 L	16.1 kg	1

FOODSERVICE

SLIM JIM® CONTAINERS

UTILITY REFUSE
AND RECYCLING

DECORATIVE REFUSE

CLEANING

MATERIAL HANDLING

WASHROOM

FOODSERVICE

80% EASIER
BAG REMOVAL
WITH BUILT IN VENTING CHANNELS

The Slim Jim® container is designed with four built-in venting channels that create airflow throughout the container. This air circulation reduces the vacuum effect that occurs when lifting out liners in traditional containers. By reducing the pull force required to lift out liners by up to 80%, the Slim Jim® container improves productivity and reduces the risk of injury.

ACCESSORIES
& INDEX

IMPROVED PRODUCTIVITY



SlimJim®

UTILITY REFUSE
AND RECYCLING



VENTING CHANNELS

Make removing liners up to 80% easier, improving productivity and reducing the risk of worker injury.



BAG CINCHES

Secure liners around the rim of the container and allow for quick, knot-free liner changes.



BASE AND RIM HANDLES

Improve grip and control while lifting and emptying full containers.



MULTIPLE DOLLY OPTIONS

Allow for efficient collection and transportation of Slim Jim® containers.



DECORATIVE REFUSE

CLEANING

MATERIAL HANDLING

WASHROOM

FOODSERVICE

ACCESSORIES
& INDEX

Slim Jim® Containers

Slim Jim® Containers with Venting Channels
Slim Jim® Containers with Venting Channels deliver the most space-efficient solution for collection, transportation, and disposal of multi-stream waste and recyclables.

- Venting channels make removing liners up to 80% easier, improving productivity and reducing the risk of worker injury*
- Four bag cinches secure liners around the rim of the container and allow for quick, knot-free liner changes
- Handles at the base and rim of the container improve grip and control while lifting and emptying full containers
- Rim with rib-strengthened design increases strength and resists crushing
- Build a recycling station with a variety of dolly and lid options to meet any facility need



1971258

FG354060GRAY



Can Liner Cinches

Four pull-through holes and can liner cinches eliminate knot tying.



1956185

1956186

1956187

1956188

1956189

FG354060BLA

FG354060BEIG

NO.	COLOR	DESCRIPTION	U.S. DIMENSIONS	U.S. CAPACITY	U.S. SHIP WT/CTN	METRIC DIMENSIONS	METRIC CAPACITY	METRIC SHIP WT/CTN	PACK
1971258	GRAY	Slim Jim® Container with Venting Channels	22.0" l x 11.0" w x 25.0" h	16.0 gal	26.0 lb	55.9 cm x 27.9 cm x 63.5 cm	60.6 L	11.8 kg	4
1971259	BEIGE	Slim Jim® Container with Venting Channels	22.0" l x 11.0" w x 25.0" h	16.0 gal	26.0 lb	55.9 cm x 27.9 cm x 63.5 cm	60.6 L	11.8 kg	4
1956181	BROWN	Slim Jim® Container with Venting Channels	22.0" l x 11.0" w x 25.0" h	16.0 gal	26.0 lb	55.9 cm x 27.9 cm x 63.5 cm	60.6 L	11.8 kg	4
1971257	BLUE	Slim Jim® Container with Venting Channels	22.0" l x 11.0" w x 25.0" h	16.0 gal	26.0 lb	55.9 cm x 27.9 cm x 63.5 cm	60.6 L	11.8 kg	4
1955960	GREEN	Slim Jim® Container with Venting Channels	22.0" l x 11.0" w x 25.0" h	16.0 gal	26.0 lb	55.9 cm x 27.9 cm x 63.5 cm	60.6 L	11.8 kg	4
1955959	BLACK	Slim Jim® Container with Venting Channels	22.0" l x 11.0" w x 25.0" h	16.0 gal	26.0 lb	55.9 cm x 27.9 cm x 63.5 cm	60.6 L	11.8 kg	4
FG354060**	GRAY, BEIG, BLA	Slim Jim® Container with Venting Channels	22.0" l x 11.0" w x 30.0" h	23.0 gal	31.8 lb	55.9 cm x 27.9 cm x 76.2 cm	87.1 L	14.4 kg	4
1956187	BROWN	Slim Jim® Container with Venting Channels	22.0" l x 11.0" w x 30.0" h	23.0 gal	31.8 lb	55.9 cm x 27.9 cm x 76.2 cm	87.1 L	14.4 kg	4
1956185	BLUE	Slim Jim® Container with Venting Channels	22.0" l x 11.0" w x 30.0" h	23.0 gal	31.8 lb	55.9 cm x 27.9 cm x 76.2 cm	87.1 L	14.4 kg	4
1956189	RED	Slim Jim® Container with Venting Channels	22.0" l x 11.0" w x 30.0" h	23.0 gal	31.8 lb	55.9 cm x 27.9 cm x 76.2 cm	87.1 L	14.4 kg	4
1956188	YELLOW	Slim Jim® Container with Venting Channels	22.0" l x 11.0" w x 30.0" h	23.0 gal	31.8 lb	55.9 cm x 27.9 cm x 76.2 cm	87.1 L	14.4 kg	4
1956186	GREEN	Slim Jim® Container with Venting Channels	22.0" l x 11.0" w x 30.0" h	23.0 gal	31.8 lb	55.9 cm x 27.9 cm x 76.2 cm	87.1 L	14.4 kg	4
FG354007	BLUE, GRN	Slim Jim® Container with Venting Channels – Recycling	22.0" l x 11.0" w x 30.0" h	23.0 gal	31.8 lb	55.9 cm x 27.9 cm x 76.2 cm	87.1 L	14.4 kg	4

*Based on internal testing.

**Custom imprinting available; contact Rubbermaid Customer Service at (800) 347-9800 for details.

DECORATIVE REFUSE

CLEANING

MATERIAL HANDLING

WASHROOM

FOODSERVICE

Slim Jim® Accessories

Slim Jim® Accessories promote recycling, improve productivity, and make mobile waste collection and cleaning in tight spaces easier than ever. Mix and match Slim Jim® accessories, containers, and dollies to suit any space.

Stainless Steel Dollies

- Collect and transport multiple streams of waste and recyclables with the new stainless steel multi-dollies for Slim Jim® containers
- Constructed from high quality stainless steel material that is easy to clean and won't rust or chip in commercial environments
- Features 3" nonmarking quiet casters that allow for smooth and quiet maneuverability
- Locking feature on casters creates a stable recycling station or collection site
- Fits both 16- and 23-gallon Slim Jim® Vented Containers

Resin Trainable Dolly

- Features a side clip-on connection that allows you to train several dollies together for collection and transportation purposes
- Foot pedal release makes disconnecting dollies quick and easy
- Structural foam construction ensures maximum durability in commercial environments
- Fits both 16- and 23-gallon Slim Jim® Vented Containers



1968468



1956191



1980602

NO	COLOR	DESCRIPTION	U.S. DIMENSIONS	U.S. CAPACITY	U.S. SHIP WT/CTN	METRIC DIMENSIONS	METRIC CAPACITY	METRIC SHIP WT/CTN	PACK
1968468	STAINLESS	Slim Jim® Stainless Steel Dolly for Slim Jim® Containers – Single	20.0" l x 9.3" w x 9.0" h	100.0 lb	11.6 lb	50.8 cm x 23.6 cm x 22.9 cm	45.4 kg	5.2 kg	2
1956191	STAINLESS	Slim Jim® Stainless Steel Dolly for Slim Jim® Containers – Double	20.0" l x 20.6" w x 9.0" h	200.0 lb	9.9 lb	50.8 cm x 52.3 cm x 22.9 cm	90.7 kg	4.5 kg	1
1980602	BLACK	Slim Jim® Resin Trainable Dolly for Slim Jim® Containers	23.9" l x 14.7" w x 8.4" h	120.0 lb	11.9 lb	60.7 cm x 37.3 cm x 21.3 cm	54.4 kg	5.4 kg	2

Slim Jim® Lids

- Encourage waste separation and recycling with interchangeable, color-coded lids
- Swing Lid conceals waste from view and provides no-touch access
- Hinged Lid folds flat while in use and completely covers waste when closed; complies with Health and Human Services Standard



Handle Top Lid
FG268888LGRAY



Swing Lid
FG267360GRAY



Bottles and Cans Lid
FG269288BLUE



Hinged Lid
FG267400BLA

NO.	COLOR	DESCRIPTION	U.S. DIMENSIONS	U.S. SHIP WT/CTN	PACK
FG268888L	GRAY	Slim Jim® Handle Top	20.4" l x 11.2" w x 3.8" h	4.1 lb	4
FG267360	BEIG, BLA, BLUE, GRAY	Slim Jim® Swing Lid for Slim Jim® Containers	20.5" l x 11.7" w x 5.0" h	12.5 lb	4
1829400	GREEN	Slim Jim® Swing Lid for Slim Jim® Containers	20.5" l x 11.4" w x 5.0" h	12.5 lb	4
FG269288	BLUE, GRN	Slim Jim® Bottles and Cans Recycling Lid for Slim Jim® Containers	20.4" l x 11.3" w x 2.8" h	3.9 lb	4
FG270388	BLUE	Slim Jim® Paper Recycling Lid for Slim Jim® Containers	20.5" l x 11.5" w x 2.8" h	4.1 lb	4
1788372	BLUE	Slim Jim® Mixed Recycling Lid for Slim Jim® Containers	21.1" l x 12.1" w x 2.8" h	5.4 lb	4
1788373	GREEN	Slim Jim® Mixed Recycling Lid for Slim Jim® Containers	20.5" l x 11.5" w x 2.8" h	4.1 lb	4
FG267400	BLA	Executive Slim Jim® Hinged Lid for Slim Jim® Containers	21.0" l x 13.5" w x 1.2" h	6.5 lb	4

DECORATIVE REFUSE

CLEANING

MATERIAL HANDLING

WASHROOM

FOODSERVICE

Slim Jim® Under-Counter Containers

A purpose-built solution for space-efficient waste disposal under the counter.

- Large angled opening provides 2X more access under the counter than traditional slim containers
- Integrated venting channels make removing liners 80% easier, improving productivity and reducing the risk of worker injury
- Commercial-grade construction with high-quality resin material
- Bag cinches secure liners around the rim of the container and allow for quick, knot-free liner changes
- Rim and base handles improve grip and control while lifting and emptying full containers
- Reinforced rim maintains structural integrity to resist crushing
- Slim Jim® Under-Counter containers fit any space or need



2026695



2026721

NO.	COLOR	DESCRIPTION	U.S. DIMENSIONS	U.S. CAPACITY	U.S. SHIP WT/CTN	METRIC DIMENSIONS	METRIC CAPACITY	METRIC SHIP WT/CTN	PACK
2026695	GRAY	Slim Jim® Under-Counter Container	22.2" l x 11.2" w x 26.1" h	13.0 gal	30.7 lb	56.5 cm x 28.4 cm x 66.3 cm	49.0 L	13.9 kg	4
2026721	GRAY	Slim Jim® Under-Counter Container	22.1" l x 15.8" w x 30.0" h	23.0 gal	41.7 lb	56.0 cm x 40.1 cm x 76.2 cm	87.0 L	18.9 kg	4

Slim Jim® Confidential Document Container with Lid

Keeps sensitive documents secure.

- Locking lid prevents unauthorized entry.
- Side entry paper slot allows placement under desks



FG9W2500LGRAY



FG9W1500LGRAY

NO.	COLOR	DESCRIPTION	U.S. DIMENSIONS	U.S. CAPACITY	U.S. SHIP WT/CTN	METRIC DIMENSIONS	METRIC CAPACITY	METRIC SHIP WT/CTN	PACK
FG9W2500LGRAY	GRAY	Slim Jim® Confidential Document Container with Lid	24.5" l x 11.0" w x 26.8" h	16.0 gal	30.3 lb	62.2 cm x 27.9 cm x 60.1 cm	60.6 L	13.7 kg	4
FG9W1500LGRAY	GRAY	Slim Jim® Confidential Document Container with Lid	24.5" l x 11.0" w x 30.0" h	23.0 gal	37.0 lb	62.2 cm x 27.9 cm x 76.2 cm	87.1 L	17.7 kg	4

Slim Jim® Cleaning Cart Kit

Slim Jim® Cleaning Carts make mobile waste collection and cleaning in tight spaces easier than ever

- Rim Caddy fits securely on the rim of a Slim Jim® container, allowing for the storage and transportation of common cleaning tools. The Slim Jim® Rim Caddy features an integrated dustpan holder, dedicated hooks to hold a safety sign, and space for storing up to 3 spray bottles
- Rim Caddies can be linked together for efficient multi-stream waste collection
- Each Slim Jim® Rim Caddy includes a Stick Clip, Wide Hook, and Peg Hook that can be arranged into hundreds of different configurations onto five dedicated tool rails
- Commercial-grade construction with high-quality resin material



UTILITY REFUSE
AND RECYCLING

DECORATIVE REFUSE

CLEANING

MATERIAL HANDLING

WASHROOM

FOODSERVICE

ACCESSORIES
& INDEX

NO	COLOR	DESCRIPTION	PARTS INCLUDED	U.S. DIMENSIONS	U.S. SHIP WT/CTN	METRIC DIMENSIONS	METRIC SHIP WT/CTN	PACK
2032953	BLACK	Slim Jim® Cleaning Cart Kit	Rim Caddy, Stick Clip, Wide Hook, Peg Hook, 23G Black Vented Slim Jim® Container, Resin Trainable Dolly	34.3" l x 14.1" w x 35.8" h	22.4 lb	87.1 cm x 35.9 cm x 90.8 cm	10.2 kg	1

ADAPTABLE

RECYCLING SOLUTIONS

Building an effective zero waste system requires consistent processes and products throughout a facility. Having consistent color-coding, lid openings, and waste stream labels across collection and movement products is essential to increasing recycling and composting effectiveness.





4 COLOR BILLBOARD OPTIONS

Color-coding creates consistent visual cues for patrons and staff when sorting recyclables.



Blue Green Yellow Black



4 LID OPTIONS

Restrictive lid shapes ensure the right recyclables get into the right bins. For an open top option, no insert needed.



Mixed Recycling Paper Bottles/Cans Landfill



10 WASTE STREAM LABELS

Expert designed waste stream labels feature 3 visual cues: the recycling symbol, a waste stream icon and verbiage proven to increase recycling effectiveness.



Slim Jim® Recycling Station

Mix and match 1-stream kits (Option 1), select a pre-made kit (Option 2), or create your own station (Option 3) by selecting from the offerings of lid inserts, billboards, and waste stream labels, in combination with a starter kit.

Slim Jim® Recycling Station – 1-Stream Kit (Option 1)

1-Stream Kits are designed to mix and match to create a customized recycling station system

- 23G and 33G containers connect seamlessly with an included connector for increased customization
- All 1-Stream Kits include a Base, Lid Shroud, Lid Insert, Billboard, Connector and Label Kit
- Intuitive lid openings help patrons and staff sort recyclables more effectively



2185053 2185055 2185051



2171554 2171557 2171555

NO.	COLOR	DESCRIPTION	U.S. DIMENSIONS	U.S. CAPACITY	U.S. SHIP WT/CTN	METRIC DIMENSIONS	METRIC SHIP WT/CTN	PACK
2185053	BLACK	1-Stream 23 Gallon Landfill Kit	21.3" l x 12.3" w x 30.6" h	23.0 gal	11.8 lb	54.1 cm x 30.8 cm x 77.8 cm	5.3 kg	1
2185055	BLUE	1-Stream 23 Gallon Mixed Recycling Kit	21.3" l x 12.3" w x 30.6" h	23.0 gal	11.8 lb	54.1 cm x 30.8 cm x 77.8 cm	5.3 kg	1
2185051	GREEN	1-Stream 23 Gallon Compost Kit	21.3" l x 12.3" w x 30.6" h	23.0 gal	11.8 lb	54.1 cm x 30.8 cm x 77.8 cm	5.3 kg	1
2185052	YELLOW	1-Stream 23 Gallon Bottles/Cans Kit	21.3" l x 12.3" w x 30.6" h	23.0 gal	11.8 lb	54.1 cm x 30.8 cm x 77.8 cm	5.3 kg	1
2185054	GREEN	1-Stream 23 Gallon Paper Kit	21.3" l x 12.3" w x 30.6" h	23.0 gal	11.8 lb	54.1 cm x 30.8 cm x 77.8 cm	5.3 kg	1
2171554	BLACK	1-Stream 33 Gallon Landfill Kit	21.8" l x 19.8" w x 31.3" h	33.0 gal	12.6 lb	55.2 cm x 50.2 cm x 79.4 cm	7.6 kg	1
2171557	BLUE	1-Stream 33 Gallon Mixed Recycling Kit	21.8" l x 19.8" w x 31.3" h	33.0 gal	12.6 lb	55.2 cm x 50.2 cm x 79.4 cm	7.6 kg	1
2171555	GREEN	1-Stream 33 Gallon Compost Kit	21.8" l x 19.8" w x 31.3" h	33.0 gal	12.6 lb	55.2 cm x 50.2 cm x 79.4 cm	7.6 kg	1

DECORATIVE REFUSE

CLEANING

MATERIAL HANDLING

WASHROOM

FOODSERVICE



UTILITY REFUSE
AND RECYCLING

DECORATIVE REFUSE

CLEANING

MATERIAL HANDLING

WASHROOM

FOODSERVICE

ACCESSORIES
& INDEX

2171554 / 2171555 / 2185055

Slim Jim® Recycling Station – Pre-Made Kits (Option 2)

Select from a variety of pre-determined multi-stream stations to fit your unique recycling needs.

- Intuitive lid openings help patrons and staff sort recyclables more effectively
- Provide better waste stream visibility by selecting a color and waste stream label for your facility needs
- Hinging lid inserts are optimized to fit any size recyclable
- Simple and durable execution. Components snap in place without the use of hardware
- Waste Stream Label Kit is included in the Recycling Kit



NO.	COLOR	DESCRIPTION	U.S. DIMENSIONS	U.S. CAPACITY	U.S. SHIP WT/CTN	METRIC DIMENSIONS	METRIC SHIP WT/CTN	PACK
2007914	BLACK/BLUE	2-Stream Station Landfill/Mixed Recycling	21.5" l x 24.0" w x 40.3" h	23.0 gal/23.0 gal	12.5 lb	54.6 cm x 60.9 cm x 102.3 cm	5.6 kg	1
2007917	BLACK/BLUE/YELLOW	3-Stream Station Landfill/Paper/Bottles/Cans	21.5" l x 36.0" w x 40.3" h	23.0 gal/23.0 gal/23.0 gal	37.1 lb	54.6 cm x 91.4 cm x 102.3 cm	16.8 kg	1
2007918	BLACK/BLUE/GREEN	3-Stream Station Landfill/Mixed Recycling/Compost	21.5" l x 36.0" w x 40.3" h	23.0 gal/23.0 gal/23.0 gal	37.1 lb	54.6 cm x 91.4 cm x 102.3 cm	16.8 kg	1
2007919	BLACK/BLUE/RED/YELLOW	4-Stream Station Landfill/Paper/Plastic/Cans	21.5" l x 48.0" w x 40.3" h	23.0 gal/23.0 gal/23.0 gal/23.0 gal	47.3 lb	54.6 cm x 121.9 cm x 102.3 cm	21.5 kg	1

Slim Jim® Recycling Station – Create Your Own Station Starter Kit (Option 3)

An adaptable recycling solution offers a front-of-house look with back-of-house functionality.

- Starter Kit includes a base, lid, and connector. Lid Inserts and Billboards sold separately
- You will need as many starter kits as streams you want in your station
- Intuitive lid openings help patrons and staff sort recyclables more effectively
- Provide better waste stream visibility by selecting a color and waste stream label for your facility needs.
- Hinging lid inserts are optimized to fit any size recyclable
- Simple and durable execution. Components snap in place without the use of hardware



1 SELECT A STARTER KIT
Build your own station by selecting the starter kit: A Base, Lid, and Connector.



2 CHOOSE A LID INSERT
Choose your color and opening type: Mixed Recycle, Paper, Bottles/Cans, and Closed.



3 COORDINATE THE BILLBOARD
Choose the color to match your lid inserts: Blue, Red, Yellow, Green, Brown, Dark Gray, and Black.



4 ADD A WASTE STREAM LABEL
Choose from ten waste stream labels to complete the station.



NO.	COLOR	DESCRIPTION	U.S. DIMENSIONS	U.S. CAPACITY	U.S. SHIP WT/CTN	METRIC DIMENSIONS	METRIC SHIP WT/CTN	PACK
2007913	LIGHT GRAY	23G Starter Kit	21.5" l x 12.0" w x 34.3" h	23.0 gal	11.8 lb	54.6 cm x 30.5 cm x 87.1 cm	5.4 kg	1
2171553	LIGHT GRAY	33G Starter Kit	21.8" l x 19.8" w x 31.3" h	33.0 gal	15.6 lb	55.2 cm x 50.2 cm x 79.4 cm	7.1 kg	1

Slim Jim® Recycling Station – Lid Inserts

- Intuitive lid openings help patrons and staff sort recyclables more effectively
- Hinging lid inserts are optimized to fit any size recyclable
- Components snap in place without the use of hardware
- Compatible with Slim Jim® Recycling Station Starter Kit



NO.	COLOR	DESCRIPTION	U.S. SHIP WT/CTN	U.S. DIMENSIONS	METRIC SHIP WT/CTN	PACK
2007192	RED	Closed Lid Insert	0.8 lb	16.5" l x 8.0" w x 0.5" h	0.3 kg	1
2007194	RED	Paper Slot Lid Insert	0.8 lb	16.5" l x 8.0" w x 0.5" h	0.3 kg	1
2007881	YELLOW	Bottles/Cans Lid Insert	0.8 lb	16.5" l x 8.0" w x 0.5" h	0.3 kg	1
2007882	YELLOW	Paper Slot Lid Insert	0.8 lb	16.5" l x 8.0" w x 0.5" h	0.3 kg	1
2007883	YELLOW	Mixed Recycling Lid Insert	0.8 lb	16.5" l x 8.0" w x 0.5" h	0.3 kg	1
2007884	GREEN	Closed Lid Insert	0.8 lb	16.5" l x 8.0" w x 0.5" h	0.3 kg	1
2007885	GREEN	Bottles/Cans Lid Insert	0.8 lb	16.5" l x 8.0" w x 0.5" h	0.3 kg	1
2007886	GREEN	Paper Slot Lid Insert	0.8 lb	16.5" l x 8.0" w x 0.5" h	0.3 kg	1
2007887	GREEN	Mixed Recycling Lid Insert	0.8 lb	16.5" l x 8.0" w x 0.5" h	0.3 kg	1
2007888	BLUE	Closed Lid Insert	0.8 lb	16.5" l x 8.0" w x 0.5" h	0.3 kg	1
2007889	BLUE	Bottles/Cans Lid Insert	0.8 lb	16.5" l x 8.0" w x 0.5" h	0.3 kg	1
2007890	BLUE	Paper Slot Lid Insert	0.8 lb	16.5" l x 8.0" w x 0.5" h	0.3 kg	1
2007891	BLUE	Mixed Recycling Lid Insert	0.8 lb	16.5" l x 8.0" w x 0.5" h	0.3 kg	1
2007892	BLACK	Closed Lid Insert	0.8 lb	16.5" l x 8.0" w x 0.5" h	0.3 kg	1
2007893	BLACK	Bottles/Cans Lid Insert	0.8 lb	16.5" l x 8.0" w x 0.5" h	0.3 kg	1
2007894	BLACK	Paper Slot Lid Insert	0.8 lb	16.5" l x 8.0" w x 0.5" h	0.3 kg	1
2007895	BLACK	Mixed Recycling Lid Insert	0.8 lb	16.5" l x 8.0" w x 0.5" h	0.3 kg	1
2007897	DARK GRAY	Bottles/Cans Lid Insert	0.8 lb	16.5" l x 8.0" w x 0.5" h	0.3 kg	1
2007899	DARK GRAY	Mixed Recycling Lid Insert	0.8 lb	16.5" l x 8.0" w x 0.5" h	0.3 kg	1
2007900	BROWN	Closed Lid Insert	0.8 lb	16.5" l x 8.0" w x 0.5" h	0.3 kg	1
2007903	BROWN	Paper Slot Lid Insert	0.8 lb	16.5" l x 8.0" w x 0.5" h	0.3 kg	1

Slim Jim® Recycling Station – Billboard

- Provide better waste stream visibility by selecting a color and waste stream label for your facility needs
- Components snap in place without the use of hardware
- Compatible with Slim Jim® Recycling Station Starter Kit, Slim Jim® Recycling Station lid inserts, and Slim Jim® Recycling Station Waste Stream label kits

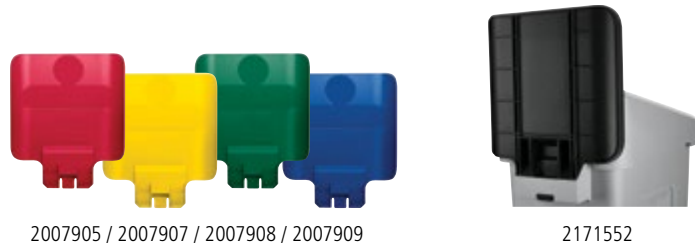

2007905 / 2007907 / 2007908 / 2007909

2171552

NO.	COLOR	DESCRIPTION	U.S. DIMENSIONS	U.S. SHIP WT/CTN	METRIC DIMENSIONS	METRIC SHIP WT/CTN	PACK
2007905	RED	23G Billboard	1.8" l x 11.8" w x 14.3" h	0.9 lb	4.6 cm x 30.0 cm x 36.3 cm	0.41 kg	1
2007907	YELLOW	23G Billboard	1.8" l x 11.8" w x 14.3" h	0.9 lb	4.6 cm x 30.0 cm x 36.3 cm	0.41 kg	1
2007908	GREEN	23G Billboard	1.8" l x 11.8" w x 14.3" h	0.9 lb	4.6 cm x 30.0 cm x 36.3 cm	0.41 kg	1
2007909	BLUE	23G Billboard	1.8" l x 11.8" w x 14.3" h	0.9 lb	4.6 cm x 30.0 cm x 36.3 cm	0.41 kg	1
2007910	BLACK	23G Billboard	1.8" l x 11.8" w x 14.3" h	0.9 lb	4.6 cm x 30.0 cm x 36.3 cm	0.41 kg	1
2007911	DARK GRAY	23G Billboard	1.8" l x 11.8" w x 14.3" h	0.9 lb	4.6 cm x 30.0 cm x 36.3 cm	0.41 kg	1
2007912	BROWN	23G Billboard	1.8" l x 11.8" w x 14.3" h	0.9 lb	4.6 cm x 30.0 cm x 36.3 cm	0.41 kg	1
2171552	BLACK	33G Billboard	19.3" l x 2.1" w x 14.6" h	1.3 lb	49.0 cm x 5.3 cm x 37.0 cm	0.59 kg	1
2171558	BLUE	33G Billboard	19.3" l x 2.1" w x 14.6" h	1.3 lb	49.0 cm x 5.3 cm x 37.0 cm	0.59 kg	1
2171556	GREEN	33G Billboard	19.3" l x 2.1" w x 14.6" h	1.3 lb	49.0 cm x 5.3 cm x 37.0 cm	0.59 kg	1

Slim Jim® Recycling Station – Waste Stream Label Kits

- Slim Jim Recycling Station Pre-Made kits contain 10 waste stream labels

NO.	COLOR	DESCRIPTION	U.S. DIMENSIONS	U.S. SHIP WT/CTN	METRIC DIMENSIONS	METRIC SHIP WT/CTN	PACK
1977787	WHITE	Label Kit: English (United States)	9.5" w x 5.7" h	0.2 lb	24.1 cm x 14.5 cm	0.1 kg	1

STREAMLINE™ STEP-ON CONTAINERS

DECORATIVE REFUSE

CLEANING

MATERIAL HANDLING

WASHROOM

FOODSERVICE

ACCESSORIES
& INDEX



SAFETY AND WELL-BEING

Quiet and controlled lid-closure minimizes noise to enhance guest and patient satisfaction.



DURABILITY

New, redesigned lid hinge improves performance and increases durability.



PRODUCTIVITY

Liner retainer band and cinch easily and securely hold polyliners.



Streamline™ Step-On Containers

Streamline™ containers blend aesthetics and best-in-class durability.

- Commercial-grade pedal tested to 300,000 cycles to ensure life in heavy-use environments*
- Robust lid structure features a rigid arch design to prevent warping
- Stainless steel components resist corrosion for long-lasting, smooth operation
- Liner retainer band and cinch easily and securely holds polyliners
- Increased foot pedal clearance for easier access and operation
- Quiet and controlled lid closure minimizes noise to enhance guest and patient satisfaction
- Self-extinguishing to ensure fire safety and comply with Factory Manual (FM) regulations
- Meets OSHA and OBRA standards for worker and environmental safety



1883552 1883553
90L/24G



1883455 1883456 1883458 1883459 1883460 1883551
15L/4G 30L/8G 50L/13G 68L/18G

NO.	COLOR	DESCRIPTION	U.S. DIMENSIONS	U.S. CAPACITY	U.S. SHIP WT/CTN	METRIC DIMENSIONS	METRIC CAPACITY	METRIC SHIP WT/CTN	PACK
1883455	BEIGE	Resin Front Step	14.8" l x 9.1" w x 15.7" h	4.0 gal	4.70 lb	377 mm x 230 mm x 399 mm	15.0 L	2.1 kg	1
1883554	WHITE	Resin Front Step	14.8" l x 9.1" w x 15.7" h	4.0 gal	4.70 lb	377 mm x 230 mm x 399 mm	15.0 L	2.1 kg	1
1883563	RED	Resin Front Step	14.8" l x 9.1" w x 15.7" h	4.0 gal	4.70 lb	377 mm x 230 mm x 399 mm	15.0 L	2.1 kg	1
1883456	BEIGE	Resin Front Step	16.7" l x 10.6" w x 21.1" h	8.0 gal	6.0 lb	425 mm x 271 mm x 536 mm	30.0 L	2.7 kg	1
1883555	WHITE	Resin Front Step	16.7" l x 10.6" w x 21.1" h	8.0 gal	6.0 lb	425 mm x 271 mm x 536 mm	30.0 L	2.7 kg	1
1883564	RED	Resin Front Step	16.7" l x 10.6" w x 21.1" h	8.0 gal	6.0 lb	425 mm x 271 mm x 536 mm	30.0 L	2.7 kg	1
1883600	GRAY	Resin Front Step	16.7" l x 10.6" w x 21.1" h	8.0 gal	6.0 lb	425 mm x 271 mm x 536 mm	30.0 L	2.7 kg	1
1883609	BLACK	Resin Front Step	16.7" l x 10.6" w x 21.1" h	8.0 gal	6.0 lb	425 mm x 271 mm x 536 mm	30.0 L	2.7 kg	1
1883458	BEIGE	Resin Front Step	17.9" l x 11.5" w x 28.3" h	13.0 gal	8.5 lb	456 mm x 292 mm x 719 mm	50.0 L	3.9 kg	1
1883557	WHITE	Resin Front Step	17.9" l x 11.5" w x 28.3" h	13.0 gal	8.5 lb	456 mm x 292 mm x 719 mm	50.0 L	3.9 kg	1
1883566	RED	Resin Front Step	17.9" l x 11.5" w x 28.3" h	13.0 gal	8.5 lb	456 mm x 292 mm x 719 mm	50.0 L	3.9 kg	1
1883575	YELLOW	Resin Front Step	17.9" l x 11.5" w x 28.3" h	13.0 gal	8.5 lb	456 mm x 292 mm x 719 mm	50.0 L	3.9 kg	1
1883602	GRAY	Resin Front Step	17.9" l x 11.5" w x 28.3" h	13.0 gal	8.5 lb	456 mm x 292 mm x 719 mm	50.0 L	3.9 kg	1
1883611	BLACK	Resin Front Step	17.9" l x 11.5" w x 28.3" h	13.0 gal	8.5 lb	456 mm x 292 mm x 719 mm	50.0 L	3.9 kg	1
1883459	BEIGE	Resin End Step	20.8" l x 13.5" w x 28.4" h	13.0 gal	15.6 lb	527 mm x 343 mm x 721 mm	50.0 L	7.1 kg	1
1883460	BEIGE	Resin Front Step	19.7" l x 12.2" w x 31.6" h	18.0 gal	11.5 lb	500 mm x 311 mm x 803 mm	68.0 L	5.2 kg	1
1883559	WHITE	Resin Front Step	19.7" l x 12.2" w x 31.6" h	18.0 gal	11.5 lb	500 mm x 311 mm x 803 mm	68.0 L	5.2 kg	1
1883568	RED	Resin Front Step	19.7" l x 12.2" w x 31.6" h	18.0 gal	11.5 lb	500 mm x 311 mm x 803 mm	68.0 L	5.2 kg	1
1883604	GRAY	Resin Front Step	19.7" l x 12.2" w x 31.6" h	18.0 gal	11.5 lb	500 mm x 311 mm x 803 mm	68.0 L	5.2 kg	1
1883613	BLACK	Resin Front Step	19.7" l x 12.2" w x 31.6" h	18.0 gal	11.5 lb	500 mm x 311 mm x 803 mm	68.0 L	5.2 kg	1
1883551	BEIGE	Resin End Step	22.1" l x 14.7" w x 30.8" h	18.0 gal	17.1 lb	562 mm x 373 mm x 781 mm	68.0 L	7.8 kg	1
1883552	BEIGE	Resin Front Step	22.4" l x 13.9" w x 32.5" h	24.0 gal	13.4 lb	570 mm x 353 mm x 826 mm	90.0 L	6.1 kg	1
1883561	WHITE	Resin Front Step	22.4" l x 13.9" w x 32.5" h	24.0 gal	13.4 lb	570 mm x 353 mm x 826 mm	90.0 L	6.1 kg	1
1883570	RED	Resin Front Step	22.4" l x 13.9" w x 32.5" h	24.0 gal	13.4 lb	570 mm x 353 mm x 826 mm	90.0 L	6.1 kg	1
1883606	GRAY	Resin Front Step	22.4" l x 13.9" w x 32.5" h	24.0 gal	13.4 lb	570 mm x 353 mm x 826 mm	90.0 L	6.1 kg	1
1883615	BLACK	Resin Front Step	22.4" l x 13.9" w x 32.5" h	24.0 gal	13.4 lb	570 mm x 353 mm x 826 mm	90.0 L	6.1 kg	1
1883579	YELLOW	Resin Front Step	22.4" l x 13.9" w x 32.5" h	24.0 gal	13.4 lb	570 mm x 353 mm x 826 mm	90.0 L	6.1 kg	1
1883553	BEIGE	Resin End Step	25.1" l x 15.9" w x 32.0" h	24.0 gal	21.1 lb	637 mm x 403 mm x 813 mm	90.0 L	9.6 kg	1

*Based on internal testing



Legacy Step-On Containers

The Rubbermaid Commercial Legacy Step-On Container provides sanitary waste management.

- Slow-close, integrated lid damper keeps odors and bacteria from escaping
- Puncture-resistant, all-plastic construction
- Ideal for medical waste containment



FG614500BEIG



FG614500RED



FG614500WHT



2089820

NO.	COLOR	DESCRIPTION	U.S. DIMENSIONS	U.S. CAPACITY	U.S. SHIP WT/CTN	METRIC DIMENSIONS	METRIC CAPACITY	METRIC SHIP WT/CTN	PACK
FG614300	BEIGE, RED, WHITE	8G Legacy Step-On	15.8" l x 16.3" w x 17.1" h	8.0 gal	6.8 lb	40.1 cm x 41.4 cm x 43.4 cm	30.0 L	3.1 kg	1
2089825	BLACK	8G Legacy Step-On	15.8" l x 16.3" w x 17.1" h	8.0 gal	6.8 lb	40.1 cm x 41.4 cm x 43.4 cm	30.0 L	3.1 kg	1
FG614400	BEIGE, RED, WHITE	12G Legacy Step-On	15.0" l x 16.3" w x 23.6" h	12.0 gal	9.0 lb	38.1 cm x 41.4 cm x 59.9 cm	45.0 L	4.1 kg	1
2089820	BLACK	12G Legacy Step-On	15.0" l x 16.3" w x 23.6" h	12.0 gal	9.0 lb	38.1 cm x 41.4 cm x 59.9 cm	45.0 L	4.1 kg	1
FG614500	BEIGE, RED, WHITE	18G Legacy Step-On	14.8" l x 19.8" w x 26.5" h	18.0 gal	12.4 lb	37.6 cm x 50.3 cm x 67.3 cm	68.0 L	5.6 kg	1
FG614600	BEIGE, RED, WHITE	23G Legacy Mobile Step-On	16.5" l x 19.8" w x 32.6" h	23.0 gal	16.2 lb	41.9 cm x 50.3 cm x 82.8 cm	87.0 L	7.3 kg	1
2089821	BLACK	23G Legacy Step-On	16.5" l x 19.8" w x 32.6" h	23.0 gal	16.2 lb	41.9 cm x 50.3 cm x 82.8 cm	87.0 L	7.3 kg	1

When ordering products with **BOLD** color codes, please specify color code after the product number. Refer to the Standard Color Guide at the back of the catalog.

Universal Containers and Tops

Versatile and tough for indoor applications.

Available in round, half-round, and square shapes.

- Durable and crack-resistant, even under tough conditions
- Square containers are perfect for holding large irregular objects making it ideal for use in areas near copiers, printers, and in mail rooms



NO.	COLOR	DESCRIPTION	U.S. DIMENSIONS	U.S. CAPACITY	U.S. SHIP WT/CTN	METRIC DIMENSIONS	METRIC CAPACITY	METRIC SHIP WT/CTN	PACK
FG294700	GRAY	Universal Round Container	15.8" dia x 18.8" h	11.0 gal	15.9 lb	40.0 cm dia x 47.6 cm	42.0 L	7.2 kg	6
FG352000	GRAY, BEIG	Universal Half Round Container	12.0" l x 21.0" w x 28.7" h	21.0 gal	29.5 lb	30.4 cm x 53.3 cm x 72.8 cm	13.4 kg	5.2 kg	4
FG354600	GRAY	Universal Round Container	15.75" dia x 30.1" h	22.0 gal	27.6 lb	40.0 cm dia x 76.5 cm	83.3 L	12.5 kg	4
FG356988	GRAY, BEIG, BLA	Universal Square Container	15.5" l x 16.5" w x 32.9" h	23.0 gal	18.6 lb	39.37 cm x 39.0 cm x 71.0 cm	87.1 L	8.5 kg	3
FG395800	GRAY, BEIG	Universal Square Container (liner for FG917100/FG917300/FG396500)	19.5" sq x 27.6" h	35.0 gal	39.4 lb	49.5 cm sq x 70.2 cm	132.5 L	17.9 kg	4
FG395900	GRAY	Universal Square Container (liner for FG917500/FG917600)	19.5" sq x 34.3" h	50.0 gal	53.3 lb	49.5 cm sq x 87.0 cm	189.3 L	24.1 kg	4
FG356973	BLUE	Universal Square Container	15.5" l x 16.5" w x 32.9" h	23.0 gal	21.2 lb	39.37 cm x 39.0 cm x 71.0 cm	87.1 L	9.6 kg	3
FG395873	BLUE	Universal Square Recycling Container	19.5" sq x 27.6" h	35.0 gal	39.4 lb	49.5 cm sq x 70.2 cm	132.5 L	17.9 kg	4
FG395973	BLUE	Universal Square Recycling Container	19.5" sq x 34.3" h	50.0 gal	53.9 lb	49.5 cm sq x 87.0 cm	189.3 L	24.4 kg	4

¹ Versus 23 gal non-vented Universal container

Lids and Tops

NO.	COLOR	DESCRIPTION	U.S. DIMENSIONS	U.S. SHIP WT/CTN	METRIC DIMENSIONS	METRIC SHIP WT/CTN	PACK
FG279100	DBLUE	Universal Bottle and Can Recycling Top for FG395873, FG395973 Containers	20.1" sq x 6.3" h	11.9 lb	51.1 cm sq x 15.9 cm	5.4 kg	4
FG266400	GRAY, BEIG	Universal Square Swing Top for FG395800, FG395900 Containers	20.13" sq x 6.3" h	22.7 lb	51.1 cm sq x 15.9 cm	10.3 kg	4
FG268988	GRAY, BEIG, BLA	Universal Swing Top for FG356988 Containers	16.0" sq x 4.0" h	13.8 lb	40.6 cm sq x 10.2 cm	6.3 kg	4
FG362000	BLA	Universal Half-Round Lid, with Swing Door for FG352000 Container	21.1" sq x 9.5" h	11.4 lb	53.5 cm sq x 24.1 cm	5.1 kg	4

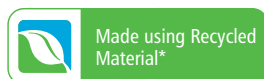

Deskside Waste and Recycling Baskets

Space-efficient, economical, and an easy and effective way to recycle.

- All-plastic construction won't chip, rust, or dent. Rolled rims add strength, and are easy to clean
- Fits under standard-height desk even when swing top is fully extended
- Recycling options available

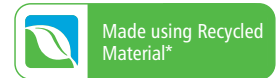

Deskside Wastebaskets

NO.	COLOR	DESCRIPTION	U.S. DIMENSIONS	U.S. CAPACITY	U.S. SHIP WT/CTN	METRIC DIMENSIONS	METRIC CAPACITY	METRIC SHIP WT/CTN	PACK
FG295500	GRAY, BEIG, BLA	Wastebasket, Small	11.4" l x 8.3" w x 12.13" h	13.6 qt	14.3 lb	28.9 cm x 21.0 cm x 30.8 cm	12.9 L	6.5 kg	12
FG295600	GRAY, BEIG, BLA	Wastebasket, Medium	14.4" l x 10.3" w x 15.0" h	28.1 qt	20.7 lb	36.5 cm x 26.0 cm x 38.1 cm	26.6 L	9.4 kg	12
FG295700	GRAY, BEIG, BLA	Wastebasket, Large	11.3" l x 15.3" w x 20.0" h	41.3 qt	27.3 lb	27.9 cm x 39.4 cm x 52.7 cm	12.4 kg	12.4 kg	12
FG295073	BLA	5 qt Side Bin Attachment (Fits 28 qt Wastebasket)	10.6" l x 7.3" w x 11.7" h	5.0 qt	7.2 lb	26.9 cm x 18.5 cm x 29.7 cm	4.7 L	3.4 kg	12
FG306600	BLA	Swing Top for FG295600 Container	15.0" l x 10.9" w x 6.0" h		6.6 lb	38.1 cm x 27.6 cm x 15.2 cm		2.9 kg	6
FG306700	BLA	Swing Top for FG295700 Container	16.0" l x 11.6" w x 7.9" h		8.5 lb	40.6 cm x 29.5 cm x 20.0 cm		3.9 kg	6

Deskside Recycling Containers

NO.	COLOR	DESCRIPTION	U.S. DIMENSIONS	U.S. CAPACITY	U.S. SHIP WT/CTN	METRIC DIMENSIONS	METRIC CAPACITY	METRIC SHIP WT/CTN	PACK
FG295573	BLUE	Deskside Recycling Container, Small with Universal Recycle Symbol	11.4" l x 8.3" w x 12.1" h	13.6 qt	14.3 lb	29.0 cm x 21.0 cm x 30.8 cm	12.9 L	6.5 kg	12
FG295606	GRN	Deskside Recycling Container, Medium with Universal Recycle Symbol	14.5" l x 10.5" w x 15.0" h	28.1 qt	21.7 lb	36.8 cm x 26.7 cm x 38.1 cm	26.6 L	9.8 kg	12
FG295673	BLUE	Deskside Recycling Container, Medium with Universal Recycle Symbol	14.5" l x 10.5" w x 15.0" h	28.1 qt	21.7 lb	36.8 cm x 26.7 cm x 38.1 cm	26.6 L	9.8 kg	12
FG295773	BLUE	Deskside Recycling Container, Large with Universal Recycle Symbol	15.3" l x 11.3" w x 20.0" h	41.3 qt	28.3 lb	38.7 cm x 28.6 cm x 50.8 cm	39.0 L	12.8 kg	12

Concept Collection™

Designer solutions for deskside disposal.

- "No snag" curled rim protects clothing
- Baked-on epoxy finish
- Solid steel base
- Vinyl base ring protects floors



NO.	COLOR	DESCRIPTION	CAPACITY (GAL)	CAPACITY (LITERS)	U.S. DIMENSIONS	U.S. SHIP WT/CTN	METRIC DIMENSIONS	METRIC SHIP WT/CTN	CARTON QUANTITY
FGWMB20	SLV	Concept Collection™ Open-Top Wastebasket	5	18.9	11.5" dia x 14.0" h	10.2 lb	29.2 cm dia x 35.6 cm	4.6 kg	6

When ordering products with **BOLD** color codes, please specify color code after the product number. Refer to the Standard Color Guide at the back of the catalog.

DECORATIVE REFUSE

CLEANING

MATERIAL HANDLING

WASHROOM

FOODSERVICE



FG295600BLA



Profile Containers

Attractive design suits many decors.

- Wall mounting keeps the container out of pedestrian traffic and allows for floor cleaning
- Spring-loaded swing door helps control odor and hides trash from public view
- Comes with complete hardware and instructions for wall mounting
- Factory Mutual (FM) approved for fire safety when wall mounted; ideal for hallways and other uncontrolled public areas
- Slim design limits intrusion into corridors, washrooms, kitchens, and other limited space areas



ADA COMPLIANT



NO.	COLOR	DESCRIPTION	U.S. DIMENSIONS	U.S. CAPACITY	U.S. SHIP WT/CTN	METRIC DIMENSIONS	METRIC CAPACITY	METRIC SHIP WT/CTN	PACK
FG782200	BEIG	Slim Jim® Wall-Mounted Container	19.5" l x 11.9" w x 32.6" h	15.0 gal	11.6 lb	49.5 cm x 30.2 cm x 82.9 cm	56.8 L	5.3 kg	1

Fire-Resistant Wastebaskets

Great for use in areas requiring increased levels of fire protection, such as hospitals, schools, and hotels.

- UL® Classification ensures fire safety
- Textured finish for enhanced aesthetics



CSFM



NO.	COLOR	DESCRIPTION	U.S. DIMENSIONS	U.S. CAPACITY	U.S. SHIP WT/CTN	METRIC DIMENSIONS	METRIC CAPACITY	METRIC SHIP WT/CTN	PACK
FG254100	BLA, BEIG	Fire-Resistant Wastebasket	11.1" l x 8.3" w x 12.3" h	14.0 qt	19.6 lb	28.3 cm x 21.0 cm x 31.1 cm	13.2 L	8.9 kg	6
FG254300	GRAY, BLA, BEIG	Fire-Resistant Wastebasket	14.5" l x 10.5" w x 15.3" h	28.0 qt	30.4 lb	36.8 cm x 26.7 cm x 38.9 cm	26.5 L	13.8 kg	6
FG254400	BEIG	Fire-Resistant Wastebasket	15.0" l x 11.3" w x 20.0" h	40.0 qt	29.6 lb	38.1 cm x 28.6 cm x 50.8 cm	37.9 L	13.4 kg	4

Other Fire-Rated Containers



Profile Wall-Mounted



Step-On Containers



Plaza® Containers



Ranger® Containers



Smoking Management Containers

When ordering products with **BOLD** color codes, please specify color code after the product number. Refer to the Standard Color Guide at the back of the catalog.

Recycling Boxes

The Rubbermaid Commercial Recycling Bin is made of post-consumer recycled resin for commercial recycling use.

- Built-in handles for easier lifting and carrying
- Designed to stack or nest for increased productivity
- Commercial-grade construction to withstand years of indoor and outdoor use



FG571873BLUE

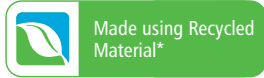

NO.	COLOR	DESCRIPTION	U.S. DIMENSIONS	U.S. CAPACITY	U.S. SHIP WT/CTN	METRIC DIMENSIONS	METRIC CAPACITY	METRIC SHIP WT/CTN	PACK
FG571473	BLUE	14-Gallon Recycling Box	20.8" l x 16.0" w x 14.8" h	14.0 gal	25.2 lb	52.7 cm x 40.6 cm x 37.5 cm	53.0 L	11.4 kg	6
FG571873	BLUE	18-Gallon Recycling Box	25.8" l x 16.5" w x 26.5" h	18.0 gal	30.4 lb	65.4 cm x 41.9 cm x 67.3 cm	68.1 L	13.8 kg	6

Glutton® Recycling Stations

High-capacity, all-in-one centralized solutions for efficient waste sortation.

- The Four-Stream Glutton® Recycling Station is a high-capacity, all-in-one centralized solution for efficient waste separation

Flexible Labeling
Includes separate color-coded symbol and word labels for customizing the Recycling Station based on facility needs.

Multiple Stream Sortation
Use any combination of the restrictive-opening tops to sort up to four separate waste streams. Tops snap securely into lid.

High-Capacity Collection
Improves productivity by reducing the frequency of trips to empty the filled containers. Holds up to 92 gallons of waste.

Permanent Hot-Stamped Logo

Durable Construction
Features traditional Rubbermaid Commercial Products' strength and durability in easy-to-clean, impact-resistant post-consumer plastic.



NO.	COLOR	DESCRIPTION	U.S. DIMENSIONS	U.S. CAPACITY	U.S. SHIP WT/CTN	METRIC DIMENSIONS	METRIC CAPACITY	METRIC SHIP WT/CTN	PACK
1792372	BLUE	Four-Stream Glutton® Recycling Station	53.0" l x 24.0" w x 35.5" h	92.0 gal	67.3 lb	134.6 cm x 61.0 cm x 90.2 cm	348.3 L	30.5 kg	1



Steel Wastebasket Open Tops

Fire-safe, puncture-resistant steel wastebaskets.

- UL® Classification ensures fire safety; the raised bottom prevents heat transfer in case of fire



NO.	COLOR	DESCRIPTION	U.S. DIMENSIONS	U.S. CAPACITY	U.S. SHIP WT/CTN	METRIC DIMENSIONS	METRIC CAPACITY	METRIC SHIP WT/CTN	PACK
FGWB96R	AL	Steel Wastebasket Open Top	21.0" w x 30.0" h	96 qt	37.0 lb	53.3 cm x 76.2 cm	363.4 L	16.8 kg	3

Can Liners

Standard Can Liners

High-quality can liners for a variety of applications.

- Strong "star seal" bottom eliminates gaps along the seal where leaks can occur
- Easily conforms to the shape of the container
- Distributes refuse weight evenly inside the liner

Linear Low-Density Liners

Recommended for sharper objects under tougher transport conditions.

- Excellent resistance to puncture and tearing
- Good load capacity
- Topside dual-dispensing carton allows for top or side dispensing
- Applications include janitorial, housekeeping, everyday use, and schools



Star Seal Bottom

Strong star seal bottom is designed without gussets, where leaks are prone to occur.

FG501188

Materials comply with USDA and FDA regulations for food contact.

NO.	COLOR	U.S. DIMENSIONS	U.S. SIZE	U.S. CAPACITY	U.S. SHIP WT/CTN	METRIC DIMENSIONS	METRIC SIZE	METRIC CAPACITY	METRIC SHIP WT/CTN	U.S./METRIC GAUGE	PACK
FG501188	GRAY	48.0" l x 39.5" w	79.0" cir	55 gal	27.3 lb	121.9 cm x 100.3 cm	200.6 cm	208.2 L	12.2 kg	2.0 mil/50 µm	1/100 pcs
FG500888	CLEAR	44.0" l x 37.0" w	79.0" cir	45 - 55 gal	27.3 lb	111.8 cm x 94.0 cm	200.6 cm	166.1 - 208.2 L	12.4 kg	2.0 mil/50 µm	1/100 pcs

When ordering products with **BOLD** color codes, please specify color code after the product number. Refer to the Standard Color Guide at the back of the catalog.

Utility Refuse Waste Stream Label Kits*

The Waste Stream Label Kits contain ten intuitive waste stream decals, ensuring waste sortation accuracy.

Version C (1977787) Fits 32 and 44 Gal BRUTE® Containers, and the Slim Jim® Recycling Station™

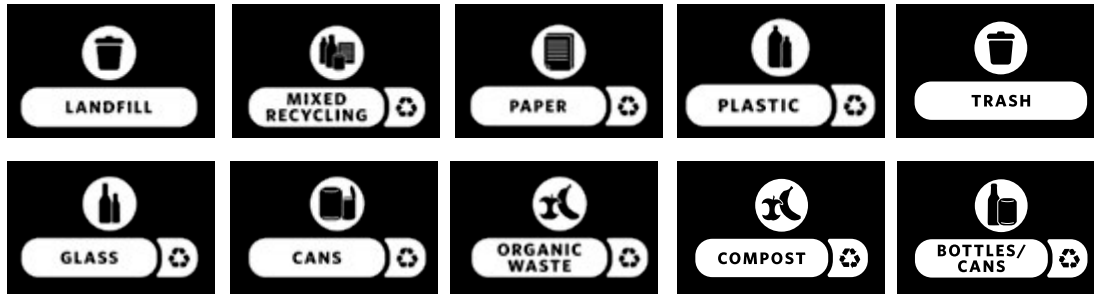

* Sized to fit correct container.

** Labels are clear and will match the color of the container on which they're placed.

NO.	DESCRIPTION	U.S. DIMENSIONS	PACK
1977787	Recycling Station Label Kit Version C fits 32 and 44 Gal BRUTE® Containers, and the Slim Jim Recycling Station	9.5" w x 5.7" h	1

Labels have clear substrate to allow color of container to show through.

DECORATIVE REFUSE

CLEANING

MATERIAL HANDLING

WASHROOM

FOODSERVICE

ACCESSORIES
& INDEX



FG264360BLA / FG264360BLUE / 1977787 / FG264600BLA





DECORATIVE REFUSE



2185041



2172843

DECORATIVE REFUSE

INDOOR CONTAINERS

Configure™	42
Sustain	45
Enhance™	47
Silhouettes	49
Refine	51
Elevate™	51
Defenders®	52
Impressions™	53
Half Rounds	53
Crowne	54
Atrium®	54
Metallic Series	55
Eclipse	55
Classics	56
Marshal® Classic	56

OUTDOOR CONTAINERS

Resist®	59
Outdoor Recycling Station Guide	61
Tailor™	62
Landmark Series®	62
Decorative Panels	63
Ranger®	65
Landmark Series® Gas Station/Store Front Containers	66
Plaza®	66
Glutton®	67
Americana Series™	67

SMOKING MANAGEMENT

Smokers' Pole	68
GroundsKeeper® Receptacles	68
Aladdin Smokers' Station®	69
Smoking Station Sand	69
Metropolitan Smokers' Station	70
Smokers' Station® Wall Mount	70
Infinity™ Smoking Management	71

Configure™

Configure™ decorative refuse containers have a modern appearance that will fit seamlessly into any commercial environment. Mix and match waste stream labels, capacities, and signage to meet facility-specific waste and recycling needs.

- Magnetic connections allow containers to attach to one another and stay neatly arranged in the order that best fits the space
- Easy-access front door and handle allow for ergonomic emptying of waste
- Internal door hinge prevents unsightly wall damage and helps maintain a neat, clean appearance in commercial spaces



ADA COMPLIANT



1961622/1961590

NO.	FRONT COLOR	SIDE/BACK COLOR	DESCRIPTION	GALLONS	LENGTH	WIDTH	HEIGHT
1961614	GRAY STENNI GLOSS	TEXTURED BLACK	15G with Landfill Label	15.0	14.4"	19.5"	38.4"
1961615	GRAY STENNI GLOSS	TEXTURED BLACK	15G with Mixed Recycling Label	15.0	14.4"	19.5"	38.4"
1961616	GRAY STENNI GLOSS	TEXTURED BLACK	15G with Paper Label	15.0	14.4"	19.5"	38.4"
1961619	GRAY STENNI GLOSS	TEXTURED BLACK	15G with Cans Label	15.0	14.4"	19.5"	38.4"
1961620	GRAY STENNI GLOSS	TEXTURED BLACK	15G with Compost Label	15.0	14.4"	19.5"	38.4"
1961621	GRAY STENNI GLOSS	TEXTURED BLACK	23G with Landfill Label	23.0	19.2"	19.5"	38.4"
1961622	GRAY STENNI GLOSS	TEXTURED BLACK	23G with Mixed Recycling Label	23.0	19.2"	19.5"	38.4"
1961623	GRAY STENNI GLOSS	TEXTURED BLACK	23G with Paper Label	23.0	19.2"	19.5"	38.4"
1961626	GRAY STENNI GLOSS	TEXTURED BLACK	23G with Cans Label	23.0	19.2"	19.5"	38.4"
1961627	GRAY STENNI GLOSS	TEXTURED BLACK	23G with Compost Label	23.0	19.2"	19.5"	38.4"
1961628	GRAY STENNI GLOSS	TEXTURED BLACK	33G with Landfill Label	33.0	24.0"	19.5"	38.4"
1961629	GRAY STENNI GLOSS	TEXTURED BLACK	33G with Mixed Recycling Label	33.0	24.0"	19.5"	38.4"
1961630	GRAY STENNI GLOSS	TEXTURED BLACK	33G with Paper Label	33.0	24.0"	19.5"	38.4"
1961505	GRAY STENNI GLOSS	TEXTURED BLACK	33G with Cans Label	33.0	24.0"	19.5"	38.4"
1961506	GRAY STENNI GLOSS	TEXTURED BLACK	33G with Compost Label	33.0	24.0"	19.5"	38.4"
1961507	GRAY STENNI GLOSS	TEXTURED BLACK	45G with Landfill Label	45.0	28.8"	19.5"	38.4"
1961508	GRAY STENNI GLOSS	TEXTURED BLACK	45G with Mixed Recycling Label	45.0	28.8"	19.5"	38.4"
1961509	GRAY STENNI GLOSS	TEXTURED BLACK	45G with Paper Label	45.0	28.8"	19.5"	38.4"
1961682	GRAY STENNI GLOSS	TEXTURED BLACK	45G with Cans Label	45.0	28.8"	19.5"	38.4"
1961683	GRAY STENNI GLOSS	TEXTURED BLACK	45G with Compost Label	45.0	28.8"	19.5"	38.4"

When ordering products with **BOLD** color codes, please specify color code after the product number. Refer to the Standard Color Guide at the back of the catalog.

Additional Signage

NO.	FRONT COLOR	DESCRIPTION	COMPATIBLE WITH THE FOLLOWING CONFIGURE SIZES	LENGTH	WIDTH	HEIGHT
1961572	BLACK	15G with Landfill Label	15.0 GAL	14.0"	1.8"	8.5"
1961588	BLUE	15G with Mixed Recycling Label	15.0 GAL	14.0"	1.8"	8.5"
1961589	BLUE	15G with Paper Label	15.0 GAL	14.0"	1.8"	8.5"
1961596	YELLOW	15G with Cans Label	15.0 GAL	14.0"	1.8"	8.5"
1961580	GREEN	15G with Compost Label	15.0 GAL	14.0"	1.8"	8.5"
1961573	BLACK	23G with Landfill Label	23.0 GAL	18.8"	1.8"	8.5"
1961590	BLUE	23G with Mixed Recycling Label	23.0 GAL	18.8"	1.8"	8.5"
1961591	BLUE	23G with Paper Label	23.0 GAL	18.8"	1.8"	8.5"
1961597	YELLOW	23G with Cans Label	23.0 GAL	18.8"	1.8"	8.5"
1961581	GREEN	23G with Compost Label	23.0 GAL	18.8"	1.8"	8.5"
1961574	BLACK	33G with Landfill Label	33.0 GAL	23.6"	1.8"	8.5"
1961592	BLUE	33G with Mixed Recycling Label	33.0 GAL	23.6"	1.8"	8.5"
1961593	BLUE	33G with Paper Label	33.0 GAL	23.6"	1.8"	8.5"
1961598	YELLOW	33G with Cans Label	33.0 GAL	23.6"	1.8"	8.5"
1961582	GREEN	33G with Compost Label	33.0 GAL	23.6"	1.8"	8.5"
1961575	BLACK	45G with Landfill Label	45.0 GAL	28.4"	1.8"	8.5"
1961594	BLUE	45G with Mixed Recycling Label	45.0 GAL	28.4"	1.8"	8.5"
1961595	BLUE	45G with Paper Label	45.0 GAL	28.4"	1.8"	8.5"
1961599	YELLOW	45G with Cans Label	45.0 GAL	28.4"	1.8"	8.5"
1961583	GREEN	45G with Compost Label	45.0 GAL	28.4"	1.8"	8.5"



1961507/1961575/1961508/1961594





2078988 / 2078980 / 2078992

When ordering products with **BOLD** color codes, please specify color code after the product number. Refer to the Standard Color Guide at the back of the catalog.

Sustain

Improve recycling effectiveness with the Sustain recycling station, a decorative and adaptable recycling solution designed to meet any facility's needs. The modular system allows the station to be customized to and grow with each recycling program.

- A variety of colored recycling lids and designated lid openings clearly indicate streams to users
- Colored lids and labels makes sorting recycling easier for both patrons and staffs
- Lids nest neatly with lids of same size for convenient placement during liner changes
- Adjustable, easy-glide feet allow the container to be moved efficiently and ensure a level placement



2078988

2078992

2078980

NO.	COLOR	DESCRIPTION	GALLONS	LENGTH	WIDTH	HEIGHT
2078967	BLACK/CHARCOAL	Sustain Landfill	15.0	12.8"	17.9"	36.1"
2078994	BLACK/BLUE	Sustain Mixed Recycling	15.0	12.8"	17.9"	36.1"
2078991	BLACK/GREEN	Sustain Compost	15.0	12.8"	17.9"	36.1"
2078988	BLACK/CHARCOAL	Sustain Landfill	23.0	16.8"	17.9"	36.1"
2078980	BLACK/BLUE	Sustain Mixed Recycling	23.0	16.8"	17.9"	36.1"
2078992	BLACK/GREEN	Sustain Compost	23.0	16.8"	17.9"	36.1"



2078994 /2078967



2172842

When ordering products with **BOLD** color codes, please specify color code after the product number. Refer to the Standard Color Guide at the back of the catalog.

Enhance™

Enhance™ is a premium waste system that is purpose built for high-end aesthetics.

- Floating lid gives the appearance of lightness and enables a pinch-free close
- The flare on the receptacle rim provides visual appeal and allows room for user's hand to easily grip the plastic liner during removal
- Contrasting frame and panels create visual interest and complement a property's upscale look



2172845



2172846



2172851



2172843



2172849



2172841



2172850



2172848

NO.	COLOR	DESCRIPTION	GALLONS	LENGTH	WIDTH	HEIGHT
2172845	GRAY	Half Round Single Stream	11.5	21.9"	11.1"	30.9"
2172846	GRAY	Half Round Dual Stream	11.5	21.9"	11.1"	30.9"
2172851	GRAY	Pill Single Stream	13.0	21.5"	11.5"	30.6"
2172843	GRAY	Pill Dual Stream	2 x 23.0	41.6"	21.7"	31.8"
2172849	GRAY	Round Single Stream	23.0	20.6"	20.6"	31.2"
2172850	BLACK	Round Single Stream	23.0	20.6"	20.6"	31.2"
2172841	GRAY	Round Dual Stream	23.0	20.6"	20.6"	31.2"
2172844	BLACK	Round Dual Stream	23.0	20.6"	20.6"	31.2"
2172852	GRAY	Round Single Stream	33.0	20.6"	20.6"	37.4"
2172842	BLACK	Round Single Stream	33.0	20.6"	20.6"	37.4"
2172847	GRAY	Round Dual Stream	33.0	20.6"	20.6"	37.4"
2172848	BLACK	Round Dual Stream	33.0	20.6"	20.6"	37.4"

UTILITY REFUSE
AND RECYCLING

DECORATIVE REFUSE

CLEANING

MATERIAL HANDLING

WASHROOM

FOODSERVICE

ACCESSORIES
& INDEX



FGSR18EPLSM

When ordering products with **BOLD** color codes, please specify color code after the product number. Refer to the Standard Color Guide at the back of the catalog.

Silhouettes

The sleek Silhouettes decorative refuse container has a contemporary graphic pattern designed to seamlessly and beautifully blend with indoor modern environments.

- Hinged lid for easy waste removal
- Optional waste stream decals and lid shape openings available for easier recycling compliance
- Leg levelers provide stability on uneven surfaces
- Includes rigid plastic liner



ADA COMPLIANT



Square Dual Stream
2182675

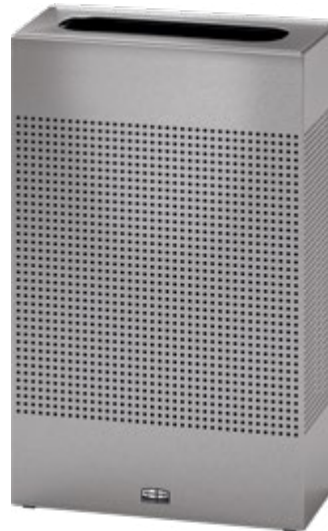

Large Rectangle
FGSR18EPLSM

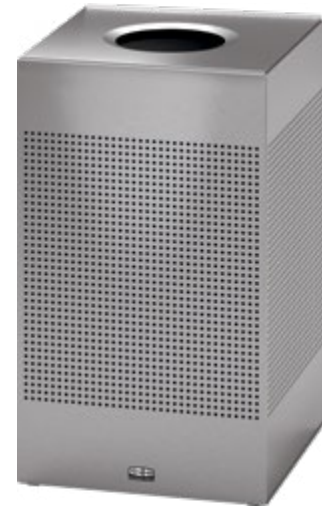

Square Open Top
FGSC18EPLSM

NO.	COLOR	DESCRIPTION	GALLONS	LENGTH	WIDTH	HEIGHT
FGSC14EPLSM	STARDUST SILVER METALLIC	Square Open Top 60L/16G	16.0	14.8"	14.8"	30.4"
FGSC14EPLTBK	TEXTURED BLACK	Square Open Top 60L/16G	16.0	14.8"	14.8"	30.4"
FGSC18EPLSM	STARDUST SILVER METALLIC	Square Open Top 75L/20G	20.0	18.4"	18.4"	30.4"
FGSC18SSPL	STAINLESS STEEL	Square Open Top 75L/20G	20.0	18.4"	18.4"	30.4"
FGSC18EPLTBK	TEXTURED BLACK	Square Open Top 75L/20G	20.0	18.4"	18.4"	30.4"
FGSR18EPLSM	STARDUST SILVER METALLIC	Large Rectangle 85L/22.5G	22.5	24.0"	12.0"	30.4"
FGSR18SSPL	STAINLESS STEEL	Large Rectangle 85L/22.5G	22.5	24.0"	12.0"	30.4"
FGSR18EPLTBK	TEXTURED BLACK	Large Rectangle 85L/22.5G	22.5	24.0"	12.0"	30.4"
FGSC22EPLSM	STARDUST SILVER METALLIC	Square Open Top 151L/40G	40.0	21.7"	21.7"	30.4"
FGSC22EPLTBK	TEXTURED BLACK	Square Open Top 151L/40G	40.0	21.7"	21.7"	30.4"
2182675	STARDUST SILVER METALLIC	Square Dual Stream	34G	21.7"	21.7"	30.4"



2147582

When ordering products with **BOLD** color codes, please specify color code after the product number. Refer to the Standard Color Guide at the back of the catalog.

Refine

Designed to fit seamlessly into any commercial space for a discreet look that enhances the overall environment. The commercial-grade material ensures the containers will withstand the rigors of everyday use.

- Lid lifts off for easy access to liner bag
- Integrated liner cinch
- Fingerprint-resistant stainless steel
- Durable handles improve grip and ergonomics



2147584



2147550



2147581

NO.	COLOR	DESCRIPTION	GALLONS	LENGTH	WIDTH	HEIGHT
2147583	STAINLESS STEEL	Refine Round Top	16.0	15.9"	15.9"	26.3"
2147584	STAINLESS STEEL	Refine Round Top	23.0	17.7"	17.7"	29.6"
2147550	STAINLESS STEEL	Refine Half Round	16.0	18.2"	12.4"	29.5"
2147582	STAINLESS STEEL	Refine Half Round	21.0	19.7"	13.7"	29.5"
2147581	STAINLESS STEEL	Refine Slim	15.0	18.2"	11.3"	25.6"

Elevate™

The three-sided metal Elevate™ cover/container transforms Slim Jim® containers into streamlined, decorative containers, or can be used as a standalone container against a wall.

- Simple, intuitive design enables easy assembly in under 5 minutes with minimal tools required
- Three-sided design allows container to effortlessly slide out, and retainer bands offer more efficient liner changes
- Resin rims securely snap onto the container to provide durability and stability, even in the toughest environments
- Slim Jim® sold separately



NO.	COLOR	DESCRIPTION	GALLONS	LENGTH	WIDTH	HEIGHT	PACK SIZE
2136963	PEARL DARK GRAY	Elevate™ Landfill 23G	23.0	25.1"	12.8"	31.5"	1

Defenders®

The Defenders® decorative refuse container is an ideal indoor waste receptacle for hospitals, doctors' offices and other healthcare facilities. The step-on foot pedal enables hands-free operation, optimizing sanitary efforts.

- Restraint mechanism protects walls
- Smooth surfaces are easy to clean
- Leak-proof rigid plastic liner contains liquids and keeps the surrounding area cleaner



CSFM



OSHA



FGST12EPLRD

NO.	COLOR	DESCRIPTION	GALLONS	LENGTH	WIDTH	HEIGHT
FGST7EPLRD	RED GLOSS	Square Step Can 26L/4G	4.0	13.0"	14.2"	17.7"
FGST12EPLWH	SKY WHITE GLOSS	Square Step Can 45L/6.5G	6.5	13.0"	14.2"	23.7"
FGST12EPLRD	RED GLOSS	Square Step Can 45L/6.5G	6.5	13.0"	14.2"	23.7"
FGST12SSPL	STAINLESS STEEL	Square Step Can 45L/6.5G	6.5	13.0"	14.2"	23.7"
FGST24EPLWH	SKY WHITE GLOSS	Square Step Can 90L/13G	13.0	15.6"	16.5"	30.6"
FGST24SSPL	STAINLESS STEEL	Square Step Can 90L/13G	13.0	15.6"	16.5"	30.6"
FGST24EPLRD	RED GLOSS	Square Step Can 90L/13G	13.0	15.6"	16.5"	30.6"
FGST40EPLWH	SKY WHITE GLOSS	Square Step Can 151L/25G	25.0	18.9"	21.0"	30.8"
FGST40SSPL	STAINLESS STEEL	Square Step Can 151L/25G	25.0	18.9"	21.0"	30.8"

CLEANING

MATERIAL HANDLING

WASHROOM

FOODSERVICE

ACCESSORIES
& INDEX

FGST24EPLWH

When ordering products with **BOLD** color codes, please specify color code after the product number. Refer to the Standard Color Guide at the back of the catalog.

Impressions™

Step-On containers are the smart choice for large-capacity, hands-free waste collection. Attractive design is suitable for front- and back-of-house applications.

- Includes rigid plastic liner
- Fingerprint-resistant stainless steel



OSHA OBRA



NO.	COLOR	DESCRIPTION	GALLONS	LENGTH	WIDTH	HEIGHT
1901982	STAINLESS STEEL	Stainless Steel Front Step	4.0	15.6"	11.9"	15.7"
1901985	STAINLESS STEEL	Stainless Steel Front Step	8.0	16.8"	12.8"	21.9"
1901992	STAINLESS STEEL	Stainless Steel Front Step	13.0	18.1"	13.7"	28.7"
1901993	STAINLESS STEEL	Stainless Steel End Step	13.0	22.7"	11.6"	28.9"
1901999	STAINLESS STEEL	Stainless Steel Front Step	24.0	21.8"	16.2"	31.8"

Half Rounds

The Half Rounds Series decorative refuse container fits flush against walls to conserve space. The sleek and functional design of this receptacle blends seamlessly with upscale and modern indoor facilities.

- Bottom rim is designed to protect floors
- Includes rigid plastic liner



ADA COMPLIANT



NO.	COLOR	DESCRIPTION	GALLONS	LENGTH	WIDTH	HEIGHT
FGSO8SSSPL	STAINLESS STEEL	Flat Top	9.0	8.8"	17.6"	32.5"
FGSO820PLBK	BLACK GLOSS W/ CHROME TRIM	Flat Top	9.0	8.8"	17.6"	32.5"
FGSH12SSPL	STAINLESS STEEL	Open Top Perforated Panels	12.0	8.8"	17.6"	32.4"
FGSH12EPLSM	STARDUST SILVER METALLIC	Open Top Perforated Panels	12.0	8.8"	17.6"	32.4"
FGSH12EPLTBK	TEXTURED BLACK	Open Top Perforated Panels	12.0	8.8"	17.6"	32.4"
FGSO12SSSPL	STAINLESS STEEL	Open Top Solid Panels	12.0	8.8"	17.6"	32.5"
FGSO1220PLBK	BLACK GLOSS W/ CHROME TRIM	Open Top Solid Panels	12.0	8.8"	17.6"	32.5"



Crowne

The Crowne decorative refuse indoor container has an attractive contemporary design with a curved open top that prevents objects from being placed on top of the can, keeping a neater overall appearance.

- Base of receptacle is designed to protect floors
- Receptacles have a large opening for easy waste disposal
- Includes rigid plastic liner



ADA COMPLIANT



FGAOT30SAPL

NO.	COLOR	DESCRIPTION	GALLONS	LENGTH	WIDTH	HEIGHT
FGAOT30SAPL	SATIN ALUMINUM	Open Top 113L/30G	30.0	20.0"	20.0"	34.5"

Atrium®

Durable and corrosion-resistant, the Atrium® decorative refuse indoor container has a clean, classic look. Exterior surfaces are highly polished for a smooth and blemish-free appearance.

- Designed to conceal and securely hold liner bags



ADA COMPLIANT



FGAOT35SAPL



FGAOT62SAPL

NO.	COLOR	DESCRIPTION	GALLONS	LINER TYPE	LENGTH	WIDTH	HEIGHT
FGAOT35SAPL	SATIN ALUMINUM	Open Top 79L/21G	21.0	Plastic	18.0"	18.0"	32.0"
FGAOT35SA	SATIN ALUMINUM	Open Top 132L/35G	35.0	-	18.0"	18.0"	32.0"
FGAOT62SAPL	SATIN ALUMINUM	Open Top 208L/55G	55.0	Plastic	24.0"	24.0"	35.0"

Metallic Series

The Metallic Series decorative refuse container has a sleek design that blends nicely with upscale interiors.

- A protective vinyl trim is applied to the disposal opening of the Flat Top and Ash/Trash containers to help withstand the rigors of everyday use
- Bottom rim designed to protect floors
- Flat top style has a large opening for easy waste disposal
- Includes galvanized liner



ADA COMPLIANT



FGS016SSSGL

NO.	COLOR	DESCRIPTION	GALLONS	LENGTH	WIDTH	HEIGHT
FGS016SSSGL	SATIN STAINLESS STEEL	Flat Top 45L/12G	12.0	15.0"	15.0"	28.0"

Eclipse

With its exclusive curved top, the Eclipse decorative refuse container offers a stylish addition to any contemporary décor.

- Designed with a curved top to prevent the placement of objects on the top edge
- Includes rigid plastic liner



FGR2030SSPL



FGR2030SSPL

NO.	COLOR	DESCRIPTION	GALLONS	LENGTH	WIDTH	HEIGHT
FGR2030SSPL	STAINLESS STEEL	Eclipse Open Top Metal Refuse	30.0	20.0"	20.0"	33.5"
FGR2030EPLBK	BLACK GLOSS	Eclipse Open Top Metal Refuse	30.0	20.0"	20.0"	33.5"

Classics

The heavy-duty Classics decorative refuse container has a perforated steel design for a clean and modern appearance. This container is a smart choice for high-traffic areas and can be used both outdoors and indoors.

- Retainer bands discreetly hold liner bags in place and out of sight
- Lid is fastened to receptacle with a cable, making it easier to collect waste
- Heavy-gauge steel for lasting durability in high-traffic areas
- Includes rigid plastic liner



ADA COMPLIANT



FGS55STSSPL



FGS3ETBKPL

NO.	COLOR	DESCRIPTION	GALLONS	LENGTH	WIDTH	HEIGHT
FGS3ETBKPL	TEXTURED BLACK	Open Top 94L/25G	25.0	18.3"	18.3"	35.0"
FGS55ETBKPL	TEXTURED BLACK	Open Top 193L/51G	51.0	24.4"	24.4"	36.3"
FGS55STSSPL	STAINLESS STEEL	Open Top 193L/51G	51.0	24.4"	24.4"	36.3"

Marshal® Classic

Practical good looks combined with fire safety.

- Includes retainer hardware for securing and concealing can liners
- Textured finish minimizes the appearance of surface scratches



ADA COMPLIANT



FG816088BEIG



FG817088BLA

NO.	COLOR	DESCRIPTION	GALLONS	LENGTH	WIDTH	HEIGHT
FG816088*	BEIG, BLA, BRN	Marshal® Classic Container	15.0	15.4"	15.4"	36.5"
FG817088*	BEIG, BLA, BRN	Marshal® Classic Container	25.0	18.0"	18.0"	42.0"
FG355000	GRAY	Rigid Liner for FG816088 Container	12.1	12.0"	12.0"	27.3"
FG355200	GRAY	Rigid Liner with Rim for FG817088 Container	22.0	14.5"	14.5"	30.1"

*FM-Approved

*Rigid liner not included.

When ordering products with **BOLD** color codes, please specify color code after the product number. Refer to the Standard Color Guide at the back of the catalog.

DECORATIVE REFUSE OUTDOOR CONTAINERS



CAUTION
RESTROOMS
OPERATION AREA
TO RECYCLE
PLASTIC AND
PAPER ONLY
NO OTHER WASTE

CAUTION
IN CASE OF FIRE
EVACUATE AND
EXIT BY STAIRS,
SEE EXIT SIGNS

OUTDOOR CONTAINERS

Resist™	59
Outdoor Recycling Station Guide	61
Tailor™	62
Landmark Series®	62
Decorative Panels	63
Ranger®	65
Landmark Series® Gas Station/Store Front Containers	66
Plaza®	66
Glutton®	67
Americana Series™	67

2182672 / 2182610





2184980



2185042



2184979

Resist®

The Resist® container is built to withstand the toughest outdoor environments with durability features including dent, graffiti, stain, and UV resistance.

- Fan design is dent resistant
- Special coating helps defend surface from graffiti and everyday stains by enabling easy removal of common stains
- UV-resistant coating helps keep the container looking better longer
- Permanent rainhood helps prevent unwanted environmental debris from entering the receptacle



2185041



2184980

NO.	COLOR	DESCRIPTION	GALLONS	LENGTH	WIDTH	HEIGHT
2185041	BLACK	Resist® 33G Single Stream	33.0	27.2"	27.2"	49.9"
2184979	BLACK	Resist® 45G Single Stream	45.0	29.2"	29.2"	49.9"
2184980	BLACK	Resist® 46G Dual Stream	2 x 23.0	48.2"	24.3"	43.6"
2185042	BLACK	Resist® 66G Dual Stream	2 x 33.0	48.2"	24.3"	49.6"

Pair the Tailor™ Frames and Landmark Series® Containers with a variety of Decorative Resin or Metal Panels to create a modular and interchangeable system that can be customized and grow with each recycling program's needs.



2182678 / 2182674 / 2182679

When ordering products with **BOLD** color codes, please specify color code after the product number. Refer to the Standard Color Guide at the back of the catalog.

OUTDOOR RECYCLING STATION GUIDE

Step 1

SELECT FRAME

Tailor™
(Metal Frame & Liner)

Landmark Series®
(Resin Frame & Liner)



41 Gal

51 Gal



35 Gal

50 Gal

Step 2

SELECT PANELS FOR WASTE STREAM NEEDS

Medium (Compatible with
41 Gal Tailor™ & 35 Gal
Landmark Series®)

Large (Compatible with
51 Gal Tailor™ & 50 Gal
Landmark Series®)



Step 3

INSTALL PANELS INTO FRAME

Tailor™

Landmark Series®



Tailor™

The durable Tailor™ container is designed with form and function in mind to enhance overall environmental aesthetics while contributing to waste diversion goals.

- Heavy-gauge steel and powder coated finish stand up to heavy use and harsh weather conditions
- Tailor™ is compatible with RCP Decorative Panels to create a modular and interchangeable system that can be customized to and grow with each recycling program's needs
- Hinged lid enables easy waste removal
- Adjustable leg levelers create stability on uneven surfaces



2182672



2182678

NO.	COLOR	DESCRIPTION	GALLONS	LENGTH	WIDTH	HEIGHT
2182672	BLACK	Tailor™ 41G Metal Frame	41.0	25.2"	25.2"	44.6"
2182678	BLACK	Tailor™ 51G Metal Frame	51.0	25.2"	25.2"	50.6"

Landmark Series®

High-volume refuse collection and smoking management for indoor and outdoor areas, including building entrances, lobbies, and malls.

- Tops are hinged and include a stay-open strap for easy access to rigid liner
- Landmark Series® is compatible with RCP Decorative Panels to create a modular and interchangeable system that can be customized to and grow with each recycling program's needs
- Ash/Trash models include metal sand pan and large refuse openings



FG397000BLA / 2182610



FG397500SBLE / FG400400ROCK

NO.	COLOR	DESCRIPTION	GALLONS	LENGTH	WIDTH	HEIGHT
FG397000	SBLE, BLA	Landmark Series® Classic Container, Dome Top Frame with FG395800 Rigid Liner	35.0	26.0"	26.0"	40.0"
FG397001	SBLE, BLA	Landmark Series® Classic Container, Dome Top with Ash Tray, Frame and FG395800 Rigid Liner	35.0	26.0"	26.0"	40.0"
FG397500	SBLE, BLA	Landmark Series® Classic Container, Dome Top Frame with FG395900 Rigid Liner	50.0	26.0"	26.0"	46.5"
FG397501	BLA	Landmark Series® Classic Container, Dome Top with Ash Tray, Frame and FG395900 Rigid Liner	50.0	26.0"	26.0"	46.5"

Decorative Panels

Color coded panels make sorting recycling easier for both patrons and staff

- Decorative metal panels provide a sleek look for an updated, modern appearance
- Modular system allows compatible containers to be customized to and grow with each recycling program's needs
- Panels slide seamlessly into the frame of compatible containers, making it easy to switch out panels as recycling regulations and facility needs change
- In order to get 4 panels, order 4 for the rock panel and 1 for all other panels



2182671



2182677



2182673

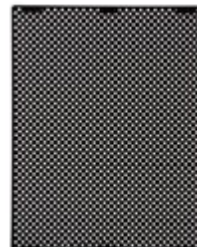

2182610



FG400300ROCK

NO.	COLOR	DESCRIPTION	COMPATIBLE WITH	LENGTH	WIDTH	HEIGHT
2182671	BLACK	Medium Landfill Panel Resin Panel	35G Landmark, 41G Tailor™	20.7"	0.5"	28.0"
2182677	BLUE	Medium Mixed Recycling Resin Panel	35G Landmark, 41G Tailor™	20.7"	0.5"	28.0"
2182673	GREEN	Medium Compost Resin Panel	35G Landmark, 41G Tailor™	20.7"	0.5"	28.0"
2182610	BLACK	Medium Decorative Metal Panel	35G Landmark, 41G Tailor™	20.7"	0.5"	28.0"
FG400300	ROCK	Medium Rock Panel	35G Landmark, 41G Tailor™	20.1"	0.2"	28.0"
2182679	BLACK	Large Landfill Resin Panel	50G Landmark, 51G Tailor™	20.7"	0.5"	34.3"
2182674	BLUE	Large Mixed Recycling Resin Panel	50G Landmark, 51G Tailor™	20.7"	0.5"	34.3"
2182676	BLACK	Large Decorative Metal Panel	50G Landmark, 51G Tailor™	20.7"	0.5"	34.3"
FG400400	ROCK	Large Rock Panel	50G Landmark, 51G Tailor™	20.8"	0.4"	34.5"



FG397000BLA / 2182673 / 2182677 / 2182671



FG843088BEIG

When ordering products with **BOLD** color codes, please specify color code after the product number. Refer to the Standard Color Guide at the back of the catalog.

Ranger®

Ranger® waste containers feature Rubbermaid's famous durability and easy-to-service design for outdoor use.

- Designed for stadiums, parks, shopping malls, and other high-traffic areas
- Permanently attached hinged lid for easy emptying
- 45-gallon containers come with a decorative base that can be swapped out for the weighted base (FG917700BLA). 35-gallon containers do not come with a decorative rim and do not have a weighted base option



FG843088BEIG

FG917188BLA

LID OPTIONS

Ranger® 45-gallon containers are available in two styles:

2 HINGED DOORS for waste concealment and odor control.

4 OPENINGS for easier access in high-traffic areas.

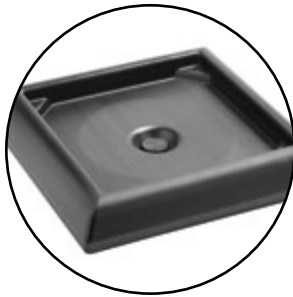

WEIGHTED BASE OPTION

Optional Weighted Base (FG917700) is secured with screws and is available for 45-Gallon Ranger® container for added stability. To be filled with sand or water by customer.



ENHANCED DURABILITY

Ranger® lids feature integrated, durable hinges that keep the lid securely attached to the container during emptying.



BETTER LINER RETENTION

Metal retainers keep can liners securely in place and eliminate knot tying.

NO.	COLOR	DESCRIPTION	GALLONS	LENGTH	WIDTH	HEIGHT
FG843088 ¹	BLA, BEIG	35-Gallon Ranger® Container with 2 Doors	35.0	21.5"	21.5"	41.0"
FG917188 ¹	BLA, BEIG	45-Gallon Ranger® Container with 2 Doors	45.0	24.9"	24.9"	41.5"
FG917388 ⁴	BLA, BEIG	45-Gallon Ranger® Container with 4 Openings	45.0	24.9"	24.9"	41.5"
FG917700 ¹	BLA	Weighted Base Accessory for 45-Gallon Ranger® Containers	N/A	24.5"	24.5"	6.0"
FG356600	GRAY	Rigid Liner for FG843088	24.5	16.3"	16.3"	28.5"
FG356700	GRAY	Rigid Liner for FG917188/FG917388	35.5	18.3"	18.3"	29.1"
FG395800	GRAY, BEIG	Universal Square Container (liner for FG917188/FG917388)	35.0	19.5"	19.5"	27.6"

⁴Provides hands-free use.

¹FM-Approved



Landmark Series® Gas Station/Store Front Containers

Style combined with functionality helps make gas islands and store fronts appealing and efficient for outdoor use.

- Landmark Series® models integrate waste management and window washing
- Insert personal messages and advertising with panel frame models (FG9W0200)
- Standard bolt-down base for stability



ADA COMPLIANT



FG9W0200BLA



FG9W0200BLA / FG9W0400BLA

Display your own custom insert to promote special messages right at the pump.

Landmark Series® Gas Station/Store Front Containers

NO.	COLOR	DESCRIPTION	GALLONS	LENGTH	WIDTH	HEIGHT
FG9W0200	BLA	Landmark Series® Funnel Top with Panel Frame and FG395800 Rigid Liner	35.0	24.0"	24.0"	31.0"

Landmark Series® Accessory (Sold Separately)

NO.	COLOR	DESCRIPTION	GALLONS	LENGTH	WIDTH	HEIGHT
FG9W0400	BLA	Window Wash Kit for FG9W0200, FG9W0300 Containers	N/A	6.3"	16.3"	30.0"

Plaza®

Contemporary styling with side opening door for "no lift" unloading.

- The 35-gallon size is ideal for tight spaces and ships fully assembled
- Spring-loaded swing doors help contain odors
- Includes bolt-down capability
- Models FG396400 and FG9P9000 are Factory Manual (FM) approved when used with (sold separately) FG395800 and FG356300 Rigid Liners, respectively



FG9P9000BLA

The 35-gallon size is ideal for tight spaces.

NO.	COLOR	DESCRIPTION	GALLONS	LENGTH	WIDTH	HEIGHT
FG396400*	DGRN, BLA, BEIG	Plaza® Container	50.0	24.8"	25.3"	42.1"
FG9P9000*	BLA	Plaza® Jr. Container	35.0	21.4"	20.3"	41.1"
FG356300	BEIG	Rigid Liner for FG9P9000 Container	19.0	14.2"	N/A	28.0"
FG395800†	GRAY, BEIG	Rigid Liner for FG396400 Containers	35.0	19.5"	N/A	63.0"

*Rigid liner not included.

†FM-Approved

When ordering products with **BOLD** color codes, please specify color code after the product number. Refer to the Standard Color Guide at the back of the catalog.

Glutton®

Large-capacity containers for indoor/outdoor use.

- Perfect for large crowds and high-traffic areas
- Withstands extreme weather and handling
- Hold-down base can be filled with sand or water to provide added stability and security



ADA COMPLIANT



FG256V00RED



FG256B00BRN* / FG256V00BRN

NO.	COLOR	DESCRIPTION	GALLONS	LENGTH	WIDTH	HEIGHT
FG256B00*	BRN	Glutton® Container	56.0	25.5"	22.8"	31.1"
FG256V00	RED, BRN	Glutton® Hooded Top without doors for FG256B00 Containers	N/A	26.6"	23.0"	13.0"

*Rigid liner not included.

Americana Series™

The Americana Series™ offers rugged steel with multiple layers of powder coating to ensure years of trouble-free outdoor use.

- Adjustable leg levelers for stability on uneven surfaces
- Extremely heavy to deter theft and withstand harsh weather conditions



NO.	COLOR	DESCRIPTION	GALLONS	LENGTH	WIDTH	HEIGHT
FGMT32PLBK	BLACK	Americana Series™ Open Top	36.0	29.0"	29.0"	32.5"

UTILITY REFUSE AND RECYCLING

DECORATIVE REFUSE

CLEANING

MATERIAL HANDLING

WASHROOM

FOODSERVICE

ACCESSORIES & INDEX



Smokers' Pole

Simple, space-saving solution for controlling smokers' waste.

- Easy-to-empty design requires no tools and minimal bending
- Weather-resistant, powder-coated, fire-safe aluminum
- Recessed extinguishing screen



ADA COMPLIANT



1. Remove top using quick-release push-button.



2. Detach unit at midpoint, using quick-release push-button.



3. Empty contents.



NO.	COLOR	DESCRIPTION	GALLONS	LENGTH	WIDTH	HEIGHT
FG1	BK, SM	Smokers' Pole	N/A	4.0"	12.9"	42.3"

GroundsKeeper® Receptacles

Classic, all-weather solution to an unsightly environmental problem.

- Hygienic, easy-to-service steel canister
- Restricted opening shields waste from view, weather, and flow of oxygen
- Galvanized steel inner canister holds large quantities of cigarette waste
- Steel base plate adds stability and discourages theft
- Optional Weight Ring (FG628400) available for Safety Cones for added stability

FG9W3000's Tuscan style combines clean good looks with easy maintenance.

- Design blends with many styles
- Stainless steel snuff plate
- Anchor holes for added security



FG257088BEIG



FG9W3000SSTON



FG257088BLA

NO.	COLOR	DESCRIPTION	GALLONS	LENGTH	WIDTH	HEIGHT
FG257088	BLA, BEIG	GroundsKeeper® Smoking Management Receptacle	N/A	12.3"	N/A	39.4"
FG628400	BLA	Weight Ring	N/A	12.5"	12.5"	1.0"
FG9W29000000	—	Security Kit for GroundsKeeper® Tuscan Receptacle	N/A	N/A	N/A	N/A
FG9W3000	BLA, SSTON	GroundsKeeper® Tuscan Receptacle	N/A	13.0"	N/A	38.4"

When ordering products with **BOLD** color codes, please specify color code after the product number. Refer to the Standard Color Guide at the back of the catalog.

Aladdin Smokers' Station®

Weather-resistant, fire-safe steel construction will not burn.

- Factory Mutual-approved fire-safe/self-extinguishing
- Oxygen-restricting design quickly extinguishes cigarettes
- Nylon base pads prevent damage to surface and base
- Stainless steel latches and nickel-plated brass chain



Stainless steel latches require no tedious, time-consuming alignment to fasten. Forms a tight-fitting seal.



Top and base connected with nickel-plated brass chain to deter theft.

NO.	COLOR	DESCRIPTION	GALLONS	LENGTH	WIDTH	HEIGHT
FGR1639E	HGR	Aladdin Smokers' Station®	41.0	15.8"	15.8"	37.8"

Smoking Container Sand

The 5-lb sandbag is compatible with all smoking management products.

- Layers into smoking receptacles for convenient use
- Includes five 5-lb bags



FGB25

NO.	DESCRIPTION	FOR USE WITH:
FGB25	Black Sand, five 5-lb Bags	All Sand Urns

Metropolitan Smokers' Station

Metropolitan is a stylish all-metal, high-capacity smokers' station.



EASY TO EMPTY

Hinged lid flips open to provide complete access to the 1.6-gal galvanized liner. Simply lift out liner, discard waste, and reinsert.



WEIGHTED BASE AND BOLT-DOWN CAPABILITY

Base features holes for standard 3/8" lag or concrete bolts (not included) and is weighted for stability.

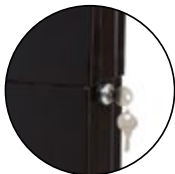

SECURITY FEATURES

Integrated keyed cam lock secures lid against tampering and helps reduce replacement costs.

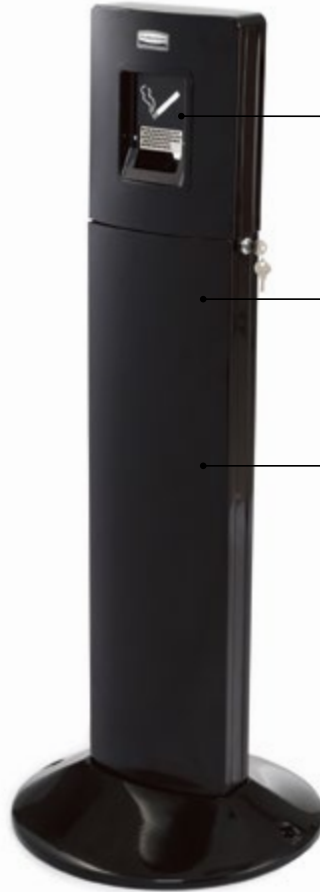

USER-FRIENDLY

Stainless steel snuff plates on both sides of unit.

WEATHERPROOF FINISH

Long-lasting Uni-Koat® powder-coated finish.

AESTHETIC AND DURABLE

All-metal construction in a slim, contemporary design.

NO.	COLOR	DESCRIPTION	GALLONS	LENGTH	WIDTH	HEIGHT
FGR93400	BK	Metropolitan Smokers' Station	1.6 Approx. 1,800 cigarettes	16.0"	16.0"	42.8"

Smokers' Station® Wall Mount

Simply snuff out cigarettes on the extinguishing screen and drop into the receptacle.

- Recessed extinguishing screen prevents ashes from falling to the ground
- Heavy-gauge, hot-dipped galvanized steel construction for fire-safety
- Mounting hardware included
- Keyed camlock helps prevent tampering



FGR1012EBK



Easy emptying.

NO.	COLOR	DESCRIPTION	GALLONS	LENGTH	WIDTH	HEIGHT
FGR1012E	BK	Smokers' Station® Wall-Mount Urn w/ Keyed Cam Lock	N/A	N/A	10.0"	12.5"

When ordering products with **BOLD** color codes, please specify color code after the product number. Refer to the Standard Color Guide at the back of the catalog.

Infinity™ Smoking Management

Sophisticated styling and all-metal construction for attractive and efficient smoking litter management.

- High-capacity receptacles for heavy traffic areas
- Stainless steel snuff plates
- Weighted bases and bolt-down options for added stability outdoors
- 360° disposal area
- Domed tops for weather resistance
- Integrated padlock tabs provide security against tampering and theft



CSFM



Recessed extinguishing screen snuffs small butts and avoids smoldering.



Curved cap prevents items or trash being placed on the top and water from entering the canister.



Integrated padlock tabs provide security against tampering and theft.



Holes to bolt to ground help the container remain stable and add security.



FG9W3200SSBLA



FG9W3100SSBLA



FG9W3300ATPWTR



FG9W3400BLA

NO.	COLOR	DESCRIPTION	GALLONS	LENGTH	WIDTH	HEIGHT
FG9W3200	SSBLA	Infinity™ Wall-Mount Smoking Receptacle	0.6	N/A	11.6"	18.0"
FG9W3100	SSBLA	Infinity™ Base-Mount Smoking Receptacle	N/A	N/A	15.5"	39.6"
FG9W3300	BLA, ATPWTR	Infinity™ Traditional Smoking Receptacle	4.1	N/A	13.0"	39.0"
FG9W3400	BLA	Infinity™ Ultra-High-Capacity Smoking Receptacle	6.7	N/A	15.5"	41.5"

UTILITY REFUSE AND RECYCLING

DECORATIVE REFUSE

CLEANING

MATERIAL HANDLING

WASHROOM

FOODSERVICE

ACCESSORIES & INDEX





CLEANING



2134283

HYGEN™ MICROFIBER

Why HYGEN™?	74
HYGEN™ Disposable Microfiber System	75
HYGEN™ Microfiber Cloths	76
HYGEN™ Flexi-Frame	77
HYGEN™ Microfiber Dust Mops	78
HYGEN™ Microfiber Damp Mops	79
HYGEN™ Quick-Connect Frames	80
HYGEN™ Quick-Connect Handles	81
HYGEN™ Microfiber Buckets	82
HYGEN™ PULSE™ Microfiber	
Spray Mop System	83
HYGEN™ Microfiber Quick-Connect Flexi-Wand and Duster	84

MICROFIBER

Adaptable Flat Mop Designed for WaveBrake®	86
Light Commercial Microfiber Cloths and Pads	87
FLOW™ Finishing Systems	88
Flat Mop Finishing	89
Flat Mop Finish System	89

WAVEBRAKE® MOPPING SYSTEMS

WaveBrake® Buckets and Wringers	93
WaveBrake® Institutional Bucket and Wringer	94
WaveBrake® Bucket and Casters	94
Tandem™ 31-Qt Bucket and Wringer Combo	95
WaveBrake® Wringers	95
WaveBrake® Dirty Water Buckets	95

WET MOP SELECTION GUIDE

Wet Mop Selection Guide	96
Reference Guide	98

PREMIUM WET MOPS

Web Foot® Mops	100
Web Foot® Microfiber Tube Mops	100
Web Foot® Microfiber String Mops	100
Web Foot® Blend Shrinkless® Mops	101
Web Foot® Finish Mops	101

MAXIMIZER™ WET MOPS

Maximizer™ Microfiber Blend Mops	102
----------------------------------	-----

STANDARD WET MOPS

Swinger Loop® Wet Mops	103
Super Stitch® Blend Mops	104
Super Stitch® Cotton Mops	104
Super Stitch® Finish Mops	104
Universal Headband Blend Mops	106
Universal Headband Rayon Mop	106
Universal Headband Cotton Mops	106

ECONOMY WET MOPS

Disposable Wet Mops	107
Dura Pro Blend Mops	107
Dura Pro Cotton Mops	107
Value Pro Cut-End Cotton and Rayon Wet Mops	108
Synthetic Blend Mops	108

SPECIALTY AND FINISH MOPS

Maintenance Mops	109
Rough-Floor Wet Mops	109

WET MOP HANDLES

Wet Mop Handles	110
-----------------	-----

MOPPING ACCESSORIES

BRUTE® Buckets	111
Pail and Mop Strainer Combination	111
Steel Sponge Mop/Double Pails	111



FG758088YEL

DUST MOPS

Dust Mop Selection Guide114
 Microfiber Looped-End Dust Mops.....114
 Twisted-Loop Dust Mops115
 Trapper® Dust Mops.....115
 Kut-A-Way® Dust Mops.....115
 Disposable Cut-End Blended Dust Mops.....116
 Disposable Cut-End Cotton Dust Mops116
 Snap-On Wire Dust Mop Frames.....116
 Snap-On Dust Mop Handles.....116
 Cut-to-Length Dust Mops117
 Overhead Dusting Tools.....117
 Lambswool Duster.....117
 Carpet Bonnets.....117

BROOMS

Assembled Push Brooms.....119
 MAXIMIZER™ Push-to-Center Brooms120
 Broom Handles120
 Angle Brooms.....121
 Corn Broom.....121
 Lobby Pro® Upright Dust Pans121

BRUSHES & CLEANING BRUSHES

Brush Construction Guide122
 Plastic-Handle Utility Brushes.....122
 Floor/Deck Scrub Brush123
 Scrub Brushes123
 Toilet Bowl Brushes and Holders.....123
 Wall Washer Kit124
 Counter Brushes/Whisk Broom/
 Heavy-Duty Dust Pans124

CLEANING TOOLS

Floor Squeegees125
 MAXIMIZER™ Wet/Dry Debris Pan125
 MAXIMIZER™ Heavy Duty Debris Pan125

HOUSEKEEPING CARTS

Executive Traditional Housekeeping Carts...128
 Executive Compact Housekeeping Cart.....129
 Motorized Kit and Accessories129
 Housekeeping Cart Bumper Kits.....129
 Housekeeping Cart Accessories.....130
 Traditional Housekeeping Cart Accessories ..131

QUICK CARTS

Executive Quick Carts132

CLEANING CARTS

High-Security Janitorial Cleaning Carts.....134
 High-Capacity Janitorial Cleaning Carts
 with Bins134
 High-Capacity Janitorial Cleaning Cart135
 Traditional Janitorial Cleaning Carts.....135
 Cleaning Cart Accessories.....136

MECHANICAL SWEEPERS

Executive Single-Action Basic
 Mechanical Sweeper.....139
 Executive Dual-Action Bristle
 Mechanical Sweeper.....139
 Executive Dual-Action Brushless
 Mechanical Sweeper.....139

TOOLS AND ACCESSORIES

Closet Organizer and Tool Holder140
 Ironing Organizers140
 Mobile Two-Step Stepstool140
 Executive Spray Bottle, 32-Oz.....141
 Deluxe Carry Caddy141

LOOK FOR THE SPECIALLY MARKED **EXECUTIVE SERIES™** PRODUCTS.

CLEANING

UTILITY REFUSE
AND RECYCLING

DECORATIVE REFUSE

CLEANING

MATERIAL HANDLING

WASHROOM

FOODSERVICE

ACCESSORIES
& INDEX

HYGEN™

WHY HYGEN™?

KILLING MICROBES DOESN'T MAKE THEM DISAPPEAR.

The CDC identifies cleaning as the first step in the disinfection process, because organic matter and debris interfere with the microbial inactivation of disinfectants.¹ HYGEN™ Disposable Microfiber assists in environmental cleaning by removing 99.7% or more of tested fungi, viruses, and bacteria.*



RECOMMENDED HEALTHCARE APPLICATIONS

Occupied Patient Room	HYGEN™ Disposable Microfiber Cloths
Discharged Patient Room	HYGEN™ Disposable Microfiber Cloths and Mop
OR Terminal	HYGEN™ Disposable Microfiber Cloths
ER	HYGEN™ Disposable Microfiber Cloths and Mop
ICU / Isolation Room	HYGEN™ Disposable Microfiber Cloths and Mop
Nurses' Station	HYGEN™ Disposable Microfiber Cloths
MRI / X-ray Station	HYGEN™ Disposable Microfiber Cloths and Mop

- Tested viruses: *Feline Calicivirus* (surrogate for Norovirus), Common human coronavirus OC43
- Tested Bacteria: Methicillin-resistant *Staphylococcus aureus* (MRSA), *Clostridioides difficile* (*C. diff*), *Pseudomonas aeruginosa*
- Tested Fungi: *Candida auris*
- Not tested on COVID-19

*Based on third-party testing on VCT surface with water alone | EPA Est. No 92100-CHN-1

¹Centers for Disease Control and Prevention. Guidelines for Environmental Infection Control in Health-Care Facilities. 2003. Available from: <https://www.cdc.gov/infectioncontrol/pdf/guidelines/environmental-guidelines-P.pdf>. Accessed 3 April 2020.

HYGEN™ DISPOSABLE MICROFIBER SYSTEM

The HYGEN™ Disposable Microfiber System is the solution for optimizing infection prevention, ensuring environmental hygiene and improving productivity.

Removes 99.7% or more of tested fungi, viruses, and bacteria, with water alone*

- Tested viruses: *Feline Calicivirus* (surrogate for Norovirus), Common human coronavirus OC43
- Tested Bacteria: Methicillin-resistant *Staphylococcus aureus* (MRSA), *Clostridioides difficile* (*C. diff*), *Pseudomonas aeruginosa*
- Tested Fungi: *Candida auris*
- Not tested on COVID-19

Superior Cleaning Performance

- Effectively removes dirt
- Great for cleaning mirrors, glass, and stainless steel

Versatile Cleaning

- Compatible with bleach and quat
- Ideal for dusting and wet cleaning
- Convenient charging system and compatible with existing tools



NO.	DESCRIPTION	SIZE	COLOR	CASE PACK SIZE	QUANTITY PER CASE
2134282	HYGEN 18" Disposable Microfiber Pad	18.0" l x 4.8" w	WH00	1	150 Pads
2134283	HYGEN 12" X 12" Disposable Microfiber Cloth	12.0" l x 12.0" w	WH00	1	600 Cloths
2135007	HYGEN 12" X 12" Disposable Microfiber Charging Tub for Cloth	7.8" l x 7.9" w x 7.4" h	WH00	1	4 Tubs

*Based on third party testing with water only on VCT surface. EPA Est. No 92100-CHN-1



HEALTHCARE

- Isolation room
- Discharged patient room
- Emergency room
- Intensive care unit



OFFICE BUILDINGS

- Lobby/reception area
- Conference room
- Break area
- Public restroom



SCHOOLS

- Classroom
- Administrative office
- Public restroom



RETAIL

- Retail fashion outlet
- Beauty salon



FOODSERVICE

- Front of house



HOSPITALITY

- Spa
- Health club
- Fitness studio

HYGEN™ Microfiber Cloths

HYGEN™ Microfiber Cloths are purposely designed to help Healthcare facilities reduce the risk of costly HAIs with superior efficacy and improved worker productivity vs. traditional cleaning solutions.

- Removes 99.9% or more of tested fungi, viruses, and bacteria, with water alone†
- Tested to withstand 200 launderings to CDC guidelines in hot water (160F) with chlorine bleach
- Patented zig-zag design is made of polyester for additional scrubbing power
- Helps reduce cross-contamination with color-coded cloths that encourage cleaning with different colors by area or task

**REDUCE CROSS-CONTAMINATION**

HYGEN™ Microfiber Cloths are color-coded to assist in cleaning by area or task and help reduce cross-contamination.

- Tested viruses: *Feline Calicivirus* (surrogate for Norovirus), Common human coronavirus OC43, SARS-CoV-2, Omicron Variant (Lineage B.1.1.529, BEI Resources #NR-56461)
- Tested Bacteria: Methicillin-resistant *Staphylococcus aureus* (MRSA), *Clostridioides difficile* (*C. diff*), *Pseudomonas aeruginosa*
- Tested Fungi: *Candida auris*

REMOVES
99.9% OR MORE
OF TESTED
PATHOGENS, WITH
WATER ALONE†



BLEACH-
SAFE
in hot & cold water

Certified to tolerate CDC hot and cold water laundering requirements*

DURABLE UP TO
500
launderings**
(up to 200 with bleach)

NO.	COLOR	DESCRIPTION	U.S. DIMENSIONS	U.S. SHIP WT/CTN	METRIC DIMENSIONS	METRIC SHIP WT/CTN	PACK
FGQ61000	YL00	HYGEN™ Microfiber Bathroom Cloth (Yellow)	16.0" l x 16.0" w	0.6 lb	40.6 cm x 40.6 cm	0.3 kg	12
FGQ62000	GR00, RD00, BL00	HYGEN™ Microfiber General-Purpose Cloth (Green, Red, or Blue)	16.0" l x 16.0" w	0.7 lb	40.6 cm x 40.6 cm	0.3 kg	12
FGQ62006	GR00	HYGEN™ Microfiber General-Purpose Cloth (Green)	16.0" l x 16.0" w	0.8 lb	40.6 cm x 40.6 cm	0.4 kg	6
FGQ63000	BL00	HYGEN™ Microfiber Glass/Mirror Cloth (Blue)	16.0" l x 16.0" w	1.8 lb	40.6 cm x 40.6 cm	0.8 kg	12
FGQ63006	BL00	HYGEN™ Microfiber Glass/Mirror Cloth (Blue)	16.0" l x 16.0" w	0.5 lb	40.6 cm x 40.6 cm	0.2 kg	6

† Based on third-party testing on VCT surface with water alone | EPA Est Nos. 91158-IND-1. Claim does not apply to Glass/Mirror Cloth.

* Always use cleaning chemicals or disinfectants as directed by your facility manager

** Based on internal testing without bleach

When ordering products with **BOLD** color codes, please specify color code after the product number. Refer to the Standard Color Guide at the back of the catalog.



HYGEN™ Flexi-Frame

Clean faster and more effectively.

- Frame conforms to curved surfaces for better pickup of dirt and debris
- Frame flexes to clean both contoured and flat surfaces
- The proprietary material withstands harsh chemicals, including bleach and peroxide



FGQ85500



FGQ85600



FGQ86100



FGQ87100



FGQ88100



FGQ89100

NO.	COLOR	DESCRIPTION	U.S. DIMENSIONS	U.S. SHIP WT/CTN	METRIC DIMENSIONS	METRIC SHIP WT/CTN	PACK
FGQ85500	BK00	11" HYGEN™ Microfiber Flexi-Frame	13.1" l x 5.4" w x 0.8" h	4.9 lb	33.3 cm x 13.7 cm x 2.0 cm	2.2 kg	6
FGQ85600	GR00	HYGEN™ Microfiber Flexi-Frame Duster Cover	8.9" l x 5.9" w x 0.3" h	1.4 lb	22.6 cm x 15.0 cm x 0.8 cm	0.6 kg	12
FGQ86100	WH00	11" HYGEN™ Microfiber Flexi-Frame Hi-Pile Cover	8.9" l x 5.9" w x 0.9" h	2.2 lb	22.6 cm x 15.0 cm x 2.3 cm	1.0 kg	12
FGQ87100	BL00	HYGEN™ Microfiber Flexi-Frame Glass Cover	8.9" l x 5.9" w x 0.9" h	1.1 lb	22.6 cm x 15.0 cm x 2.3 cm	0.5 kg	12
FGQ88100	YL00	HYGEN™ Microfiber Flexi-Frame Tub and Tile Cover	8.3" l x 8.3" w x 0.3" h	1.6 lb	21.1 cm x 21.1 cm x 0.8 cm	0.7 kg	12
FGQ89100	BL00	HYGEN™ Microfiber Flexi-Frame Damp Mop Cover	8.3" l x 8.3" w x 0.3" h	1.8 lb	21.1 cm x 21.1 cm x 0.8 cm	0.8 kg	12

HYGEN™ Microfiber Dust Mops

HYGEN™ Microfiber Dust Mops provide superior dust removal to help prevent the spread of infection.

- Trap and lock away dust, dirt, and debris
- Dust mopping prior to damp mopping helps reduce floor haze and best maintains floor finish
- Tested to withstand 200 launderings to CDC guidelines in hot water (160F) with chlorine bleach
- Industry-leading loop back is made of 100% polyester and securely attaches to frame, even after laundering



FGQ41200

FGQ41800

50% more surface area
HYGEN™ fringed dust mops provide significantly greater surface area versus nonfringed mops for faster cleaning. Available in widths up to 60".

**BLEACH-
SAFE**

in hot & cold water
Certified to tolerate CDC hot and cold water laundering requirements.*

**DURABLE UP TO
500
launderings****
(up to 200 with bleach)

Microfiber Dust Mops

NO.	COLOR	DESCRIPTION	U.S. DIMENSIONS	U.S. SHIP WT/CTN	METRIC DIMENSIONS	METRIC SHIP WT/CTN	PACK
FGQ41200	GR00	18" (45.7 cm) HYGEN™ Microfiber Room Dust Mop	21.0" l x 9.0" w x 0.5" h	1.4 lb	53.3 cm x 22.9 cm x 1.3 cm	0.6 kg	12

Microfiber Fringed Dust Mops

NO.	COLOR	DESCRIPTION	U.S. DIMENSIONS	U.S. SHIP WT/CTN	METRIC DIMENSIONS	METRIC SHIP WT/CTN	PACK
FGQ41800	GR00	18" (45.7 cm) HYGEN™ Microfiber Fringed Dust Mop	21.0" l x 9.0" w x 0.5" h	3.2 lb	53.3 cm x 22.9 cm x 1.3 cm	1.5 kg	6
FGQ42600	GR00	24" (61 cm) HYGEN™ Microfiber Fringed Dust Mop	27.5" l x 9.0" w x 0.5" h	3.5 lb	69.9 cm x 22.9 cm x 1.3 cm	1.6 kg	6
FGQ43800	GR00	36" (91.4 cm) HYGEN™ Microfiber Fringed Dust Mop	40.0" l x 9.0" w x 0.5" h	5.0 lb	101.6 cm x 22.9 cm x 1.3 cm	2.3 kg	6
FGQ44900	GR00	48" (121.9 cm) HYGEN™ Microfiber Fringed Dust Mop	52.0" l x 9.0" w x 0.5" h	6.8 lb	132.1 cm x 22.9 cm x 1.3 cm	3.1 kg	6
FGQ46000	GR00	60" (152.4 cm) HYGEN™ Microfiber Fringed Dust Mop	66.5" l x 9.0" w x 0.5" h	8.5 lb	168.9 cm x 22.9 cm x 1.3 cm	3.9 kg	6

* Always use cleaning chemicals or disinfectants as directed by your facility manager

** Based on internal testing without bleach

When ordering products with **BOLD** color codes, please specify color code after the product number. Refer to the Standard Color Guide at the back of the catalog.



HYGEN™ Microfiber Damp Mops

HYGEN™ Microfiber Pads are purposely designed to help Healthcare facilities reduce the risk of costly HAIs with superior efficacy and improved worker productivity vs. traditional cleaning solutions.

- Removes 99.9% or more of tested fungi, viruses, and bacteria, with water alone†
- Tested to withstand 200 launderings to CDC guidelines in hot water (160F) with chlorine bleach
- Patented zig-zag design is made of polyester and polypropylene to improve ease of use and provide additional scrubbing power
- Industry-leading loop back is made of 100% polyester and securely attaches to frame, even after laundering
- Help reduce cross-contamination with color-coded edge tape that encourages cleaning with different colors by area or task



FGQ81000



FGQ41000



1863895



FGQ41600

- Tested viruses: *Feline Calicivirus* (surrogate for Norovirus), Common human coronavirus OC43, SARS-CoV-2 Omicron Variant (Lineage B.1.1.529, BEI Resources #NR-56461)
- Tested Bacteria: Methicillin-resistant (MRSA), *Clostridioides difficile* (*C. diff*), *Pseudomonas aeruginosa*
- Tested Fungi: *Candida Auris*

BLEACH-SAFE

in hot & cold water
Certified to tolerate CDC hot and cold water laundering requirements.*

DURABLE UP TO
200
launderings**
(up to 100 with bleach)

NO.	COLOR	DESCRIPTION	U.S. DIMENSIONS	U.S. SHIP WT/CTN	METRIC DIMENSIONS	METRIC SHIP WT/CTN	PACK
FGQ82000	BLOO	11" (27.9 cm) HYGEN™ Microfiber Wall/Stair Damp Mop	13.0" l x 5.2" w x 0.5" h	1.5 lb	33.0 cm x 13.2 cm x 1.3 cm	0.7 kg	6
FGQ81000	YLOO	18" (45.7 cm) HYGEN™ Microfiber Super Scrubber Mop	20.5" l x 5.2" w x 0.5" h	2.0 lb	52.1 cm x 13.2 cm x 1.3 cm	0.9 kg	6
FGQ41000	GR00, RD00, BLOO	18" (45.7 cm) HYGEN™ Microfiber Damp Room Mop	20.5" l x 5.2" w x 0.5" h	2.9 lb	52.1 cm x 13.2 cm x 1.3 cm	1.3 kg	12
1863895	GRAY	Executive HYGEN™ 18" Microfiber Wet Pad	20.5" l x 5.2" w x 0.5" h	2.9 lb	52.1 cm x 13.2 cm x 1.3 cm	1.3 kg	12
FGQ41600	BLOO	18" (45.7 cm) HYGEN™ Microfiber High-Absorbency Mop	20.5" l x 5.2" w x 0.5" h	4.0 lb	52.1 cm x 13.2 cm x 1.3 cm	1.8 kg	6
FGQ41100	BLOO	24" (61.0 cm) HYGEN™ Microfiber Damp Room Mop	26.0" l x 5.2" w x 0.5" h	4.1 lb	66.0 cm x 13.2 cm x 1.3 cm	1.9 kg	12

† Based on third-party testing on VCT surface with water alone | EPA Est Nos. 91635-VNM-001, 92100-CHN-1. Claim does not apply to FGQ81000YL00.

* Always use cleaning chemicals or disinfectants as directed by your facility manager

** Based on internal testing without bleach.



HYGEN™ Quick-Connect Frames

Quick-Connect Frames feature a flat profile that slides easily under furniture and equipment. Trapezoidal shape improves cleaning in corners and other hard-to-reach areas.

- Lightweight aluminum construction is safe for MRI rooms
- Replaceable hook-and-loop strips attach to all HYGEN™ Microfiber Damp and Dust Mops
- Rounded plastic end caps help protect walls and furniture



FGQ56000



EXECUTIVE
SERIES™
1863893



**FGQ57000 24"
QUICK-CONNECT
FRAME WITH SQUEEGEE**
Features a unique pull-type squeegee
for water and debris collection.

FGQ57000



FGQ56000



FGQ55900

Quick-Connect Aluminum Frame

NO.	COLOR	DESCRIPTION	U.S. DIMENSIONS	U.S. SHIP WT/CTN	METRIC DIMENSIONS	METRIC SHIP WT/CTN	PACK
FGQ55000	YL00	11" (27.9 cm) HYGEN™ Quick-Connect Wet/Dry Frame	11.0" l x 3.0" w x 1.5" h	4.9 lb	27.9 cm x 7.6 cm x 3.8 cm	2.2 kg	6
FGQ56000	YL00	17" (43.2 cm) (45.7 cm) HYGEN™ Quick-Connect Wet/Dry Frame	17.0" l x 3.0" w x 1.5" h	6.5 lb	43.2 cm x 7.6 cm x 3.8 cm	2.9 kg	6
1863893	BLACK	Executive 17" (43.2 cm) HYGEN™ Quick-Connect Wet/Dry Frame	17.0" l x 3.0" w x 1.5" h	6.5 lb	43.2 cm x 7.6 cm x 3.8 cm	2.9 kg	6
FGQ57000	YL00	24" (61 cm) HYGEN™ Quick-Connect Wet/Dry Frame With Squeegee	24.0" l x 3.0" w x 1.5" h	9.2 lb	61.0 cm x 7.6 cm x 3.8 cm	4.2 kg	6
FGQ58000	YL00	35" (88.9 cm) HYGEN™ Quick-Connect Hall Dusting Frame	35.0" l x 3.0" w x 1.5" h	13.1 lb	88.9 cm x 7.6 cm x 3.8 cm	5.9 kg	6
FGQ59000	YL00	47" (119.4 cm) HYGEN™ Quick-Connect Hall Dusting Frame	47.0" l x 3.0" w x 1.5" h	16.7 lb	119.4 cm x 7.6 cm x 3.8 cm	7.6 kg	6
FGQ59500	YL00	59" (149.9 cm) HYGEN™ Quick-Connect Hall Dusting Frame	59.0" l x 3.0" w x 1.5" h	20.8 lb	149.9 cm x 7.6 cm x 3.8 cm	9.4 kg	6

Light Commercial Quick-Connect Frame

NO.	COLOR	DESCRIPTION	U.S. DIMENSIONS	U.S. SHIP WT/CTN	METRIC DIMENSIONS	METRIC SHIP WT/CTN	PACK
FGQ55900	BK00	Light Commercial 18" (45.7 cm) HYGEN™ Quick-Connect Frame	17.6" l x 3.0" w x 1.5" h	6.1 lb	44.7 cm x 7.6 cm x 3.8 cm	2.8 kg	6

Quick-Connect Frame Accessories

NO.	COLOR	DESCRIPTION	U.S. DIMENSIONS	U.S. SHIP WT/CTN	METRIC DIMENSIONS	METRIC SHIP WT/CTN	PACK
FGQ18000	BK00	17" (43.2 cm) HYGEN™ Hook-and-Loop Replacement Set for FGQ56000	14.7", 16.0" l x 1.1" w x 0.3" h	1.0 lb	37.3, 40.6 cm x 2.8 cm x 0.6 cm	0.04 kg	6
FGQ36000	BK00	35" (88.9 cm) HYGEN™ Hook-and-Loop Replacement Set for FGQ58000	32.6", 33.9" l x 1.1" w x 0.3" h	1.6 lb	82.8, 86.1 cm x 2.8 cm x 0.6 cm	0.7 kg	6

When ordering products with **BOLD** color codes, please specify color code after the product number. Refer to the Standard Color Guide at the back of the catalog.

HYGEN™ Quick-Connect Handles

Quick-Connect handles and poles make cleaning more efficient in every area of the facility. The unique connection mechanism allows for easy, time-saving tool exchange.

- Lightweight aluminum construction is safe for MRI rooms
- Handles available in straight or ergonomic bend styles, in adjustable lengths between 20" and 72"
- Extension poles make quick work of high-reach cleaning tasks, with lengths up to 18'



Large, comfortable grip provides better stability for cleaning high areas with extension poles.

Ergonomic Design for Worker Comfort



FGQ76000 (opens to 72")



Can be used in a push/pull "vacuum cleaner" style for comfortable cleaning of large areas.

OR



Uniquely shaped grip and ergonomic bend minimize awkward hand positions when cleaning with a "figure-8" motion.

Quick-Connect Handles and Extension Poles

NO.	COLOR	DESCRIPTION	U.S. DIMENSIONS	U.S. SHIP WT/CTN	METRIC DIMENSIONS	METRIC SHIP WT/CTN	PACK
FGQ74500	YL00	20"–40" (50.8 cm–101.6 cm) HYGEN™ Quick-Connect Short Extension Handle	Open: 40.0" l x 2.0" w x 2.0" h Closed: 20.0" l x 2.0" w x 2.0" h	6.5 lb	Open: 101.6 cm x 5.1 cm x 5.1 cm Closed: 50.8 cm x 5.1 cm x 5.1 cm	2.9 kg	6
FGQ75000	YL00	58" (147.3 cm) HYGEN™ Quick-Connect Handle	58.0" l x 1.6" w x 1.6" h	6.3 lb	147.3 cm x 4.1 cm x 4.1 cm	2.9 kg	6
FGQ75500	YL00	48"–72" (121.9 cm–182.9 cm) HYGEN™ Quick-Connect Straight Extension Handle	Open: 72.0" l x 2.0" w x 2.0" h Closed: 41.0" l x 2.0" w x 2.0" h	8.8 lb	Open: 182.9 cm x 5.1 cm x 5.1 cm Closed: 104.1 cm x 5.1 cm x 5.1 cm	4 kg	6
FGQ76000	0000	48"–72" (121.9 cm–182.9 cm) HYGEN™ Quick-Connect Ergo Adjustable Handle	Open: 72.0" l x 7.5" w x 2.5" h Closed: 48.0" l x 7.5" w x 2.5" h	8.7 lb	Open: 182.9 cm x 19.1 cm x 6.4 cm Closed: 121.9 cm x 19.1 cm x 6.4 cm	3.9 kg	6
FGQ76500	YL00	4'–8' HYGEN™ Quick-Connect Extension Pole	Open: 96.0" l x 2.1" w x 2.1" h Closed: 48.0" l x 2.1" w x 2.1" h	16.7 lb	Open: 243.8 cm x 5.3 cm x 5.3 cm Closed: 121.9 cm x 5.3 cm x 5.3 cm	7.6 kg	6
FGQ74900	YL00	Light Commercial 52" Quick-Connect Straight Handle	5.2" l x 1.0" w x 1.0" h	7.1 lb	132.1 cm x 2.5 cm x 2.5 cm	3.2 kg	6

HYGEN™ Microfiber Buckets

HYGEN™ Microfiber Buckets complete a highly efficient flat mop cleaning system.

Charging Bucket

- Use with HYGEN™ Microfiber Damp Mops and Quick-Connect tools for a continuous cleaning process
- Easy-to-clean, lightweight nonporous plastic construction
- Buckets work with all HYGEN™ Microfiber Cleaning Carts



FGQ95088

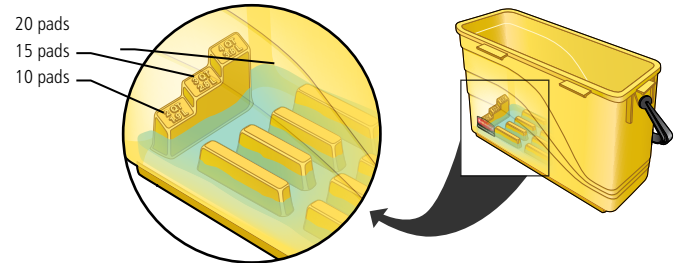

FGQ95088 Bucket design prevents oversaturation of microfiber mops and features a measuring guide for filling with cleaning and disinfecting solution before mops are added.

Press Wring Bucket

- Use when flood cleaning or heavier liquid lay-down is desired
- Press sieve provides easy, "no touch" wringing
- For use with single-sided microfiber flat mops up to 18" in length
- Nonmarking casters
- Floor drain for fast emptying
- Available in blue with lid (item FGQ93000) for floor finish application



FGQ90088



Unique, ribbed "washboard" surface removes dirt and debris from mops before wringing.

NO.	COLOR	DESCRIPTION	U.S. DIMENSIONS	U.S. SHIP WT/CTN	METRIC DIMENSIONS	METRIC SHIP WT/CTN	PACK
FGQ95088	YEL	HYGEN™ Charging Bucket	23.9" l x 9.5" w x 13.6" h	16.0 lb	60.7 cm x 24.1 cm x 34.6 cm	7.3 kg	3
FGQ90088	YEL	HYGEN™ Press Wring Bucket	14.5" l x 26.2" w x 16.1" h	10.0 lb	36.8 cm x 66.5 cm x 40.9 cm	4.6 kg	1

When ordering products with **BOLD** color codes, please specify color code after the product number. Refer to the Standard Color Guide at the back of the catalog.

HYGEN™ PULSE™ Microfiber Spray Mop System

PULSE™ Mop cleans more square feet in less time when used with **HYGEN™ Microfiber Damp Mops** for cleaner floors faster and easier.

- Patented onboard reservoir and solution system evenly dispense liquid behind the mop



PULSE™ CADDY
Holds enough solution to cover up to 10,000 sq. ft.

ES
EXECUTIVE SERIES™
1863884



LIGHTWEIGHT CONSTRUCTION
Weighs only 6lbs when fully loaded.

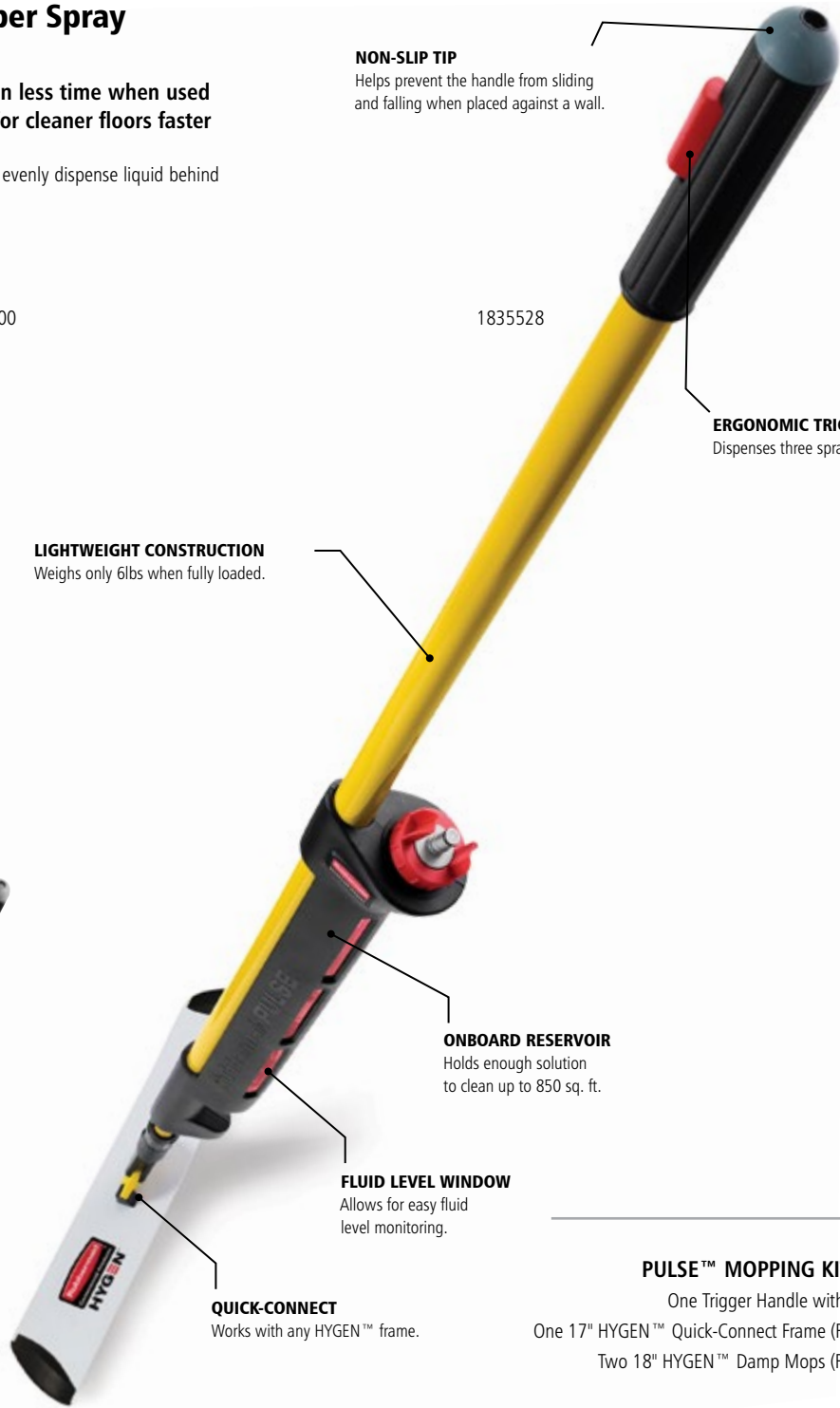

NON-SLIP TIP
Helps prevent the handle from sliding and falling when placed against a wall.

ERGONOMIC TRIGGER HANDLE
Dispenses three sprays of cleaner.

ONBOARD RESERVOIR
Holds enough solution to clean up to 850 sq. ft.

FLUID LEVEL WINDOW
Allows for easy fluid level monitoring.

QUICK-CONNECT
Works with any HYGEN™ frame.

PULSE™ MOPPING KIT INCLUDES:
One Trigger Handle with Fluid Reservoir
One 17" HYGEN™ Quick-Connect Frame (FGQ56000YL00)
Two 18" HYGEN™ Damp Mops (FGQ41000BL00)

NO.	COLOR	DESCRIPTION	U.S. DIMENSIONS	U.S. CAPACITY	U.S. SHIP WT/CTN	METRIC DIMENSIONS	METRIC CAPACITY	METRIC SHIP WT/CTN	PACK
1835528	YELLOW	HYGEN™ PULSE™ Mopping Kit with Single-Sided Frame	56.0" l x 4.9" w x 3.8" h	19.0 oz	5.7 lb	142.2 cm x 12.4 cm x 9.5 cm	0.6 L	2.6 kg	1
ES 1863884	SILVER	Executive HYGEN™ PULSE™ Microfiber Spray Mop, Single-Sided Flat Mop	56.0" l x 4.9" w x 3.8" h	19.0 oz	5.7 lb	142.2 cm x 12.4 cm x 9.5 cm	0.6 L	2.6 kg	1
FGQ96600	0000	HYGEN™ PULSE™ Caddy	14.1" l x 8.8" w x 10.8" h	2.0 gal	3.6 lb	35.9 cm x 22.2 cm x 27.3 cm	7.5 L	1.6 kg	1

HYGEN™ Microfiber Quick-Connect Flexi-Wand and Duster

Removes dust from crevices and hard-to-reach places.

- Duster frame conforms to the shape of the surface being cleaned for optimal surface contact and easily clean vents, furniture, bed covers, uniquely shaped fixtures, and more
- Quick-Connect Handle allows Flexi-Wand to be used with any of our telescoping handles (FGQ74500YL00, FGQ75500YL00)
- Thorough dust removal is critical to preventing the spread of infection and sustaining a clean environment



BLEACH-

SAFE

in hot & cold water

Certified to tolerate CDC hot and cold water laundering requirements*

FGQ85200



BETTER SURFACE CONTACT

Easily bends and conforms to irregular shapes to allow users to clean crown molding, tops of cabinets, and other areas. Washable duster sleeve slides on and off for easy replacement.

NO.	COLOR	DESCRIPTION	U.S. DIMENSIONS	U.S. SHIP WT/CTN	METRIC DIMENSIONS	METRIC SHIP WT/CTN	PACK
FGQ85000	BK00	HYGEN™ Quick-Connect Flexible Dusting Wand with Microfiber Sleeve	28.8" l x 3.3" w x 1.5" h	1.8 lb	73.0 cm x 8.3 cm x 3.8 cm	0.8 kg	6
FGQ85100	GR00	HYGEN™ Wand Duster Microfiber Replacement Sleeve	22.7" l x 3.3" w x 0.8" h	1.2 lb	57.7 cm x 8.3 cm x 1.9 cm	0.5 kg	6
⑤ FGQ85200	WH00	Executive 22" HYGEN™ Multipurpose Flexible Microfiber Duster and Frame	28.4" l x 1.1" w x 1.1" h	5.0 lb	72.1 cm x 2.9 cm x 2.9 cm	2.3 kg	6
⑤ FGQ85300	WH00	Executive 22" HYGEN™ Multipurpose Flexible Microfiber Duster	12.3" l x 7.0" w x 0.7" h	2.8 lb	31.2 cm x 17.8 cm x 1.9 cm	1.3 kg	6

* Always use cleaning chemicals or disinfectants as directed by your facility manager



FGQ85200WH00

When ordering products with **BOLD** color codes, please specify color code after the product number. Refer to the Standard Color Guide at the back of the catalog.



UTILITY REFUSE
AND RECYCLING

DECORATIVE REFUSE

CLEANING

MATERIAL HANDLING

WASHROOM

FOODSERVICE

ACCESSORIES
& INDEX

1835528 / FGQ41000BL00

www.rubbermaidcommercial.com



Adaptable Flat Mop Designed for WaveBrake®

The Adaptable Flat Mop Kit is made for ergonomic microfiber mopping in large spaces using your existing WaveBrake® Side-Press Mop Bucket.

- Adaptable Flat Mop microfiber pads can be laundered up to 200 times (100 with bleach)



WAVEBRAKE® COMPATIBILITY, INCREASED PRODUCTIVITY

A new microfiber mopping system that works with your trusted WaveBrake® Side-Press mop bucket.



BETTER CLEAN WITH LESS EFFORT

Microfiber pad weighs 70% less when fully saturated[†], reducing user strain.



MAXIMUM ABSORBENCY

7% more absorbent** allowing for greater floor coverage.



REMOVES BACTERIA & VIRUSES

Microfiber pad removes 99.7% or more of tested viruses and bacteria.¹



NO-TOUCH PAD DISPOSAL

Convenient clips help avoid contact with soiled mop pad during disposal.



2132426

THE WRINGABLE MICROFIBER MOPPING SYSTEM

allows you to integrate microfiber mopping into your current cleaning process, using your existing WaveBrake® Mop Bucket, with the benefit of mopping 15% faster.**

NO.	COLOR	DESCRIPTION	U.S. DIMENSIONS	U.S. SHIP WT/CTN	METRIC DIMENSIONS	METRIC SHIP WT/CTN	PACK
2132426	BLACK	Adaptable Flat Mop Kit* Designed for WaveBrake®	42.0" l x 9.0" w x 3.5" h	4.0 lb	106.7 cm x 22.9 cm x 8.9 cm	1.8 kg	1
2132428	BLACK	Adaptable Flat Mop 18" Frame Designed for WaveBrake®	18.3" l x 4.0" w x 1.8" h	14.4 lb	46.4 cm x 10.2 cm x 4.5 cm	6.5 kg	12
2132427	BLUE	Adaptable Flat Mop Microfiber 18" Pad	19.5" l x 5.5" w x 0.4" h	3.7 lb	49.5 cm x 14.0 cm x 0.9 cm	1.7 kg	12
2132431	GREEN	Adaptable Flat Mop Microfiber 18" Pad	19.5" l x 5.5" w x 0.4" h	3.7 lb	49.5 cm x 14.0 cm x 0.9 cm	1.7 kg	12
2132423	RED	Adaptable Flat Mop Microfiber 18" Pad	19.5" l x 5.5" w x 0.4" h	3.7 lb	49.5 cm x 14.0 cm x 0.9 cm	1.7 kg	12
2132425	BLACK	Adaptable Flat Mop Wringer Insert Designed for WaveBrake®	8.5" l x 8.4" w x 1.5" h	2.6 lb	21.6 cm x 21.3 cm x 3.8 cm	1.2 kg	12
FGQ75500	YLOO	48"-72" HYGEN™ Quick-Connect Straight Extension Handle	Open: 72.0" l x 2.0" w x 2.0" h Closed: 41.0" l x 2.0" w x 2.0" h	8.8 lb	Open: 182.9 cm x 5.1 cm x 5.1 cm Closed 104.1 cm x 5.1 cm x 5.1 cm	4.0 kg	6

* Kit includes (1) Frame, (2) Blue Mop Pads, (1) Wringer Insert, (1) 48" - 72" HYGEN™ Quick-Connect Extension Handle.

** Based on third party testing vs RCP 24oz Super Stitch Blend Wet Mop

[†] vs. RCP Super Stitch Cotton String Mop.

¹ Tested with water alone on VCT surfaces. TESTED VIRUS: Feline Calicivirus (surrogate for Norovirus): 99.94% | TESTED BACTERIA: MRSA: 99.90%, Pseudo: 99.92%, C.diff: 99.94%.

Not tested on SARS-CoV-2, the virus that causes COVID-19. EPA Est. No 92100-CHN-1.

When ordering products with **BOLD** color codes, please specify color code after the product number. Refer to the Standard Color Guide at the back of the catalog.

Light Commercial Microfiber Cloths and Pads

Commercial-grade microfiber helps clean surfaces more effectively than traditional cotton tools to help facilitate cleaner, healthier facilities.

- Tested to withstand 100 launderings to CDC guidelines in hot water (160F) with chlorine bleach, or 200 launderings without bleach.
- Help reduce cross-contamination with color-coded cloths that encourage cleaning with different colors by area or task

**REMOVES
99.9%
OR MORE
OF TESTED FUNGI
AND BACTERIA, WITH
WATER ALONE***
Applies to cloths only.

- Tested Bacteria: Methicillin-resistant *Staphylococcus aureus* (MRSA), *Clostridioides difficile* (C. diff), *Pseudomonas aeruginosa*
- Tested Fungi: *Candida auris*
- Not tested on COVID-19
- Claim does not apply to FGQ40800 and FGQ40900



1820582 / 1820581 / 1820584 / 1820583



3486108



FGQ40800GR00



FGQ40900BL00



FGQ55900BK00



FGQ74900YL00

NO.	COLOR	DESCRIPTION	U.S. DIMENSIONS	U.S. SHIP WT/CTN	METRIC DIMENSIONS	METRIC SHIP WT/CTN	PACK
1820577	PINK	12" x 12" Microfiber Light Commercial Cloth	12.0" l x 12.0" w	13.8 lb	30.5 cm x 30.5 cm	6.3 kg	288
1820578	GREEN	12" x 12" Microfiber Light Commercial Cloth	12.0" l x 12.0" w	13.8 lb	30.5 cm x 30.5 cm	6.3 kg	288
1820579	BLUE	12" x 12" Microfiber Light Commercial Cloth	12.0" l x 12.0" w	13.8 lb	30.5 cm x 30.5 cm	6.3 kg	288
1820580	YELLOW	12" x 12" Microfiber Light Commercial Cloth	12.0" l x 12.0" w	13.8 lb	30.5 cm x 30.5 cm	6.3 kg	288
1820581	PINK	16" x 16" Microfiber Light Commercial Cloth	16.0" l x 16.0" w	13.8 lb	40.6 cm x 40.6 cm	6.3 kg	288
1820582	GREEN	16" x 16" Microfiber Light Commercial Cloth	16.0" l x 16.0" w	13.8 lb	40.6 cm x 40.6 cm	6.3 kg	288
1820583	BLUE	16" x 16" Microfiber Light Commercial Cloth	16.0" l x 16.0" w	13.8 lb	40.6 cm x 40.6 cm	6.3 kg	288
1820584	YELLOW	16" x 16" Microfiber Light Commercial Cloth	16.0" l x 16.0" w	13.8 lb	40.6 cm x 40.6 cm	6.3 kg	288
FGQ40900	BL00	18" Light Commercial Microfiber Damp Mop	20.0" l x 5.0" w x 0.5" h	1.8 lb	50.8 cm x 12.7 cm x 1.3 cm	0.8 kg	12
FGQ40800	GR00	18" Light Commercial Microfiber Fringed Dust Mop	20.0" l x 8.0" w x 0.5" h	3.0 lb	50.8 cm x 20.3 cm x 1.3 cm	1.3 kg	12
FGQ55900	BK00	18" Light Commercial Quick-Connect Wet/Dry Plastic Frame	17.6" l x 3.0" w x 1.5" h	6.1 lb	44.7 cm x 7.6 cm x 3.8 cm	2.8 kg	6
FGQ74900	YL00	52" Light Commercial Quick-Connect Steel Handle	52.0" l x 1.0" w x 1.0" h	7.1 lb	132.1 cm x 2.5 cm x 2.5 cm	3.2 kg	6
3486108	N/A	Light Commercial Microfiber Spray Mop (mop pad not included)	52.0" l x 4.5" w x 3.5" h	3.0 lb	132.1 cm x 11.4 cm x 8.9 cm	1.4 kg	1

* Based on third-party testing on VCT surface with water alone | EPA Est. No 92100-CHN-1. Claim does not apply to FGQ40800 & FGQ40900.

FLOW™ Finishing Systems

Help reduce labor costs and improve worker productivity and well-being with the highly portable FLOW™ Floor Finishing System. High-capacity backpack and handle system allows user-controlled release of solution for more efficient floor finishing.

FGQ97900 FLOW™ FLAT MOP FINISH KIT

INCLUDES:

Backpack, Trigger Handle, 17" Quick-Connect Frame, and FGQ80500 FLOW™ Nylon Flat Mop

CLEAN CONNECT™ TECHNOLOGY:

Backpack hose connects to the trigger handle using Clean Connect™ technology for spill-free delivery of finish solution.

STRING MOP OR FLAT MOP OPTIONS

Kit includes an FGQ80500 FLOW™ Nylon Flat Mop. It connects easily to the handle using Quick-Connect.

TRIGGER HANDLE

Red ergonomic trigger handle dispenses finish solution with each press.

IMPROVED COMFORT

Backpack features venting channels to improve airflow and reduce moisture on back while wearing.

PROTECTS WORKER WELL-BEING

Chest and waist straps distribute weight onto user's hips instead of shoulders, reducing user strain.



High-Capacity Backpack System

FLOW™ holds 1.5 gallons for finishing up to 3,000 sq ft of floor surface. The 3" diameter opening makes refilling easy.

NO.	COLOR	DESCRIPTION	U.S. DIMENSIONS	U.S. CAPACITY	U.S. SHIP WT/ CTN	METRIC DIMENSIONS	METRIC CAPACITY	METRIC SHIP WT/ CTN	PACK
FGQ97900	YLOO	FLOW™ Flat Mop Finish Kit	56.0" l x 9.8" w x 3.8" h	1.5 gal	8.2 lb	142.2 cm x 24.8 cm x 9.5 cm	5.7 L	3.7 kg	1
FGQ80500	WH00	FLOW™ Nylon Flat Mop	6.5" l x 3.2" w x 19.7" h	N/A	5.0 lb	16.5 cm x 8.0 cm x 50.0 cm	N/A	2.3 kg	6

Flat Mop Finishing

Finish Bucket

Same features as the Microfiber Press Wring Bucket, in the blue color most often associated with finish applications.

Finish Pad

Produce beautiful, professional results easier and quicker than traditional methods.

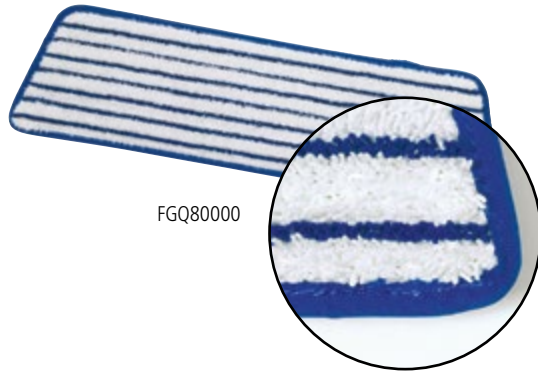

FGQ80000



FGQ93000

Flat Mop Finish System

Helps ensure controlled absorption and release of finish.

- Delivers 200–300 square feet (18.6 m²–27.9 m²) of coverage with a single mop load of finish
- Nylon fibers for the fastest and smoothest finish application
- Resealable Finish Bucket (FGQ93000) keeps finish fresh until the next job, saving cleanup time
- Smooth, nonporous bucket cleans easily, reducing time spent on stripping traditional mop bucket/wringer combinations



FGQ05000

Flat Mop Finishing

NO.	COLOR	DESCRIPTION	U.S. DIMENSIONS	U.S. SHIP WT/CTN	METRIC DIMENSIONS	METRIC SHIP WT/CTN	PACK
FGQ80000	WH00	18" (45.7 cm) Flat Mop	18.0" l x 5.5" w x 0.5" h	1.9 lb	45.7 cm x 14.0 cm x 1.3 cm	0.9 kg	6
FGQ93000	BLUE	Finish Bucket	14.7" l x 26.2" w x 16.2" h	12.1 lb	37.3 cm x 66.5 cm x 41.1 cm	5.5 kg	1

Flat Mop Finish System

NO.	COLOR	DESCRIPTION	U.S. DIMENSIONS	U.S. CAPACITY	U.S. SHIP WT/CTN	METRIC DIMENSIONS	METRIC CAPACITY	METRIC SHIP WT/CTN	PACK
FGQ05000	0000	Flat Mop, Includes Bucket with Lid, Sieve, 6 Pads, 1 Frame	18.0" l x 5.0" w	22.0 qt	10.6 lb	45.7 cm x 12.7 cm	20.8 L	4.8 kg	1
FGE05200	WH00	18" Microfiber Finish Loop Dust Mop	18.0" l x 5.0" w	N/A	5.0 lb	45.7 cm x 12.7 cm	N/A	2.3 kg	6

UTILITY REFUSE
AND RECYCLING

DECORATIVE REFUSE

CLEANING

MATERIAL HANDLING

WASHROOM

FOODSERVICE

ACCESSORIES
& INDEX



WAVEBRAKE®

Rubbermaid Commercial Products introduced the first resin mop bucket in 1974. The BRUTE® mop bucket was introduced in 1995 with new ergonomic features. WaveBrake® was introduced in 2005 with a patented bucket and baffle design that reduced splashing for more efficient, safer mopping.

Rubbermaid Commercial Products continues to innovate, improving the industry-leading splash reduction and adding new features that surpass any other traditional mop bucket. These features help the WaveBrake® clean floors with less effort to get the job done safer.

Proudly made in Winchester, Virginia, WaveBrake® features structural web-molded plastic construction to ensure the highest quality and durability you have come to expect while delivering industry-leading performance.

DESIGNED FOR PROFESSIONALS



UTILITY REFUSE
AND RECYCLING

DECORATIVE REFUSE

CLEANING

MATERIAL HANDLING

WASHROOM

FOODSERVICE

ACCESSORIES
& INDEX



UP TO 80% LESS SPLASH¹

Patented WaveBrake[®] baffles result in less splashing while mopping and maneuvering, helping to create a safer environment for patrons and staff.



EASY TO EMPTY

An optional built-in drain eliminates the strain of lifting and bending when emptying mop buckets. Integrated handles help ensure a secure grip to lift and empty the mop bucket.



5-YEAR WRINGER GUARANTEE²

The side-press and down-press wringers are designed to last 5 years or 200,000 wringing cycles.

¹ Versus competitive 35Qt U.S. single compartment mop bucket and wringer, not including divider bucket and accessories. ² Based on internal side-press testing.

COLOR-CODED CLEANING

Cleaning professionals today use a color-coded cleaning system, using color-coded buckets, handles and mops to help reduce cross-contamination. Additionally, they can be organized by function, department or building area, making it easier to track usage.

RECOMMENDED USAGE:

Color-coding systems can vary by vertical and application; however, Rubbermaid Commercial Products, in alignment with industry experts, recommends the following system:

- **Yellow:** Back-of-House Cleaning
- **Brown:** Back-of-House Cleaning
- **Red:** High-Risk Restroom Areas
- **Blue:** General-Purpose Cleaning
- **Green:** General Food Processing, Serving and Bar Areas
- **Black:** Front-of-House Cleaning



WaveBrake® Buckets and Wringers

With features that surpass traditional mop buckets, the WaveBrake® helps to clean floors with less effort to get the job done safer, without sacrificing quality and durability.

- **IMPROVE SAFETY AND PRODUCTIVITY:** Patented WaveBrake® baffles result in less splashing while mopping and maneuvering, helping to create a safer environment for patrons and staff. Additionally, water stays in the bucket, eliminating unnecessary trips to the storage closet to fill up the bucket, enhancing productivity
- **80% LESS SPLASHING:** Molded-in WaveBrake® baffles disrupt wave formation, reducing splash up to 80% versus leading competitors*
- **CONVENIENT TO EMPTY:** The new generation of the WaveBrake® mop bucket is designed to safely empty water with less effort. Integrated handles, sink ledge, and a pour spout provide control while lifting and emptying, for a safe and stable emptying process
- **DESIGNED TO LAST:** The new generation WaveBrake® wringer is designed and built to the highest of quality standards. WaveBrake® wringers have an industry-leading warranty of 5-years
- **INTEGRATED HANDLES AND SINK LEDGE:** Lift and empty the mop bucket easily, with less strain
- **POUR SPOUT:** Helps prevent water from spilling onto floors while emptying dirty water, to help floor remain dry and safe



COLORS AVAILABLE:



WaveBrake® Side-Press Bucket and Wringer

NO.	COLOR	DESCRIPTION	U.S. DIMENSIONS	U.S. SHIP WT	U.S. CAPACITY	METRIC DIMENSIONS	METRIC SHIP WT	METRIC CAPACITY	PACK
FG748000	YEL	26 qt WaveBrake® Side-Press Bucket and Wringer	18.9" l x 16.6" w x 23.5" h	20.7 lb	26.0 qt	47.9 cm x 42.2 cm x 59.7 cm	9.4 kg	24.6 L	1
FG758088	YEL	35 qt WaveBrake® Side-Press Bucket and Wringer	20.3" l x 16.4" w x 21.3" h	21.6 lb	35.0 qt	51.6 cm x 41.8 cm x 54.9 cm	9.8 kg	33.1 L	1
FG758088	BRN	35 qt WaveBrake® Side-Press Bucket and Wringer	20.3" l x 16.4" w x 21.3" h	21.6 lb	35.0 qt	51.6 cm x 41.8 cm x 54.9 cm	9.8 kg	33.1 L	1
FG758888	BLUE	35 qt WaveBrake® Side-Press Bucket and Wringer	20.3" l x 16.4" w x 21.6" h	21.6 lb	35.0 qt	51.6 cm x 41.8 cm x 54.9 cm	9.8 kg	33.1 L	1
FG758888	RED	35 qt WaveBrake® Side-Press Bucket and Wringer	20.3" l x 16.4" w x 21.6" h	21.6 lb	35.0 qt	51.6 cm x 41.8 cm x 54.9 cm	9.8 kg	33.1 L	1
FG758888	GRN	35 qt WaveBrake® Side-Press Bucket and Wringer	20.3" l x 16.4" w x 21.6" h	21.6 lb	35.0 qt	51.6 cm x 41.8 cm x 54.9 cm	9.8 kg	33.1 L	1
1863896	BLACK	Executive 35 qt WaveBrake® Side-Press Bucket and Wringer	30.2" l x 16.6" w x 20.5" h	24.4 lb	35.0 qt	76.7 cm x 42.1 cm x 52.1 cm	11.1 kg	33.1 L	1
2031764	YELLOW	35 qt WaveBrake® Side-Press Bucket and Wringer with Drain	20.3" l x 16.4" w x 21.6" h	21.6 lb	35.0 qt	51.6 cm x 41.8 cm x 54.9 cm	9.8 kg	33.1 L	1
FG618688	YEL	44 qt WaveBrake® Side-Press Bucket and Wringer with Drain	23.6" l x 16.8" w x 19.8" h	21.6 lb	44.0 qt	60.0 cm x 42.7 cm x 50.2 cm	9.8 kg	41.6 L	1

WaveBrake® Down-Press Bucket and Wringer

NO.	COLOR	DESCRIPTION	U.S. DIMENSIONS	U.S. SHIP WT	U.S. CAPACITY	METRIC DIMENSIONS	METRIC SHIP WT	METRIC CAPACITY	PACK
FG757788	YEL	35 qt WaveBrake® Down-Press Bucket and Wringer	20.3" l x 16.4" w x 21.6" h	21.6 lb	35.0 qt	51.6 cm x 41.8 cm x 54.9 cm	9.8 kg	33.1 L	1
FG757788	BRN	35 qt WaveBrake® Down-Press Bucket and Wringer	20.3" l x 16.4" w x 21.6" h	21.6 lb	35.0 qt	51.6 cm x 41.8 cm x 54.9 cm	9.8 kg	33.1 L	1
FG757888	BLUE	35 qt WaveBrake® Down-Press Bucket and Wringer	20.3" l x 16.4" w x 21.6" h	21.6 lb	35.0 qt	51.6 cm x 41.8 cm x 54.9 cm	9.8 kg	33.1 L	1
FG757888	RED	35 qt WaveBrake® Down-Press Bucket and Wringer	20.3" l x 16.4" w x 21.6" h	21.6 lb	35.0 qt	51.6 cm x 41.8 cm x 54.9 cm	9.8 kg	33.1 L	1
1863898	BLACK	Executive 35 qt WaveBrake® Down-Press Bucket and Wringer	30.2" l x 16.6" w x 27.8" h	22.3 lb	35.0 qt	76.7 cm x 42.1 cm x 70.5 cm	10.1 kg	33.1 L	1
FG757688	YEL	44 qt WaveBrake® Down-Press Bucket and Wringer with Drain	28.8" l x 17.0" w x 23.5" h	27.3 lb	44.0 qt	60.5 cm x 43.2 cm x 59.7 cm	12.4 kg	41.6 L	1

* 35 qt single compartment mop bucket and wringer, not including divider bucket and accessories versus leading U.S. competitive.



WaveBrake® Institutional Bucket and Wringer

With features that surpass traditional mop buckets, the new generation of WaveBrake® helps to clean floors with less effort to get the job done safer, without sacrificing quality and durability.

- **IMPROVE SAFETY AND PRODUCTIVITY:** Patented WaveBrake® baffles result in less splashing while mopping and maneuvering, helping to create a safer environment for patrons and staff. Additionally, water stays in the bucket, eliminating unnecessary trips to the storage closet to fill up the bucket, enhancing productivity
- **80% LESS SPLASHING:** Molded-in WaveBrake® baffles disrupt wave formation, reducing splash up to 80% versus leading competitors*
- **CONVENIENT TO EMPTY:** The new generation of the WaveBrake® mop bucket is designed to safely empty water with less effort. Integrated handles, sink ledge, and a pour spout provide control while lifting and emptying, for a safe and stable emptying process
- **INTEGRATED HANDLES AND SINK LEDGE:** Lift and empty the mop bucket easily, with less strain
- **POUR SPOUT:** Helps prevent water from spilling onto floors while emptying dirty water, to help floor remain dry and safe
- The WaveBrake® Institutional Mop Bucket and Wringer features non-metal construction ideal for correctional facilities and healthcare.



NO.	COLOR	DESCRIPTION	U.S. DIMENSIONS	U.S. SHIP WT	U.S. CAPACITY	METRIC DIMENSIONS	METRIC SHIP WT	METRIC CAPACITY	PACK
FG759088	YEL	35 qt WaveBrake® Institutional Bucket and Sieve Wringer	20.1" l x 16.8" w x 20.5" h	14.0 lb	35.0 qt	51.1 cm x 42.6 cm x 52.1 cm	6.3 kg	33.1 L	1

WaveBrake® Bucket and Casters

With features that surpass traditional mop buckets, the new generation of WaveBrake® helps to clean floors with less effort to get the job done safer, without sacrificing quality and durability.

- **IMPROVE SAFETY AND PRODUCTIVITY:** Patented WaveBrake® baffles result in less splashing while mopping and maneuvering, helping to create a safer environment for patrons and staff. Additionally, water stays in the bucket, eliminating unnecessary trips to the storage closet to fill up the bucket, enhancing productivity
- **80% LESS SPLASHING:** Molded-in WaveBrake® baffles disrupt wave formation, reducing splash up to 80% versus leading competitors*
- **CONVENIENT TO EMPTY:** The new generation of the WaveBrake® mop bucket is designed to safely empty water with less effort. Integrated handles, sink ledge, and a pour spout provide control while lifting and emptying, for a safe and stable emptying process
- **INTEGRATED HANDLES AND SINK LEDGE:** Lift and empty the mop bucket easily, with less strain
- **POUR SPOUT:** Helps prevent water from spilling onto floors while emptying dirty water, to help floor remain dry and safe
- **SECURE WRINGER CONNECTIONS:** Integrated wringer-guides ensure a secure connection to mop bucket, providing stability while wringing and maneuvering, to help prevent spills



NO.	COLOR	DESCRIPTION	U.S. DIMENSIONS	U.S. SHIP WT	U.S. CAPACITY	METRIC DIMENSIONS	METRIC SHIP WT	METRIC CAPACITY	PACK
2064914	YELLOW	35 qt WaveBrake® Bucket and Casters	20.3" l x 16.1" w x 17.3" h	43.0 lb	35.0 qt	51.4 cm x 40.8 cm x 43.9 cm	19.5 kg	33.1 L	4

* 35 qt single compartment mop bucket and wringer, not including divider bucket and accessories versus leading U.S. competitive.

Tandem™ 31-Qt Bucket and Wringer Combo

All-in-one compact design for effective wringing and no more lost parts.

- One-piece design: integrated bucket and wringer
- Holes in both wringing plates force more water from mop in less time
- 2½" casters for excellent maneuverability
- Built-in lift handles on bottom of bucket make lifting and emptying easier
- Accepts up to 24-oz mops



NO.	COLOR	DESCRIPTION	U.S. DIMENSIONS	U.S. SHIP WT/CTN	U.S. CAPACITY	METRIC DIMENSIONS	METRIC SHIP WT	METRIC CAPACITY	PACK
FG738000	YEL	Tandem™ 31-Qt Bucket and Wringer Combo	22.6" l x 13.3" w x 32.3" h	11.8 lb	31.0 qt	57.5 cm x 33.7 cm x 81.9 cm	5.4 kg	29.0 L	1

WaveBrake® Wringers

The new generation WaveBrake® wringer is designed and built to the highest of quality standards. WaveBrake® wringers have an industry-leading warranty of 5-years.

- 5-YEAR WRINGER GUARANTEE: The side-press and down-press wringers are designed to last 5-years or 200,000 cycles
- SECURE WRINGER CONNECTIONS: Integrated wringer-guides ensure a secure connection to mop bucket, providing stability while wringing and maneuvering, to help prevent spills
- WRINGS A VARIETY OF MOP SIZES: Wringer effectively wrings a variety of mop sizes, ranging from XS – XL (10oz – 32oz)
- DURABLE WRINGER HANDLE: Handle is made from steel, with a comfort grip for long-lasting durability

COLORS AVAILABLE:



2064915



2064959

NO.	COLOR	DESCRIPTION	U.S. DIMENSIONS	U.S. SHIP WT	U.S. CAPACITY	METRIC DIMENSIONS	METRIC SHIP WT	METRIC CAPACITY	PACK
2064915	YELLOW	WaveBrake® Side-Press Wringer	15.8" l x 13.4" w x 31.1" h	22.3 lb	N/A	40.0 cm x 34.0 cm x 79.1 cm	10.1 kg	N/A	2
2064960	BLACK	Executive WaveBrake® Side-Press Wringer	15.8" l x 13.4" w x 31.1" h	22.3 lb	N/A	40.0 cm x 34.0 cm x 79.1 cm	10.1 kg	N/A	2
2064959	YELLOW	WaveBrake® Down-Press Wringer	12.8" l x 11.9" w x 39.9" h	21.3 lb	N/A	32.5 cm x 30.3 cm x 101.3 cm	9.7 kg	N/A	2
2064994	BLACK	Executive WaveBrake® Down-Press Wringer	12.8" l x 11.9" w x 39.9" h	21.3 lb	N/A	32.5 cm x 30.3 cm x 101.3 cm	9.7 kg	N/A	2

WaveBrake® Dirty Water Buckets

Keeping the dirty water separate from clean water, the dirty water bucket helps to reduce the potential for cross-contamination. Executive Series™ WaveBrake® models include the dirty water bucket as standard.



2064907

NO.	COLOR	DESCRIPTION	U.S. DIMENSIONS	U.S. SHIP WT	U.S. CAPACITY	METRIC DIMENSIONS	METRIC SHIP WT	METRIC CAPACITY	PACK
2064907	RED	WaveBrake® Dirty Water Bucket for 35 qt or 44 qt	15.2" l x 9.8" w x 14.0" h	15.0 lb	18.0 qt	38.6 cm x 24.8 cm x 35.6 cm	6.8 kg	17.3 L	6

MOP CONSTRUCTION DEFINED

YARN TYPE

Mop yarn type is the most impactful driver of mop launderability, absorbency, durability, and release. Understanding mop yarn type helps drive proper mop selection for varying applications.



MICROFIBER TUBE

Most durable, stands up to abrasive cleaning and heavy-duty scrubbing with excellent absorbency.



FINISH

Designed to provide smooth and even release of chemical and floor finish. Less linting compared to rayon.

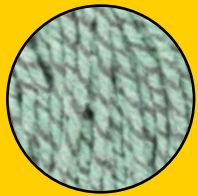

MICROFIBER

Highly durable, non-abrasive general-purpose mop.



RAYON

General-purpose mopping. Reliable liquid absorption. Highest quality of yarn. Resists mildew growth, extending mop life and white appearance.



BLEND SHRINKLESS®

General-purpose mopping. Pre-laundered for reduced shrinking. Longer-lasting and less linting compared to cotton. Highly absorbent/no break-in required.



SYNTHETIC BLEND

All-synthetic mop yarns resist abrasive floor surfaces.



BLEND

General-purpose mopping. Longer-lasting and less linting compared to cotton. Highly absorbent/no break-in required.



MAINTENANCE

Made of woven rayon/polyester fabric that will not fray or lint. For use in Class 10,000 and higher industrial applications.



COTTON

General-purpose mopping. Least expensive yarn option. Reliable liquid absorption. Requires break-in, dries slowly, may lint.



ROUGH-FLOOR

Knitted fleece cotton/polyester blend yarn for highly abrasive surfaces. High absorbency.



NON-WOVEN

General-purpose mopping. Least expensive wet mop option. Highly absorbent. Requires no break-in and delivers reduced linting versus cotton. Not launderable.

HEADBAND TYPE

Headbands drive mop handle selection and can be made of cloth or mesh. Mesh headbands dry faster and can sometimes be used as a scrubbing tool due to the abrasive nature of the material.



1" HEADBAND

Most optimal with side-gate Invader® Wet Mop Handle.



5" HEADBAND

Most optimal with clamp-style Gripper® Wet Mop Handle.



UNIVERSAL HEADBAND

Compatible with Gripper® and Invader® Wet Mop Handles.

TAILBAND TYPE

Tailbands prevent tangling and improve floor coverage for more efficient mopping. Not all mops have tailbands.



WOVEN TAILBAND

Allows for commercial laundering. Most expensive type of tailband.



YARN TAILBAND

Requires handwashing or limited residential laundering. Economical tailband choice.



NO TAILBAND

Requires handwashing only.

END TYPE

Mop ends can be looped or cut, and ultimately impact mop launderability, fraying, linting, and unraveling.



LOOPED END

Reduces fraying, linting, and unraveling. Allows for laundering, extending lifetime. Generally more expensive.



CUT END

Economical and practical general-purpose mop. Ends may fray and unravel. Does not incorporate tailband, covering less area. Disposable or hand wash.

REFERENCE GUIDE

Use the following guide to choose the best Rubbermaid Commercial Products Wet Mops for your facility.

DECORATIVE REFUSE

CLEANING

MATERIAL HANDLING

WASHROOM

FOODSERVICE

ACCESSORIES
& INDEX

		REFERENCE	PAGE #	FLOOR TYPE/APPLICATION		
				VINYL TILE, LAMINATE, SMOOTH CERAMIC TILE	ANTI-SLIP TILE, TERRAZZO, PAVER & QUARRY STONE	RUBBER, HARDWOOD, SMOOTH CONCRETE
GENERAL	BEST	Web Foot® Microfiber Tube Wet Mop	100	•	•	•
		Web Foot® Microfiber String Wet Mop	100	•	•	•
		Web Foot® Blend Shrinkless® Wet Mop	101	•	•	•
	BETTER	Maximizer™ Microfiber Blend Wet Mop	102	•	•	•
		Swinger Loop® Wet Mop	103	•	•	•
		Super Stitch® Blend Wet Mop	104	•	•	•
		Super Stitch® Cotton Wet Mop	104	•		•
		Universal Headband Blend Wet Mop	106	•	•	•
		Universal Headband Cotton Wet Mop	106	•		•
		Disposable Wet Mop	107	•		•
GOOD	Dura Pro Cut-End Blend Wet Mop	107	•		•	
	Dura Pro Cut-End Cotton Wet Mop	107	•		•	
	Value Pro Cut-End Cotton Wet Mop	108	•		•	

SPECIALTY	BEST	Web Foot® Finish Wet Mop	101	•		•
		Maintenance Wet Mop	109	•	•	•
		Rough-Floor Wet Mop	109	•	•	•
	BETTER	Super Stitch® Blend Finish Wet Mop	104	•	•	•
		Synthetic Blend Hot Wet Mop	104	•	•	•
		Universal Headband Rayon Finish Wet Mop	106	•	•	•
	GOOD	Value Pro Rayon Finish Wet Mop	108	•		•

MOP CONSTRUCTION				MOPPING ATTRIBUTES	
END TYPE	TAILBAND TYPE	YARN TYPE	HEADBAND SIZE	LAUNDERABILITY	SUSTAINABILITY
Looped	Woven	Microfiber	1", 5"	Up To 200 Commercial Launderings	No Recycled Content
Looped	Woven	Microfiber	5"	Up To 100 Commercial Launderings	Up to 27% Recycled Content
Looped	Woven	Blend	1", 5"	Up To 75 Commercial Launderings	Up to 45% Recycled Content
Looped	Woven	Blend	Universal	Up To 50 Commercial Launderings	Up to 15% Recycled Content
Looped	Woven	Blend	1", 5"	Up To 50 Commercial Launderings	Up to 100% Recycled Content
Looped	Yarn	Blend	1", 5"	Up To 50 Residential Launderings	Up to 100% Recycled Content
Looped	Yarn	Cotton	1", 5"	Up To 50 Residential Launderings	Up to 100% Recycled Content
Looped	Yarn	Blend	Universal	Up To 50 Residential Launderings	Up to 100% Recycled Content
Looped	Yarn	Cotton	Universal	Up To 50 Residential Launderings	Up to 100% Recycled Content
Cut	Non-Woven	Disposable	5"	0 Launderings; Single Use Disposable	Up to 99% Recycled Content
Cut	None	Blend	1"	Hand Wash Only	Up to 100% Recycled Content
Cut	None	Cotton	1"	Hand Wash Only	Up to 100% Recycled Content
Cut	None	Cotton	1"	Hand Wash Only	Up to 100% Recycled Content

Looped	Tapeless	Blend	1"	Up To 75 Commercial Launderings	Up to 45% Recycled Content
Looped	Woven	Blend	5"	Up To 75 Commercial Launderings	No Recycled Content
Looped	Woven	Blend	5"	Up To 75 Commercial Launderings	No Recycled Content
Looped	Yarn	Blend	1"	Up To 50 Residential Launderings	Up to 70% Recycled Content
Cut	None	Blend	5"	Hand Wash Only	Up to 70% Recycled Content
Looped	None	Rayon	Universal	Up To 50 Residential Launderings	Up to 75% Recycled Content
Cut	None	Rayon	1"	Hand Wash Only	Up to 75% Recycled Content

Web Foot® Mops

Web Foot® offers the best performance in the industry with maximum absorbency, ultimate durability, fast drying, and superior launderability.

- Looped ends and tailbands reduce tangling for like-new performance after every laundering
- Shrinkless® mops are prelaunched and preshrunk for longer product life
- Colorfast colors will not fade with repeated launderings
- Suitable for healthcare and general commercial maintenance applications
- Premium launderability

Web Foot® Microfiber Tube Mops

Designed to have greater floor contact and improved absorbency.

- Constructed with a blend of continuous-filament microfiber and polyester
- Superior absorbency and release characteristics
- Tube design reduces drag for increased productivity
- Recycled content: up to 50% PET Plastic
- Premium launderability, up to 200 launderings
- Double-stitched tailband improves durability and eliminates streaking
- PVC-coated mesh headband for longer product life



BLEACH-
SAFE
in hot & cold water



FOR MICROFIBER FLAT
MOPS, SEE PAGE 78.

NO.	COLOR	DESCRIPTION	U.S. HEADBAND SIZE	U.S. SHIP WT/CTN	MOP SIZE	METRIC HEADBAND SIZE	METRIC SHIP WT/CTN	PACK
FGT81206	GR00	Web Foot® Microfiber Tube Mop	1"	4.5 lb	Medium	2.5 cm	2.0 kg	6
FGT81306	GR00	Web Foot® Microfiber Tube Mop	1"	4.8 lb	Large	2.5 cm	2.2 kg	6
FGT85206	GR00	Web Foot® Microfiber Tube Mop	5"	4.5 lb	Medium	12.7 cm	2.0 kg	6
FGT85306	GR00	Web Foot® Microfiber Tube Mop	5"	4.8 lb	Large	12.7 cm	2.2 kg	6

Web Foot® Microfiber String Mops

- Highly durable and absorbent for extra-long life
- Premium launderability, up to 100 launderings
- PVC-coated mesh headband for longer product life
- Double-stitched tailband improves durability and eliminates streaking



NO.	COLOR	DESCRIPTION	U.S. HEADBAND SIZE	U.S. SHIP WT/CTN	MOP SIZE	METRIC HEADBAND SIZE	METRIC SHIP WT/CTN	HEADBAND COLOR	PACK
FGA85206	GR00	Web Foot® Microfiber String Mop	5"	6.0 lb	Medium	12.7 cm	2.7 kg	Green	6
FGA85306	GR00	Web Foot® Microfiber String Mop	5"	5.6 lb	Large	12.7 cm	2.6 kg	Green	6

* See page 99 for more information on recycled content

When ordering products with **BOLD** color codes, please specify color code after the product number. Refer to the Standard Color Guide at the back of the catalog.

Web Foot® Blend Shrinkless® Mops

- Balanced 4-ply blend of cotton and synthetic yarn is prelaundered
- Woven tailband provides more floor coverage
- PVC-coated mesh headband prohibits moisture penetration and resists chemicals
- Recycled content: up to 35% post-industrial cotton and 45% PET plastic
- Looped ends reduce fraying, linting, and unraveling
- Premium launderability, up to 75 launderings



FGA21206

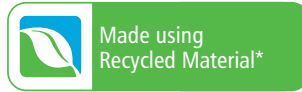

NO.	COLOR	DESCRIPTION	U.S. HEADBAND SIZE	U.S. SHIP WT/CTN	MOP SIZE	METRIC HEADBAND SIZE	METRIC SHIP WT/CTN	HEADBAND COLOR	PACK
FGA21206	GR00, WH00, BL00	Web Foot® Shrinkless® Wet Mop	1"	7.6 lb	Medium	2.5 cm	3.4 kg	GRN	6
FGA21306	WH00	Web Foot® Shrinkless® Wet Mop	1"	10.8 lb	Large	2.5 cm	4.9 kg	RED	6
FGA25206	GR00, WH00, BL00, OR00	Web Foot® Shrinkless® Wet Mop	5"	7.7 lb	Medium	12.7 cm	3.5 kg	GRN	6
FGA25306	GR00, WH00, BL00, OR00	Web Foot® Shrinkless® Wet Mop	5"	11.0 lb	Large	12.7 cm	5.0 kg	RED	6

Web Foot® Finish Mops

- Looped-end 4-ply synthetic yarn is designed for a controlled release of floor finish
- Tailband is sewn on the inside of mop and helps reduce the "drag" patterns common to most finish mops
- Recycled content: up to 70% PET plastic
- **Shipped as compact mop packages**
- Premium launderability, up to 75 launderings



FGA41206

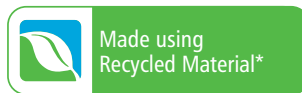

NO.	COLOR	DESCRIPTION	U.S. HEADBAND SIZE	U.S. SHIP WT/CTN	MOP SIZE	METRIC HEADBAND SIZE	METRIC SHIP WT/CTN	HEADBAND COLOR	PACK
FGA41206	WH00	Web Foot® Finish Mop	1"	6.0 lb	Medium	2.5 cm	2.7 kg	WHT	6
FGA41306	WH00	Web Foot® Finish Mop	1"	8.6 lb	Large	2.5 cm	3.9 kg	WHT	6

* See page 99 for more information on recycled content

Maximizer™ Microfiber Blend Mops

The Maximizer™ Microfiber Mop provides best cost of ownership and highest level of cleaning power.

- The specially designed tailband delivers 30% greater spread in use
- 25% less weight means less effort when mopping and lifting
- The unique Maximizer™ Blend delivers the highest absorbency ratio of any mop in its class
- Absorbs up to 3X as much as cotton
- Industry-leading durability – developed to withstand up to 100 commercial laundering cycles
- The universal headband is compatible with any traditional wet mop connection system and durable enough to withstand scrubbing applications



1924815

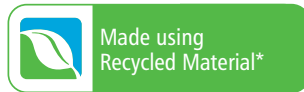

NO.	COLOR	DESCRIPTION	U.S. HEADBAND SIZE	U.S. SHIP WT/CTN	MOP SIZE	METRIC HEADBAND SIZE	METRIC SHIP WT/CTN	HEADBAND COLOR	PACK
1924815	GREEN	Maximizer™ Microfiber Mop	Universal	6.0 lb	Medium	Universal	2.7 kg	Black	6
1924817	RED	Maximizer™ Microfiber Mop	Universal	6.0 lb	Medium	Universal	2.7 kg	Black	6

* See page 99 for more information on recycled content



1924815 / FG758888BLUE / FGH14600BL00 / FG611200YEL

When ordering products with **BOLD** color codes, please specify color code after the product number. Refer to the Standard Color Guide at the back of the catalog.



FGC11306WH00 / 2031764 / FGH116000000

Swinger Loop® Wet Mops

Looped-end, tailbanded mop for better floor coverage.

- Balanced 4-ply blend of cotton and synthetic yarn for absorbency and strength
- Launderable for long product life
- Recycled content: colors are up to 65% post-industrial cotton blend and 35% PET plastic
- Shipped as compact mop packages
- Standard launderability, up to 50 launderings



FGC15306

Made using up to 100% Recycled Material.

NO.	COLOR	DESCRIPTION	U.S. HEADBAND SIZE	U.S. SHIP WT/CTN	MOP SIZE	METRIC HEADBAND SIZE	METRIC SHIP WT/CTN	HEADBAND COLOR	PACK
FGC11306	WH00, BL00	Swinger Loop® Wet Mop	1"	8.6 lb	Large	2.5 cm	3.9 kg	RED	6
FGC15206	BL00	Swinger Loop® Wet Mop	5"	6.0 lb	Medium	12.7 cm	2.7 kg	GRN	6
FGC15306	GR00, WH00, BL00	Swinger Loop® Wet Mop	5"	8.6 lb	Large	12.7 cm	3.9 kg	RED	6

Super Stitch® Blend Mops

Outperforms and outlasts premium cut-end mops 2 to 1.

- Balanced blend of cotton and synthetic yarns for absorbency and strength
- Looped ends and yarn tailband provide greater floor coverage
- Recycled content: colors are up to 65% post-industrial cotton and 35% PET plastic
- **Shipped as compact mop packages**
- Up to 50 residential launderings

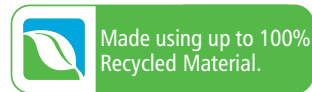

FGD25206

NO.	COLOR	DESCRIPTION	U.S. HEADBAND SIZE	U.S. SHIP WT/CTN	MOP SIZE	METRIC HEADBAND SIZE	METRIC SHIP WT/ CTN	HEADBAND COLOR	PACK
FGD21206	GR00*, RD00, WH00, BL00	Super Stitch® Blend Mop	1"	5.9 lb	Medium	2.5 cm	2.7 kg	WHITE	6
FGD21306	GR00, RD00, WH00*, BL00	Super Stitch® Blend Mop	1"	8.0 lb	Large	2.5 cm	3.6 kg	WHITE	6
FGD25206	GR00, RD00, WH00, BL00	Super Stitch® Blend Mop	5"	5.9 lb	Medium	12.7 cm	2.7 kg	WHITE	6
FGD25306	GR00, RD00, WH00, BL00	Super Stitch® Blend Mop	5"	8.0 lb	Large	12.7 cm	3.6 kg	WHITE	6

*Available in Bolt-On Headband 12-pack.

Super Stitch® Cotton Mops

Economical, general-purpose mop.

- Looped-end 4-ply yarn with yarn tailband for greater coverage with each stroke
- Recycled content: up to 100% post-industrial cotton/synthetic blend
- **Shipped as compact mop packages**
- Up to 50 residential launderings

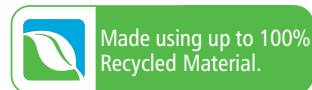

FGD11306

NO.	COLOR	DESCRIPTION	U.S. HEADBAND SIZE	U.S. SHIP WT/ CTN	MOP SIZE	METRIC HEADBAND SIZE	METRIC SHIP WT/ CTN	HEADBAND COLOR	PACK
FGD11306	WH00	Super Stitch® Cotton Looped-End Wet Mop	1"	7.6 lb	Large	2.5 cm	3.4 kg	WHITE	6
FGD11206	WH00	Super Stitch® Cotton Looped-End Wet Mop	1"	5.9 lb	Medium	2.5 cm	2.7 kg	WHITE	6
FGD15306	WH00	Super Stitch® Cotton Looped-End Wet Mop	5"	7.6 lb	Large	12.7 cm	3.4 kg	WHITE	6

Super Stitch® Finish Mops

Blend yarns for great absorbency and release.

- Bright blue and white yarn helps identify finish mop versus general-purpose mop
- Looped ends and yarn tailband help reduce streaking
- Tightly twisted, 4-ply polyester and rayon yarn helps reduce linting
- Recycled content: 70% PET plastic
- **Shipped as compact mop packages**
- Limited launderability, or hand wash up to 50 launderings



FGD51306

NO.	COLOR	DESCRIPTION	U.S. HEADBAND SIZE	U.S. SHIP WT/ CTN	MOP SIZE	METRIC HEADBAND SIZE	METRIC SHIP WT/ CTN	HEADBAND COLOR	PACK
FGD51306	WH00	Super Stitch® Finish Mop	1"	5.9 lb	Large	2.5 cm	2.7 kg	WHITE	6

* See page 99 for more information on recycled content



UTILITY REFUSE
AND RECYCLING

DECORATIVE REFUSE

CLEANING

MATERIAL HANDLING

WASHROOM

FOODSERVICE

ACCESSORIES
& INDEX

2025507 / FGH11600000 / FG611200YEL



Universal Headband Blend Mops

Cotton/synthetic yarn blend has almost twice the absorbency of cotton.

- Looped ends reduce fraying associated with cut-end mops
- Universal headband fits both side-loading and clamp-style handles
- Recycled content: up to 65% post-industrial cotton blend and 35% PET plastic
- Up to 50 residential launderings

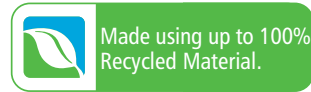

NO.	COLOR	DESCRIPTION	U.S. HEADBAND SIZE	U.S. SHIP WT/CTN	MOP SIZE	METRIC HEADBAND SIZE	METRIC SHIP WT/CTN	HEADBAND COLOR	PACK
FGE23800	BL00	Universal Headband Blue Blend Mop	Universal	19.0 lb	24 oz	0.7 kg	8.6 kg	WHITE	12

Universal Headband Rayon Mop

Ideal for floor finish application.

- Looped ends reduce linting and depling
- Universal headband fits both side-loading and clamp-style handles
- Recycled content: up to 75%
- Limited launderability, or hand wash up to 50 launderings



NO.	COLOR	DESCRIPTION	U.S. HEADBAND SIZE	U.S. SHIP WT/CTN	MOP SIZE	METRIC HEADBAND SIZE	METRIC SHIP WT/CTN	HEADBAND COLOR	PACK
FGE43800	WH00	Universal Headband Rayon Mop	Universal	19.0 lb	24 oz	0.7 kg	8.6 kg	WHITE	12

Universal Headband Cotton Mops

Excellent, all-purpose mop for general cleaning.

- Looped ends reduce fraying associated with cut-end mops
- Universal headband fits both side-loading and clamp-style handles
- Recycled content: up to 100% post-industrial cotton blend
- Limited launderability, or hand wash up to 50 launderings

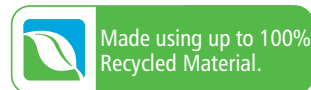

NO.	COLOR	DESCRIPTION	U.S. HEADBAND SIZE	U.S. SHIP WT/CTN	MOP SIZE	METRIC HEADBAND SIZE	METRIC SHIP WT/CTN	HEADBAND COLOR	PACK
FGE13800	WH00	Universal Headband Cotton Mop	Universal	18.0 lb	24 oz	0.7 kg	8.2 kg	WHITE	12

* See page 99 for more information on recycled content

When ordering products with **BOLD** color codes, please specify color code after the product number. Refer to the Standard Color Guide at the back of the catalog.

Disposable Wet Mops

The Disposable Mop from Rubbermaid Commercial Products helps workers reduce the spread of dirt and grime, resulting in cleaner floors. Engineered with hydrophilic, non-woven material, the RCP Disposable Mop is designed for one-time use to deliver a consistent clean shift after shift.

- Removes 3X more dirt and grease*
- No break-in period for immediate peak performance
- Reduced Quat binding**
- Reduced linting*
- Product made from 99% recycled material
- Tailband for maximum spread and consistent floor coverage
- Safe for floor stripping



2025506

NO.	COLOR	DESCRIPTION	U.S. HEADBAND SIZE	U.S. SHIP WT/CTN	U.S. MOP SIZE	METRIC HEADBAND SIZE	METRIC SHIP WT/CTN	HEADBAND COLOR	PACK
2025506	WH00	Disposable Wet Mop	5"	9.0 lb	#20	12.7 cm	4.1 kg	WHITE	24
2025507	WH00	Disposable Wet Mop	5"	10.6 lb	#24	12.7 cm	4.8 kg	WHITE	24

Dura Pro Blend Mops

Cut-end, 4-ply cotton/rayon/synthetic yarn blend for good performance and durability.

- Outlasts and outperforms cotton
- Excellent absorbency
- Recycled content: colors are up to 65% post-industrial cotton blend and 35% PET plastic
- Nonlaunderable, bucket wash/wring only



FGF51700BL00

NO.	COLOR	DESCRIPTION	U.S. HEADBAND SIZE	U.S. SHIP WT/CTN	U.S. MOP SIZE	METRIC HEADBAND SIZE	METRIC SHIP WT/CTN	METRIC MOP SIZE	HEADBAND COLOR	PACK
FGF51600	BL00	Premium Cut-End Blend Mop	1"	13.0 lb	16 oz	2.5 cm	5.9 kg	0.5 kg	WHITE	12
FGF51700	BL00	Premium Cut-End Blend Mop	1"	16.0 lb	20 oz	2.5 cm	7.3 kg	0.6 kg	WHITE	12
FGF51800	WH00, BL00	Premium Cut-End Blend Mop	1"	19.0 lb	24 oz	2.5 cm	8.6 kg	0.7 kg	WHITE	12

Dura Pro Cotton Mops

Economical, 4-ply cut-end mop for general-purpose cleaning.

- Absorbent 4-ply cotton for general-purpose mopping
- Recycled content: up to 100% post-industrial cotton/synthetic blend
- Shipped as compact mop packages
- Nonlaunderable, bucket wash/wring only



FGF11900

NO.	COLOR	DESCRIPTION	U.S. HEADBAND SIZE	U.S. SHIP WT/CTN	U.S. MOP SIZE	METRIC HEADBAND SIZE	METRIC SHIP WT/CTN	METRIC MOP SIZE	HEADBAND COLOR	PACK
FGF11600	WH00	Premium Cut-End Cotton Mop	1"	12.0 lb	16 oz	2.5 cm	5.4 kg	0.5 kg	WHITE	12
FGF11700	WH00	Premium Cut-End Cotton Mop	1"	15.0 lb	20 oz	2.5 cm	6.8 kg	0.6 kg	WHITE	12
FGF11800	WH00	Premium Cut-End Cotton Mop	1"	18.0 lb	24 oz	2.5 cm	8.2 kg	0.7 kg	WHITE	12
FGF11900	WH00	Premium Cut-End Cotton Mop	1"	24.0 lb	32 oz	2.5 cm	10.9 kg	0.9 kg	WHITE	12

* Versus RCP economy cotton mops.

** Versus used RCP economy cotton mops after 8-hour Quat exposure.

Value Pro Cut-End Cotton and Rayon Wet Mops

Cotton mop for general, all-purpose cleaning;
rayon mop for finish application

- Recycled content: up to 100%
- Actual weight may vary by 2 oz.
- Shipped as compact mop packages
- Nonlaunderable, bucket wash/wring only

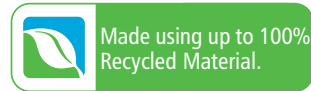

FGV11800

Value Pro Cotton Mops

NO.	COLOR	DESCRIPTION	U.S. HEADBAND SIZE	U.S. SHIP WT/ CTN	U.S. MOP SIZE	METRIC HEADBAND SIZE	METRIC SHIP WT/ CTN	METRIC MOP SIZE	HEADBAND COLOR	PACK
FGV11600	WH00	Economy Cotton Cut-End Mop	1"	10.1 lb	#16	2.5 cm	4.6 kg	N/A	WHITE	12
FGV11700	WH00	Economy Cotton Cut-End Mop	1"	13.1 lb	#20	2.5 cm	5.9 kg	N/A	WHITE	12
FGV11800	WH00	Economy Cotton Cut-End Mop	1"	15.8 lb	#24	2.5 cm	7.2 kg	N/A	WHITE	12
FGV11900	WH00	Economy Cotton Cut-End Mop	1"	21.0 lb	#32	2.5 cm	9.5 kg	N/A	WHITE	12

Value Pro Rayon Mops

NO.	COLOR	DESCRIPTION	U.S. HEADBAND SIZE	U.S. SHIP WT/ CTN	U.S. MOP SIZE	METRIC HEADBAND SIZE	METRIC SHIP WT/ CTN	METRIC MOP SIZE	HEADBAND COLOR	PACK
FGV41800	WH00	Economy Rayon Cut-End Mop	1"	18.0 lb	#24	2.5 cm	8.2 kg	N/A	WHITE	12
FGV41900	WH00	Economy Rayon Cut-End Mop	1"	23.0 lb	#32	2.5 cm	10.4 kg	N/A	WHITE	12

Synthetic Blend Mops

Economical, cut-end wet mop for general cleaning.

- All-synthetic mop yarn resists abrasive floor surfaces, such as quarry tile, for long-lasting performance
- Yarn blend absorbs 4 to 5 times the mop's weight
- Colors are perfect for a color-coding system and resist mop graying for long-lasting, like-new appearance
- Shipped as compact mop packages
- Recycled content: up to 70% post-consumer PET plastic
- Nonlaunderable, bucket wash/wring only

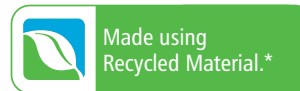

NO.	COLOR	DESCRIPTION	U.S. HEADBAND SIZE	U.S. SHIP WT/ CTN	U.S. MOP SIZE	METRIC HEADBAND SIZE	METRIC SHIP WT/ CTN	METRIC MOP SIZE	HEADBAND COLOR	PACK
FGF13700	GR00	Synthetic Blend Mop	5"	8.6 lb	24 oz	12.7 cm	3.9 kg	0.7 kg	WHITE	6

* See page 99 for more information on recycled content

When ordering products with **BOLD** color codes, please specify color code after the product number. Refer to the Standard Color Guide at the back of the catalog.

Maintenance Mops

Looped-end, tailbanded mop for greater floor coverage with each stroke.

- For use in Class 10,000 and higher industrial applications, such as paint booths and pharmaceutical labs
- Made of woven, rayon/polyester fabric that will not fray or lint
- Launderable and preshrunk for long product life
- Premium launderability, up to 75 launderings



NO.	COLOR	DESCRIPTION	U.S. HEADBAND SIZE	U.S. SHIP WT/ CTN	U.S. MOP SIZE	METRIC HEADBAND SIZE	METRIC SHIP WT/ CTN	METRIC MOP SIZE	HEADBAND COLOR	PACK
FGT30000	WH00	Maintenance Mop	5"	13.0 lb	16 oz	2.7 cm	5.9 kg	0.5 kg	GREEN	12

Rough-Floor Wet Mops

Economical choice for abrasive floor surfaces.

- Knitted fleece cotton/polyester blend yarn has twice the absorbency of cotton
- Excels on abrasive floor surfaces, such as nonslip/nonskid, stone, terrazzo, concrete, and other textured floor surfaces
- Looped ends and tailband aid in launderability
- Headband is compatible with Clamp-Style Wet Mop Handle
- Premium launderability, up to 75 launderings



FGT25600

NO.	COLOR	DESCRIPTION	U.S. HEADBAND SIZE	U.S. SHIP WT/ CTN	U.S. MOP SIZE	METRIC HEADBAND SIZE	METRIC SHIP WT/ CTN	METRIC MOP SIZE	HEADBAND COLOR	PACK
FGT25500	WH00	Rough-Floor Wet Mop	5"	12.0 lb	Medium	2.7 cm	5.4 kg	N/A	GREEN	12
FGT25600	WH00	Rough-Floor Wet Mop	5"	15.0 lb	Large	2.7 cm	6.8 kg	N/A	RED	12

Wet Mop Handles

Invader® and Gripper® Wet Mop Handles make removing and replacing mop heads easy and efficient.

- Invader® Side-Gate Handle's thumbwheel clamps the mop firmly in place; should be used with 1" headband mops
- Gripper® Clamp-Style Handles hold mop firmly between the jaws of the mop handle; should be used with 5" headband mops only
- Hardwood, Aluminum, and Fiberglass for all applications

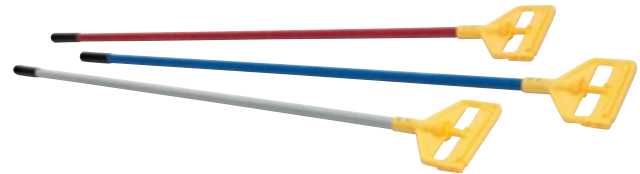
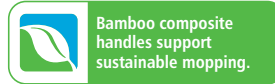

Invader® Side-Gate Handles

Invader® Side-Gate Style Wet Mop Handles

NO.	COLOR	DESCRIPTION	U.S. DIMENSIONS	U.S. SHIP WT/CTN	METRIC DIMENSIONS	METRIC SHIP WT/CTN	PACK
FGH11600	0000	Invader® Side-Gate Wet Mop Handle, Large Yellow Plastic Head, Hardwood Handle	60.0" l	15.0 lb	152.4 cm	6.8 kg	12
FGH12600	0000	Invader® Side-Gate Wet Mop Handle, Large Yellow Plastic Head, Gray Aluminum Handle	60.0" l	12.0 lb	152.4 cm	5.4 kg	12
FGH13600	0000	Invader® Side-Gate Wet Mop Handle, Large Yellow Plastic Head, Vinyl-Covered Aluminum Handle	60.0" l	17.0 lb	152.4 cm	7.7 kg	12
FGH14500	0000	Invader® Side-Gate Wet Mop Handle, Large Yellow Plastic Head, Fiberglass Handle	54.0" l	15.0 lb	137.2 cm	6.8 kg	12
FGH14600	GY00, RD00, BL00	Invader® Side-Gate Wet Mop Handle, Large Yellow Plastic Head, Fiberglass Handle	60.0" l	17.0 lb	152.4 cm	7.7 kg	12
FGH51600	0000	Easy-Change Wet Mop Handle, Large Steel Head, Wood Handle	1.1" dia x 60.0" l	31.0 lb	2.9 cm dia x 152.4 cm	14.1 kg	12



Gripper® Clamp-Style Handles

Gripper® Clamp-Style Wet Mop Handles

NO.	COLOR	DESCRIPTION	U.S. DIMENSIONS	U.S. SHIP WT/CTN	METRIC DIMENSIONS	METRIC SHIP WT/CTN	PACK
FGH21600	0000	Gripper® Clamp-Style Wet Mop Handle, Plastic Yellow Head, Hardwood Handle	60.0" l	15.0 lb	152.4 cm	6.8 kg	12
FGH22600	0000	Gripper® Clamp-Style Wet Mop Handle, Plastic Yellow Head, Gray Aluminum Handle	60.0" l	12.0 lb	152.4 cm	5.4 kg	12
FGH23600	0000	Gripper® Clamp-Style Wet Mop Handle, Plastic Yellow Head, Vinyl-Coated Aluminum Handle	60.0" l	17.0 lb	152.4 cm	7.7 kg	12
FGH24500	0000	Gripper® Clamp-Style Wet Mop Handle, Plastic Yellow Head, Fiberglass Handle	54.0" l	15.0 lb	137.2 cm	6.8 kg	12
FGH24600	GY00, BL00	Gripper® Clamp-Style Wet Mop Handle, Plastic Yellow Head, Fiberglass Handle	60.0" l	17.0 lb	152.4 cm	7.7 kg	12

BRUTE® Buckets

Heavy-duty thick-walled construction.

- BRUTE® buckets have molded-in graduations for accurate measuring
- Corrosion-resistant bails with comfortable plastic grip



FG261400



FG296300

NO.	COLOR	DESCRIPTION	U.S. DIMENSIONS	U.S. CAPACITY	U.S. SHIP WT/CTN	METRIC DIMENSIONS	METRIC CAPACITY	METRIC SHIP WT/CTN	PACK
FG261400	RED, GRAY	Round Bucket	12.0" dia x 11.3" h	14.0 qt	10.7 lb	30.5 cm dia x 28.6 cm	13.2 L	4.9 kg	6
FG296300	RED, GRAY	Round Bucket	10.5" dia x 10.3" h	10.0 qt	14.3 lb	26.7 cm dia x 26.0 cm	9.5 L	6.5 kg	12

Pail and Mop Strainer Combination

Lightweight design helps increase operator productivity.

- Lightweight combo pack lets operator travel up and down stairs easily
- Pail holds up to 15 quarts (14.2 L); strainer wrings mops up to 10 ounces
- Durable plastic construction has smooth, easy-to-clean surface
- Pails and funnel-shaped mop strainers nest and stack for convenient transport and storage between jobs



NO.	COLOR	DESCRIPTION	U.S. DIMENSIONS	U.S. CAPACITY	U.S. SHIP WT/CTN	METRIC DIMENSIONS	METRIC CAPACITY	METRIC SHIP WT/CTN	PACK
FG619400	STL	Pail and Mop Strainer Combination	17.0" l x 10.5" w x 12.0" h	15 qt	14.9 lb	43.2 cm x 26.7 cm x 30.5 cm	14.2 L	6.8 kg	6

Steel Sponge Mop/Double Pails

An easy-to-use cleaning system.

- Front-pull lever on mop handle for squeeze-action wringing (FG643500)
- Cellulose sponge mop head absorbs liquids fast
- Double pail for separation of cleaning solution and rinse water



FG262888



FG643500

NO.	COLOR	DESCRIPTION	U.S. DIMENSIONS	U.S. CAPACITY	U.S. SHIP WT/CTN	METRIC DIMENSIONS	METRIC CAPACITY	METRIC SHIP WT/CTN	PACK
FG261700	GRAY	Double Pail	14.6" l x 13.9" w x 10.1" h	17 qt	18.1 lb	37.2 cm x 35.3 cm x 25.7 cm	16.1 L	8.2 kg	6
FG262888	GRAY	Double Pail	18.0" l x 14.5" w x 10.0" h	19 qt	21.1 lb	45.7 cm x 36.8 cm x 25.4 cm	18.0 L	9.6 kg	6
FG643500	BRNZ	Steel Sponge Mop with Cellulose Head	12.4" l x 3.4" w x 50.5" h	N/A	14.9 lb	31.5 cm x 8.6 cm x 128.3 cm	N/A	6.8 kg	6
FG643600	YEL	Steel Cellulose Replacement Head	12.0" l x 3.0" w x 7.5" h	N/A	8.4 lb	30.5 cm x 7.6 cm x 19.1 cm	N/A	3.8 kg	12

UTILITY REFUSE AND RECYCLING

DECORATIVE REFUSE

CLEANING

MATERIAL HANDLING

WASHROOM

FOODSERVICE

ACCESSORIES & INDEX



FGQ41800GR00 / FGQ56000YL00 / FGQ74500YL00

Dust Mopping

There are several important factors to consider when choosing a dust mop. Use the guidelines on the following pages to choose the best dust mop for your floor care needs.

General Dust Mopping

Choose mops with high-dust pickup and durability. If laundering is available, launderable mops will be the most economical choice. Microfiber looped-end and twisted-loop mop heads with reinforced stitching and slip-on/slide-off backing offer the best performance and launderability.

Mop Construction Features



Twisted-Loops

Highly effective at capturing dust and dirt. Premium Twisted-Loops are less prone to snags, frays, and unraveling during cleaning and laundering.

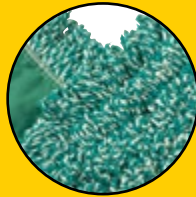

Looped Ends

Reduce fraying and depleting for better durability and longer product life. More effective than cut-end mops.



Cut Ends

Economical construction for general-purpose dusting.



Reinforced Stitching

Reinforced, double-needle stitching at key "wear" points increases product life.



Backing Design

Slip-on/slide-off backing allows quick, easy setup or breakdown for standard mop frames.

Launderability

The launderability of a mop is based on the number of commercial washing and drying cycles it can withstand before the construction of the mop is degraded or the performance declines. Microfiber, synthetic, and blended fiber mops have the highest levels of launderability.

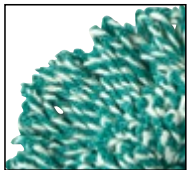

MICROFIBER



BLEND



SYNTHETIC

Durability

The durability of a mop is a measure of how long it will perform before needing to be replaced. Microfiber, synthetic, and blended fiber mops are the most durable.

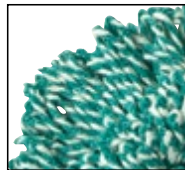

MICROFIBER



BLEND



SYNTHETIC

Dust Pickup

Dust pickup is the ability of a mop to remove dust and dirt from the floor surface. Microfiber, blended fiber, and synthetic mops have the highest degree of dust pickup.

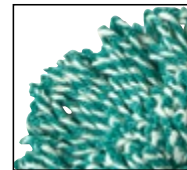

MICROFIBER



BLEND



SYNTHETIC

Dust Mop Selection Guide

Use the following guide to choose the best Rubbermaid Commercial Products Dust Mops for your facility.



Look for this symbol to find dust mops made with recycled fibers.



ENVIRONMENT	BEST	BETTER	GOOD
HEALTHCARE FACILITIES	HYGEN™ Microfiber Dust Mops, Microfiber Looped-End Dust Mop, Twisted-Loop	Trapper®	Kut-A-Way®
EDUCATIONAL FACILITIES	HYGEN™ Microfiber Dust Mops Microfiber Looped-End Dust Mop, Twisted-Loop	Kut-A-Way®	Cut-to-Length
INDUSTRIAL AND COMMERCIAL	HYGEN™ Microfiber Dust Mops, Microfiber Looped-End Dust Mop, Trapper®	Kut-A-Way®	Disposable Cut-End Blended
FOODSERVICE	HYGEN™ Microfiber Dust Mops, Microfiber Looped-End Dust Mop, Twisted-Loop	Kut-A-Way®	Disposable Cut-End Blended
OFFICE BUILDINGS	HYGEN™ Microfiber Dust Mops, Microfiber Looped-End Dust Mop, Twisted-Loop	Kut-A-Way®	Disposable Cut-End Blended
HOSPITALITY	HYGEN™ Microfiber Dust Mops, Microfiber Looped-End Dust Mop, Twisted-Loop	Kut-A-Way®	Disposable Cut-End Blended

HYGEN™ Microfiber Dust Mops

Capture and remove more dirt and dust.

HYGEN™ Microfiber Dust Mops remove up to 80% more dust and dirt than traditional cotton dust mops. Durable up to 500 launderings (200 with bleach). Certified to tolerate CDC hot and cold water laundering requirements.

*see page 78 for more details

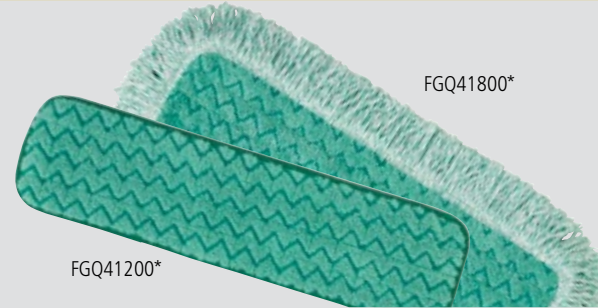

Microfiber Looped-End Dust Mops

Featuring the cleaning power of microfiber combined with famous high-quality Rubbermaid construction.

- Constructed with a blend of continuous-filament microfiber and traditional spun staple mop yarn
- Withstands twice the laundry cycles of traditional dust mops
- Works with all traditional dust mop handles and frames
- Recycled content: up to 28% post-industrial cotton and 42% PET plastic



Made using Recycled Material.*

NO.	MOP COLOR	DESCRIPTION	U.S. SHIP WT/CTN	U.S. MOP SIZE	METRIC SHIP WT/CTN	METRIC MOP SIZE	PACK
FGJ85300	GR00	Microfiber Loop Dust Mop 24"	11.7 lb	24.0" l x 5.0" w	5.3 kg	61.0 cm x 12.7 cm	12
FGJ85500	GR00	Microfiber Loop Dust Mop 36"	15.0 lb	36.0" l x 5.0" w	6.8 kg	91.4 cm x 12.7 cm	12
FGJ85700	GR00	Microfiber Loop Dust Mop 48"	18.7 lb	48.0" l x 5.0" w	8.5 kg	121.9 cm x 12.7 cm	12
FGE05200	WH00	Microfiber Finish Loop Dust Mop 18"	5.0 lb	18.0" l x 5.0" w	2.3 kg	45.7 cm x 12.7 cm	6

* Made using up to 70% recycled content

When ordering products with **BOLD** color codes, please specify color code after the product number. Refer to the Standard Color Guide at the back of the catalog.

Twisted-Loop Dust Mops

Premium prelauded dust mops provide maximum durability and optimal cleaning performance. Twisted loops create fuller mop heads with no gaps, offering better coverage than traditional ply yarn and improved collection and retention of dust and dirt particles.

- Less prone to snagging, fraying, and unraveling
- Slip-on backing for easy setup
- Durable polyester backing designed for launderable printing that will not launder out
- **Handles sold separately;** see *Dust Mop Frames and Handles*



FGJ35300

Synthetic

NO.	COLOR	DESCRIPTION	U.S. SHIP WT/CTN	U.S. MOP SIZE	METRIC SHIP WT/CTN	METRIC MOP SIZE	PACK
FGJ35300	BL00	Twisted-Loop Synthetic Dust Mop 24"	12.4 lb	24.0" l x 5.0" w	5.6 kg	61.0 cm x 12.7 cm	12
FGJ35500	BL00	Twisted-Loop Synthetic Dust Mop 36"	17.7 lb	36.0" l x 5.0" w	8.0 kg	91.4 cm x 12.7 cm	12

Blended

NO.	COLOR	DESCRIPTION	U.S. SHIP WT/CTN	U.S. MOP SIZE	METRIC SHIP WT/CTN	METRIC MOP SIZE	PACK
FGJ25300	BL00	Twisted-Loop Blend Dust Mop 24"	12.4 lb	24.0" l x 5.0" w	5.6 kg	61.0 cm x 12.7 cm	12
FGJ25500	BL00	Twisted-Loop Blend Dust Mop 36"	17.7 lb	36.0" l x 5.0" w	8.0 kg	91.4 cm x 12.7 cm	12
FGJ25700	BL00	Twisted-Loop Blend Dust Mop 48"	22.4 lb	48.0" l x 5.0" w	10.2 kg	121.9 cm x 12.7 cm	12

Trapper® Dust Mops

Looped-end, balanced-blend dust mop for general-purpose dust mopping.

- Pretreated and fully launderable for long product life
- Slip-on backing for easy setup
- All-sewn construction
- Recycled content: up to 65% post-industrial cotton blend and 35% PET plastic



FGJ15700

NO.	COLOR	DESCRIPTION	U.S. SHIP WT/CTN	U.S. MOP SIZE	METRIC SHIP WT/CTN	METRIC MOP SIZE	PACK
FGJ15300	YL00	Trapper® Dust Mop 24"	11.0 lb	24.0" l x 5.0" w	5.0 kg	61.0 cm x 12.7 cm	12
FGJ15700	YL00	Trapper® Dust Mop 48"	21.0 lb	48.0" l x 5.0" w	9.5 kg	121.9 cm x 12.7 cm	12

Kut-A-Way® Dust Mops

Cut-end mop excellent for general-purpose dust mopping.

- Prelauded
- Launderable for long product life
- Envelope-end backing style
- All sewn construction
- Recycled content: colors are up to 65% post-industrial cotton blend and 35% PET plastic; white is up to 100% post-industrial cotton blend



FGK15300

NO.	COLOR	DESCRIPTION	U.S. SHIP WT/CTN	U.S. MOP SIZE	METRIC SHIP WT/CTN	METRIC MOP SIZE	PACK
FGK15300	WH00, BL00	Kut-A-Way® Dust Mop 24"	11.0 lb	24.0" l x 5.0" w	5.0 kg	61.0 cm x 12.7 cm	12
FGK15500	WH00, BL00	Kut-A-Way® Dust Mop 36"	16.0 lb	36.0" l x 5.0" w	7.3 kg	91.4 cm x 12.7 cm	12

Disposable Cut-End Blended Dust Mops

Soft, open-twist blended cut-end yarn for increased dust pickup.

- Pretreated and mops up to 500,000 sq ft (46,450 m²) before needing replacement
- Envelope-end backing style and durable Typar® backing
- Recycled content: up to 65% post-industrial cotton blend and 35% PET plastic



FGL15300

NO.	COLOR	DESCRIPTION	U.S. SHIP WT/CTN	U.S. MOP SIZE	METRIC SHIP WT/CTN	METRIC MOP SIZE	PACK
FGL15300	GROO, WH00	Blended Cut-End Disposable Dust Mop 24"	9.0 lb	24.0" l x 5.0" w	4.1 kg	61.0 cm x 12.7 cm	12

Disposable Cut-End Cotton Dust Mops

Economical cotton cut-end dust mop.

- Pretreated, with envelope-end backing style
- Recycled content: up to 100%

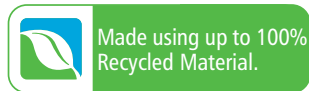

FGL25500

NO.	COLOR	DESCRIPTION	U.S. SHIP WT/CTN	U.S. MOP SIZE	METRIC SHIP WT/CTN	METRIC MOP SIZE	PACK
FGL25300	WH00	Cut-End Disposable Cotton Dust Mop 24"	9.0 lb	24.0" l x 5.0" w	4.1 kg	61.0 cm x 12.7 cm	12
FGL25500	WH00	Cut-End Disposable Cotton Dust Mop 36"	13.0 lb	36.0" l x 5.0" w	5.9 kg	91.4 cm x 12.7 cm	12

Snap-On Wire Dust Mop Frames

Corrosion-resistant, powder-coated, heavy-duty metal frame for durable performance.



FGM253000000



NO.	COLOR	DESCRIPTION	U.S. DIMENSIONS	U.S. SHIP WT/CTN	METRIC DIMENSIONS	METRIC SHIP WT/CTN	PACK
FGM25300	0000	Snap-On Wire Dust Mop Frame 24"	24.0" l x 5.0" w	14.0 lb	61.0 cm x 12.7 cm	6.4 kg	12
FGM25500	0000	Snap-On Wire Dust Mop Frame 36"	36.0" l x 5.0" w	18.0 lb	91.4 cm x 12.7 cm	8.2 kg	12
FGM25700	0000	Snap-On Wire Dust Mop Frame 48"	48.0" l x 5.0" w	22.0 lb	121.9 cm x 12.7 cm	10.0 kg	12

Snap-On Dust Mop Handles

Available in easily sanitized, vinyl-covered wood, fiberglass, or hardwood handles.

- Spring-loaded clip easily attaches to the Snap-On Dust Mop Frame
- Sliding collar locks the handle into position or swivels a full 360°



FGM11600

NO.	COLOR	DESCRIPTION	U.S. DIMENSIONS	U.S. SHIP WT/CTN	METRIC DIMENSIONS	METRIC SHIP WT/CTN	PACK
FGM11600	0000	Snap-On Dust Mop Handle, Hardwood	60.0" l	26.0 lb	152.4 cm	11.8 kg	12
FGM14600	0000	Snap-On Dust Mop Handle, Fiberglass	60.0" l	24.0 lb	152.4 cm	10.9 kg	12

When ordering products with **BOLD** color codes, please specify color code after the product number. Refer to the Standard Color Guide at the back of the catalog.

Cut-to-Length Dust Mop

Cuts floor cleaning costs down to size.

- Continuous 40' (12.2 m) roll yields 20% savings over conventional dust mops
- Cut-to-length convenience lets you customize your mop to fit any standard mop frame
- Untreated, cut-end 4-ply cotton yarn provides excellent dust pickup; durable Typar® backing for long life
- Slip-on backing for easy setup
- Recycled content: up to 100% post-industrial cotton blend

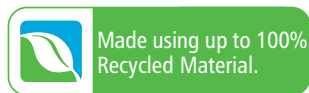

NO.	COLOR	DESCRIPTION	U.S. DIMENSIONS	U.S. CARTON DIMENSIONS	U.S. SHIP WT/CTN	METRIC DIMENSIONS	METRIC CARTON DIMENSIONS	METRIC SHIP WT/CTN	PACK
FGM15000	WH00	Cut-to-Length Dust Mop	40.0" l x 5.0" w	18.3" l x 11.8" w x 12.6" h	13.0 lb	101.6 cm x 12.7 cm	46.4 cm x 29.8 cm x 32.1 cm	5.9 kg	1

HYGEN™ QUICK-CONNECT FLEXI WAND WITH MICROFIBER DUSTING SLEEVE

HYGEN™ Microfiber Quick-Connect Flexi-Wand and Duster helps remove dust from crevices and hard-to-reach places. The duster frame conforms to the shape of the surface being cleaned for optimal surface contact and easily clean vents, furniture, bed covers, uniquely shaped fixtures, and more. Thorough dust removal is critical to preventing the spread of infection and sustaining a clean environment.

Features and Benefits: Easily bends and conforms to irregular shapes to allow users to clean crown molding, tops of cabinets, and other areas; Quick-Connect Handle allows Flexi-Wand to be used with any of our telescoping handles; Washable duster sleeve slides on and off for easy replacement; Bleach Safe; Certified to tolerate CDC hot and cold water laundering requirements

*see page 84 for more details

FGQ85200



Overhead Dusting Tools

A sensible solution to routine overhead dusting.

- Heads are launderable for long product life
- Telescoping handle allows simple and efficient overhead use

Lambswool Duster

Fast, effective surface dusting.

- 100% lambswool duster
- Ideal for dusting large areas quickly and effectively



NO.	COLOR	DESCRIPTION	U.S. SHIP WT/CTN	METRIC SHIP WT/CTN	PACK
FGT11000	GY00	Overhead Dusting Tool with Launderable Head, 51" l (129.5 cm) Extension Handle	8.0 lb	3.6 kg	12
FGT12000	GY00	Overhead Dusting Tool with Angled Launderable Head, 51" l (129.5 cm) Extension Handle	8.0 lb	3.6 kg	12
FGT19900	WH00	Overhead Dusting Tool Replacement Head fits FGT11000, FGT12000	4.0 lb	1.8 kg	12
FG9C0400	0000	30"-42" (76.2 cm-106.6 cm) Lambswool Duster with Telescoping Plastic Handle	1.8 lb	0.8 kg	6

Carpet Bonnets

Use with a standard rotary floor machine for interim carpet maintenance.

- The low-profile bonnet provides improved operator control on rotary floor machines from 175 to 300 RPM



FGP26900

NO.	COLOR	DESCRIPTION	U.S. DIMENSIONS	U.S. SHIP WT/CTN	METRIC DIMENSIONS	METRIC SHIP WT/CTN	PACK
FGP26900	WH00	Low-Profile with Green Scrub Strips Bonnet	19.0" dia	9.0 lb	48.3 cm dia	4.1 kg	5



BROOM CONSTRUCTION

DEFINED

BROOM CONSTRUCTION

Using a state of the art production process in Lumberton, NC, RCP push brooms feature advanced injection molding, computer-optimized bristle stapling and full-scale push broom assembly to ensure consistent, durable, high quality brooms that stand up to the most demanding commercial jobs.

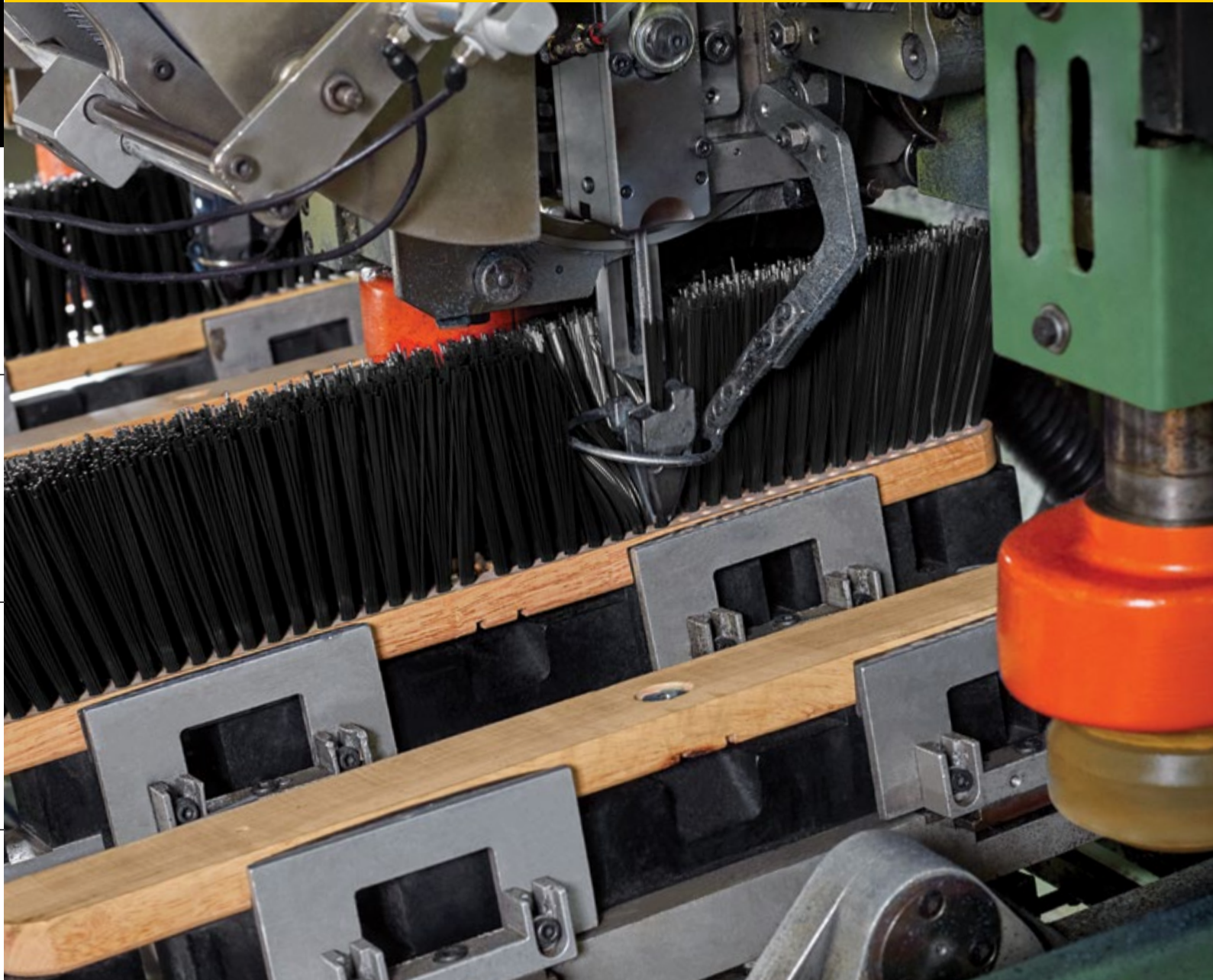



MEDIUM POLYPROPYLENE

Medium-weight, durable fiber made to sweep debris on medium to rough surfaces.



POLYETHYLENE (PET)

Soft, durable material used to sweep fine debris on smooth surfaces.

Assembled Push Brooms

- Up to 40% more bristles for efficient debris removal
- Fully assembled, permanent steel brace and die-cast aluminum connector for durability
- Choose from Fine Polyethylene (PET) or Multi-Surface/Medium Polypropylene
- Handles and heads sold together



2040044

NO.	DESCRIPTION	BRISTLE TYPE	BRISTLE U.S. SIZES	HANDLE	BLOCK	BRACE	METRIC SIZES	PACK
2040049	36" Fine Polypropylene	Fine Pet	3"	1.1" Wood	Wood	Steel	7.6 cm	4
2040044	36" Medium Polypropylene Assembled	Medium Pp	3"	1.1" Wood	Wood	Steel	7.6 cm	4

MAXIMIZER™ Push-to-Center Brooms

- Angled sides capture more debris per stroke*
- Durable polypropylene bristles can be used on smooth and rough surfaces, effectively sweeping different debris types
- PVC bristles remove fine dirt and debris on smooth, polished surfaces
- Polypropylene foam block resists cracking, splitting, warping and rotting
- Heads and handles sold together



NO.	COLOR	DESCRIPTION	U.S. DIMENSIONS	U.S. SHIP WT/CTN	METRIC DIMENSIONS	METRIC SHIP WT/CTN	PACK
2018727	BLACK	Maximizer™ Push-To-Center Broom – 18" MP	19.3" l x 6.8" w x 63.5" h	2.5 lb	49.0 cm x 17.3 cm x 161.3 cm	1.1 kg	6
2186280	BLACK	Maximizer™ Push-To-Center Broom – 24" MP	24.8" l x 6.3" w x 62.4" h	2.5 lb	63.0 cm x 16.0 cm x 158.5 cm	1.1 kg	6
2018728	BLACK	Maximizer™ Push-To-Center Broom – 36" MP	37.4" l x 7.5" w x 64.1" h	3.3 lb	95.0 cm x 19.0 cm x 162.8 cm	1.5 kg	6

*vs. standard RCP push brooms

Broom Handles

Available in threaded or tapered tips.

- Available in wood or lightweight aluminum

FG636100



FG636200



FG635700



FG636400

**Threaded**

NO.	COLOR	DESCRIPTION	U.S. DIMENSIONS	U.S. SHIP WT/CTN	METRIC DIMENSIONS	METRIC SHIP WT/CTN	PACK
FG635700	BLA	Super Self-Locking Wood Handle, Threaded Metal Tip	1.1" dia x 60.0" l	13.7 lb	2.7 cm dia x 152.4 cm	6.2 kg	12
FG636100	LAC	Wood Handle, Threaded, Lacquered	1.1" dia x 60.0" l	13.4 lb	2.7 cm dia x 152.4 cm	6.1 kg	12
FG636400	LAC	Wood Handle, Threaded Metal Tip, Lacquered	1.1" dia x 60.0" l	13.0 lb	2.7 cm dia x 152.4 cm	5.9 kg	12

Tapered

NO.	COLOR	DESCRIPTION	U.S. DIMENSIONS	U.S. SHIP WT/CTN	METRIC DIMENSIONS	METRIC SHIP WT/CTN	PACK
FG636200	NAT	Wood Handle, Tapered, Sanded	1.1" dia x 60.0" l	16.1 lb	2.9 cm dia x 152.4 cm	7.3 kg	12

When ordering products with **BOLD** color codes, please specify color code after the product number. Refer to the Standard Color Guide at the back of the catalog.

Angle Brooms

Ideal for cleaning hard-to-reach areas.

- Cut and shaped for easy sweeping
- Long-lasting, stain-resistant polypropylene bristles
- Permanent fusion-set bristles won't pull out



NO.	COLOR	DESCRIPTION	SWEEP FACE	U.S. SHIP WT/CTN	METRIC SHIP WT/CTN	PACK
FG637500	GRAY	Broom, 1" dia (2.5 cm) Vinyl-Coated Metal Handle, Flagged Polypropylene Fill	10.5"	10.2 lb	4.6 kg	6
FG638500	GRAY	Broom, 1" dia (2.5 cm) Metal Handle, Flagged Polypropylene Fill	10.5"	9.6 lb	4.4 kg	6
FG638906	BLA	Jumbo Smooth Sweep Angle Broom, 1 1/4" dia (4.76 cm) Black Metal Handle, Polypropylene Fill	10.0"	26.5 lb	12.0 kg	6

Corn Broom

Designed for rugged indoor/outdoor cleaning.

- 100% natural broom corn fibers for long life and effective pickup
- Remove fine dirt from even or rough surfaces
- Hand-selected, heavy-duty lacquered pine handles



NO.	THREAD COLOR	DESCRIPTION	SWEEP FACE	U.S. SIZES	U.S. SHIP WT/CTN	METRIC SIZES	METRIC SHIP WT/CTN	PACK
FG638300	BLUE	Corn Broom, Warehouse, 1.13" dia (2.9 cm) Stained/Lacquered Handle	12.0"	31.0 lb	30.0 lb	14.1 kg	13.6 kg	12

Lobby Pro® Upright Dust Pans

Stylish pan design.

- Durable rear wheels improve wear resistance and extend product life
- Self-opening and closing lid on FG253200 conceals unsightly dirt and debris
- Bracket and brooms sold separately



NO.	COLOR	DESCRIPTION	U.S. DIMENSIONS	U.S. SHIP WT/CTN	METRIC DIMENSIONS	METRIC SHIP WT/CTN	PACK
FG253100	BLA	Executive Lobby Pro® Dust Pan, Long Handle	12.8" l x 11.3" w x 5.0" h	13.0 lb	32.5 cm x 28.7 cm x 12.7 cm	5.9 kg	6
FG253200	BLA	Executive Lobby Pro® Dust Pan with Cover, Long Handle	12.8" l x 11.3" w x 5.0" h	13.0 lb	32.5 cm x 28.7 cm x 12.7 cm	5.9 kg	6
FG253600	BLA	Executive Lobby Broom w/ Wood Handle	7.0" l x 37.5" h	2.0 lb	17.8 cm x 95.3 cm	0.9 kg	12
FG637300	BRN	Lobby Broom, 100% Corn Fill	8.0" l x 1.5" w x 38.0" h	10.0 lb	20.3 cm x 3.8 cm x 96.5 cm	4.5 kg	12
FG637400	BLA	Executive Lobby Broom w/ Vinyl Handle	7.5" l x 2.0" w x 35.0" h	6.6 lb	19.1 cm x 5.1 cm x 88.9 cm	3.0 kg	6
FG253120	BLA	Lobby Pro Upright Dust Pan	11.4" l x 12.8" w x 5.4" h	8.3 lb	28.9 cm x 32.5 cm x 13.7 cm	3.8 kg	4

BRUSH CONSTRUCTION GUIDE

FILL—SYNTHETIC

DECORATIVE REFUSE



POLYSTYRENE

Extremely durable. Excellent bristle bend recovery and shear/break strength. Resistant to water, oils, and solvents. Not for sweeping compounds or oily surfaces.

CLEANING



POLYPROPYLENE

Very durable with good abrasion resistance and shear/break strength. Will not stain, discolor, or absorb odors. Resistant to solvents, acids, oils, fungus, and bacteria growth. Can be used wet or dry.

MATERIAL HANDLING

WASHROOM

Plastic-Handle Utility Brushes

Durable synthetic brushes.

- All-plastic structural foam blocks have hang-up hole for easy storage
- Available in synthetic
- Ideal for foodservice applications and institutional use



FOODSERVICE

NO.	BRISTLE COLOR	DESCRIPTION	TRIM LENGTH	U.S. DIMENSIONS	U.S. SHIP WT/CTN	METRIC DIMENSIONS	METRIC SHIP WT/CTN	PACK
FG9B2900	YEL	Short Plastic-Handle Utility Brush, Synthetic Fill	2.0"	8.0" l x 3.1" w x 3.1" h	3.3 lb	20.3 cm x 7.9 cm x 7.9 cm	1.5 kg	6

When ordering products with **BOLD** color codes, please specify color code after the product number. Refer to the Standard Color Guide at the back of the catalog.

Floor/Deck Scrub Brush

Plastic blocks resist splitting and delaminating.

- Flagged synthetic fibers help avoid scratching
- Long-lasting, stain-resistant polypropylene bristles
- Accepts threaded handles



NO.	BRISTLE COLOR	DESCRIPTION	ACCEPTED HANDLE	TRIM LENGTH	U.S. DIMENSIONS	U.S. SHIP WT/CTN	METRIC DIMENSIONS	METRIC SHIP WT/CTN	PACK
FG633700	BLUE	Floor Scrub, Plastic Block, Bi-level, Polypropylene Fill	Threaded	2.0"	10.0" l x 6.3" w x 3.5" h	7.5 lb	25.4 cm x 16.0 cm x 8.9 cm	3.4 kg	6

Scrub Brushes

Natural and synthetic fibers set in plastic block.

- Designed to make scrubbing tile and grout lines and cleaning floors, baseboards, walls, and countertops easier



FG9B5600



FG648200

NO.	COLOR	DESCRIPTION	TRIM LENGTH	U.S. DIMENSIONS	U.S. SHIP WT/CTN	METRIC DIMENSIONS	METRIC SHIP WT/CTN	PACK
FG648200	COBLT	Iron Handle Scrub Brush, Polypropylene Fill	1.0"	6.0" l x 2.3" w x 2.3" h	3.4 lb	15.2 cm x 5.8 cm x 5.8 cm	1.5 kg	12
FG9B5600	BLA	Tile and Grout Brush, Polypropylene Bristles	0.8"	8.9" l x 5.8" w x 2.6" h	0.8 lb	22.6 cm x 14.7 cm x 6.6 cm	0.4 kg	12

Toilet Bowl Brushes and Holders

Available in several handle lengths, head sizes and styles.

- Polypropylene and crimped polypropylene fills
- Stain- and odor-resistant



FG631000 /
FG631100



FG632000

NO.	COLOR	DESCRIPTION	TRIM LENGTH	U.S. DIMENSIONS	U.S. SHIP WT/CTN	METRIC DIMENSIONS	METRIC SHIP WT/CTN	PACK
FG631000	WHT	Toilet Bowl Brush, Plastic Handle, Polypropylene Fill	1.1"	14.4" l x 3.4" w x 3.4" h	7.0 lb	36.6 cm x 8.6 cm x 8.6 cm	3.2 kg	24
FG631100	WHT	Toilet Bowl Brush Holder, fits FG631000 Brush	N/A	5.0" l x 5.0" w x 3.9" h	6.5 lb	12.7 cm x 12.7 cm x 9.9 cm	2.9 kg	24
FG632000	BRN	Toilet Bowl Brush, Plastic Handle, Polypropylene Fill	1.5"	16.8" l x 4.1" w x 4.1" h	6.0 lb	42.7 cm x 10.4 cm x 10.4 cm	2.7 kg	12

Wall Washer Kit

Pivoting head for smooth, even control.

- Raised-ribbed design works with either side-press or down-press mop wringers without requiring additional adapters
- Washable pads remove easily for laundering



FGS22600

NO.	COLOR	DESCRIPTION	U.S. DIMENSIONS	U.S. SHIP WT/CTN	METRIC DIMENSIONS	METRIC SHIP WT/CTN	PACK
FGS22600	GY00	Wall Washer Kit Includes 1 Aluminum Handle, 1 Plastic Head, 2 Cotton Pads	60.0" l x 7.5" w x 2.0" h	2.5 lb	152.4 cm x 19.1 cm x 5.1 cm	1.1 kg	1
FGS29900	WH00	Wall Washer Replacement Pads, Launderable Cotton	9.0" l x 5.0" w	8.0 lb	22.9 cm x 12.7 cm	3.6 kg	12

Counter Brushes/Whisk Broom/Heavy-Duty Dust Pans

Perfect for quick cleanups.

- Counter brushes feature structural foam blocks with polypropylene fills
- Heavy-duty plastic dust pans come in an extra-large size to hold ample amounts of dirt and debris



FG200500



FG9B5500



FG634200

NO.	COLOR	DESCRIPTION	SWEEP FACE	U.S. DIMENSIONS	U.S. SHIP WT/CTN	METRIC DIMENSIONS	METRIC SHIP WT/CTN	PACK
FG634200	SILV	Plastic Block Counter Brush, Flagged Polypropylene Fill with 8" (20.3 cm) Bristle Coverage	8.0"	2.0' l x 12.5" w x 4.0" h	3.0 lb	5.1 cm x 31.8 cm x 10.2 cm	1.4 kg	6
FG9B5500	YEL	Corn Whisk Broom	N/A	12.5" l x 5.5" w x 1.0" h	5.0 lb	31.8 cm x 14.0 cm x 2.5 cm	2.3 kg	12
FG200500	CHAR	Heavy-Duty Dust Pan	N/A	12.5" l x 8.3" w x 13.3" h	6.2 lb	31.8 cm x 21.0 cm x 33.8 cm	2.8 kg	12

When ordering products with **BOLD** color codes, please specify color code after the product number. Refer to the Standard Color Guide at the back of the catalog.

Floor Squeegees

Dual Moss Squeegees

- Nonmarking, flexible blades are ideal for uneven surfaces
- Leaves floors virtually dry to the touch, ideal for spills
- For use in removing liquids and light dirt
- *Handles sold separately*



Traditional Squeegees

- Galvanized metal frame and locking strip
- Fit standard 1 1/8" tapered handles
- Nonmarking 2" black rubber blades
- For removing liquids and heavy dirt
- *Handles sold separately*

Dual Moss Squeegees

NO.	COLOR	DESCRIPTION	U.S. DIMENSIONS	U.S. SHIP WT/CTN	METRIC DIMENSIONS	METRIC SHIP WT/CTN	PACK
FG9C2700*	BLA	22" (55.9 cm) Standard Floor Squeegee	22.0" l x 3.0" w x 4.5" h	6.6 lb	55.9 cm x 7.6 cm x 11.4 cm	3.0 kg	10
FG9C2800*	BLA	22" (55.9 cm) Heavy-Duty Floor Squeegee	22.0" l x 3.3" w x 5.5" h	13.6 lb	55.9 cm x 8.3 cm x 14.0 cm	6.2 kg	10
FG9C2900*	BLA	30" (76.2 cm) Heavy-Duty Floor Squeegee	30.0" l x 3.3" w x 5.5" h	15.8 lb	76.2 cm x 8.3 cm x 14.0 cm	7.2 kg	10

*Use with tapered or wood handles; see page 120.

Traditional Squeegees

NO.	COLOR	DESCRIPTION	U.S. DIMENSIONS	U.S. SHIP WT/CTN	METRIC DIMENSIONS	METRIC SHIP WT/CTN	PACK
FG9C3200*	BLA	24" (61 cm) Straight Floor Squeegee	24.0" l x 4.0" w x 6.8" h	13.7 lb	61.0 cm x 10.2 cm x 17.3 cm	6.2 kg	6
FG9C3400*	BLA	24" (61 cm) Curved Floor Squeegee	23.5" l x 4.0" w x 6.8" h	13.7 lb	59.7 cm x 10.2 cm x 17.3 cm	6.2 kg	6

*Use with tapered or wood handles; see page 120.

MAXIMIZER™ Wet/Dry Debris Pan

- Holds 10X More Liquid* for efficient clean up and less rework
- The wide opening allows liquid and solid debris to easily collect in the pan
- Molded-in baffles keep both dry and wet debris from leaking back onto floors
- Holds up to 32oz of liquid
- Comes with convenient Hanger Bracket to hold handles

MAXIMIZER™ Heavy Duty Debris Pan

- Extra large opening is wide enough to fit an 18" push broom
- Huge storage capacity reduces trips to empty the pan
- Locking latch for secure lifting and emptying of heavy loads up to 25 lbs
- Angled, ergonomic handle for reduced strain when sweeping debris into pan
- Durable rear wheels improve wear resistance and extend product life
- Molded comfort handle reduces strain
- Built-in hang hole for convenient storage



NO.	COLOR	DESCRIPTION	U.S. DIMENSIONS	U.S. SHIP WT/CTN	METRIC DIMENSIONS	METRIC SHIP WT/CTN	PACK
2018806	BLACK	Maximizer™ Wet/Dry Debris Pan	29.0" l x 16.9" w x 12.0" h	24.0 lb	73.7 cm x 42.9 cm x 30.5 cm	10.9 kg	6
2018781	BLACK	Maximizer™ Heavy-Duty Stand Up Debris Pan	29.0" l x 20.4" w x 11.0" h	39.6 lb	73.7 cm x 51.8 cm x 27.9 cm	18.0 kg	6



MOTORIZED

HOUSEKEEPING CART

MOVE HEAVY LOADS

WITH LESS EFFORT

Workers' compensation data from California shows that hotel housekeepers are ~2x as likely to experience an injury from pushing & pulling tasks relative to all other occupations.*

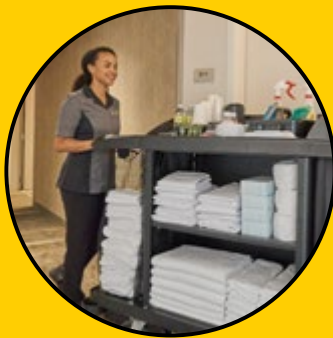

REDUCE STRAIN

The battery-powered cart virtually eliminates the need for manual force when transporting heavy loads in both forward and reverse.



REDUCE DOWNTIME

Facility custodians and housekeepers can complete an average shift using one fully-charged battery.**

Dual onboard battery compartments provide back-up power without having to plug in the entire cart and truck, minimizing costly workflow disruptions due to battery switch outs.



MAXIMIZE VERSATILITY

The retrofit motorized kits are compatible with new and existing RCP housekeeping carts***, providing a range of options to meet facility needs.

*"Workplace Injuries in Hotel Housekeeping in California" – Department of Industrial Relations (2016)

**Based on an average shift of 8 hours; assumes cart is not continuously running. Continuous runtime is approximately 2 hours.

***Compatible carts include FG6189/90/91/92, FG9T1900, 1969596

Executive Traditional Housekeeping Carts

A complete system solution for housekeeping in the hospitality industry.

- Durable commercial-grade construction
- Easy-to-clean surfaces and molded-in color
- Durable nonmarking 8" ball bearing casters allow for easy maneuverability
- Standard equipment includes fabric bag, bumpers, vacuum holder, and under-deck shelf
- Available with or without doors or hood
- Full-size cabinet offers exceptional storage space and adjustable middle shelf, add additional shelves for greater organization
- Fully-rounded, user-friendly handles are easy to grip and assist maneuverability
- Optional accessories enhance functionality and productivity
- Impact-absorbing and non-marring bumpers are designed to reduce costly wall damage



EXECUTIVE
SERIES™

EASY TO MAINTAIN
using genuine Rubbermaid
Commercial parts. See
Component Parts.

FG619100BLA



SECURE DOORS

Keep supplies concealed for discreet front-of-house appearance.

MESH FABRIC LINEN BAG

Allows quick and easy access to linens.



PROTECTIVE HOOD

Helps hide amenities and cleaning supplies from guests.

FG9T1900BLA

MULTIPLE FABRIC BAG OPTIONS

Rubbermaid offers a variety of fabric bags that allow the user to order the bags that will best fit their needs.



FG619200BLA

NO.	COLOR	DESCRIPTION	U.S. DIMENSIONS	U.S. SHIP WT/CTN	METRIC DIMENSIONS	METRIC SHIP WT/CTN	PACK
⑤ FG618900	BLA	Executive Full-Size Housekeeping Cart – Traditional*	60.0" l x 22.0" w x 50.0" h	102.1 lb	152.4 cm x 55.9 cm x 127.0 cm	46.3 kg	1
⑤ FG619000	BLA	Executive Compact Housekeeping Cart – Traditional*	49.0" l x 22.0" w x 50.0" h	95.6 lb	124.5 cm x 55.9 cm x 127.0 cm	43.4 kg	1
⑤ FG619100	BLA	Executive Full-Size Housekeeping Cart with Doors – Traditional*	60.0" l x 22.0" w x 50.0" h	108.8 lb	152.4 cm x 55.9 cm x 127.0 cm	49.4 kg	1
⑤ FG619200	BLA	Executive Compact Housekeeping Cart with Doors – Traditional* ¹	49.0" l x 22.0" w x 50.0" h	102.3 lb	124.5 cm x 55.9 cm x 127.0 cm	46.4 kg	1
⑤ FG9T1900	BLA	Executive Full-Size Housekeeping Cart with Doors and Hood – Traditional*	60.0" l x 22.0" w x 67.5" h	126.3 lb	152.4 cm x 55.9 cm x 171.5 cm	57.3 kg	1
⑤ 1969596	PLATINUM	Executive Full-Size Housekeeping Cart – Traditional*	60.0" l x 22.0" w x 50.0" h	102.1 lb	152.4 cm x 55.9 cm x 127.0 cm	46.3 kg	1

*Compatible with the Housekeeping Cart Retrofit Motorized Kit

¹Vacuum cannot be stored on the cart where the motorized kit is assembled

When ordering products with **BOLD** color codes, please specify color code after the product number. Refer to the Standard Color Guide at the back of the catalog.

Executive Compact Housekeeping Cart

Ergonomic and lightweight housekeeping solution.

- High capacity-to-footprint ratio; only 22" wide
- Multiple accessories available for a customized solution
- Includes locking security hood and cabinet doors, with access from both sides of cart
- 32% more compact size than our FG9T1900BLA Cart with Doors and Hood
- Includes two heavy-duty zippered fabric bags with vinyl lining



EASY TO MAINTAIN
using genuine Rubbermaid
Commercial parts.
See *Component Parts*.



FG9T7800BLA shown with optional FG9T9000BLA 9-Pocket Hanging Fabric Organizer and 1966889 side load mesh linen bag.

NO.	COLOR	DESCRIPTION	U.S. DIMENSIONS	U.S. SHIP WT/CTN	METRIC DIMENSIONS	METRIC SHIP WT/CTN	PACK
FG9T7800	BLA	Executive Housekeeping Compact Cart – High-Security	51.8" l x 22.0" w x 53.5" h	79.0 lb	131.4 cm x 55.9 cm x 135.9 cm	35.8 kg	1

Motorized Kit and Accessories

The motorized housekeeping cart kit moves heavy loads with less effort.

- Kit includes: hand-activated control, 2 motorized drive wheels, 1 battery, 1 charger, and 2 keys. Cart not included
- Compatible with compact and full-size Housekeeping carts (FG6189/90/91/92, FG9T1900, 1969596) — sold separately



NO.	COLOR	DESCRIPTION	U.S. DIMENSIONS	U.S. SHIP WT/CTN	METRIC DIMENSIONS	METRIC SHIP WT/CTN	PACK
2173556	BLACK	Housekeeping Cart Motorized Kit ¹	24.4" l x 17.3" w x 10.0" h	33.1 lb	62 cm x 44 cm x 25.5 cm	15.0 kg	1
2173520	BLACK	Motorized Kit Charger	6.6" l x 2.9" w x 8.9" h	1.9 lb	16.9 cm x 7.3 cm x 22.6 cm	0.9 kg	1
2173664	BLACK	Motorized Kit Universal Battery	5.0" l x 3.8" w x 4.8" h	4.6 lb	12.8 cm x 9.7 cm x 12.2 cm	2.1 kg	1

¹Includes one 60V battery, one 3Ah charger. Housekeeping Cart and additional battery sold separately.

Housekeeping Cart Bumper Kits

Impact-absorbing and non-marring bumpers are designed to reduce costly wall damage.

- Kits include four commercial-grade bumpers, wire vacuum rack, hardware, and assembly instructions
- Bumpers can be retrofitted to Traditional Full-Size or Compact housekeeping carts



2067692

NO.	COLOR	DESCRIPTION	U.S. DIMENSIONS	U.S. SHIP WT/CTN	METRIC DIMENSIONS	METRIC SHIP WT/CTN	PACK
2067692	BLACK	Bumper Kit for Full Size Housekeeping Carts	23.5" l x 19.0" w x 3.3" h	6.7 lb	59.6 cm x 48.2 cm x 8.3 cm	3.0 kg	1

UTILITY REFUSE AND RECYCLING

DECORATIVE REFUSE

CLEANING

MATERIAL HANDLING

WASHROOM

FOODSERVICE

ACCESSORIES & INDEX



Housekeeping Cart Accessories

• Bags are compatible with all housekeeping carts

30-GAL. HOUSEKEEPING
CART CANVAS BAG –
HIGH-CAPACITY



1966887

30-GAL. HOUSEKEEPING CART
CANVAS VINYL-LINED BAG –
HIGH-CAPACITY



1966888

EXECUTIVE 9-POCKET FABRIC
HANGING ORGANIZER



FG9T9000BLA

EXECUTIVE SIDE-LOAD
MESH LINEN BAG



1966889

EXECUTIVE 34-GAL.
JANITORIAL CLEANING CART
VINYL BAG – HIGH-CAPACITY



1966886

Bags

NO.	COLOR	DESCRIPTION	U.S. DIMENSIONS	U.S. SHIP WT/CTN	METRIC DIMENSIONS	METRIC SHIP WT/CTN	PACK
1966887	BROWN	30-Gal. Housekeeping Cart Canvas Bag – High-Capacity	16.8" l x 10.5" w x 33.0" h	17.3 lb	42.6 cm x 26.6 cm x 83.8 cm	7.9 kg	4
1966888	BLACK	Executive 30-Gal. Housekeeping Cart Canvas Vinyl-Lined Bag – High Capacity	16.8" l x 10.5" w x 33.0" h	17.3 lb	42.6 cm x 26.6 cm x 83.8 cm	7.9 kg	4
FG9T9000	BLA	Executive 9-Pocket Fabric Hanging Organizer	28.0" l x 19.8" w x 1.5" h	7.3 lb	71.1 cm x 50.2 cm x 3.8 cm	3.3 kg	6
1966889	BLACK	Executive Side-Load Mesh Linen Bag	16.8" l x 10.5" w x 33.0" h	6.4 lb	42.6 cm x 26.6 cm x 83.8 cm	2.9 kg	4
1966886	BLACK	Executive 34-Gal. Janitorial Cleaning Cart Vinyl Bag – High-Capacity	16.8" l x 10.5" w x 33.0" h	10.8 lb	42.6 cm x 26.6 cm x 83.8 cm	4.9 kg	4

When ordering products with **BOLD** color codes, please specify color code after the product number. Refer to the Standard Color Guide at the back of the catalog.

Traditional Housekeeping Cart Accessories

EXECUTIVE LOCKING DOOR KIT FOR TRADITIONAL HOUSEKEEPING CARTS



FG619700BLA

EXECUTIVE PROTECTIVE SECURITY HOOD FOR TRADITIONAL HOUSEKEEPING CARTS



FG9T0000BLA

EXECUTIVE DIVIDED CARRY CADDY, BLACK



1880994

EXECUTIVE ADJUSTABLE SHELF KIT FOR TRADITIONAL HOUSEKEEPING CARTS



FG619500BLA



EXECUTIVE SERIES™

Accessories

NO.	COLOR	DESCRIPTION	U.S. DIMENSIONS	U.S. SHIP WT/CTN	METRIC DIMENSIONS	METRIC SHIP WT/CTN	PACK
⑤ FG619700	BLA	Executive Locking Door Kit for Traditional Housekeeping Carts	34.0" l x 1.9" w x 31.6" h	6.7 lb	86.4 cm x 4.8 cm x 80.3 cm	3.0 kg	1
⑤ FG9T0000	BLA	Executive Protective Security Hood for Traditional Housekeeping Carts	31.6" l x 20.4" w x 17.5" h	21.5 lb	80.3 cm x 51.8 cm x 44.5 cm	9.8 kg	1
⑤ 1880994	BLACK	Executive Divided Carry Caddy	15.3" l x 10.8" w x 6.5" h	7.2 lb	38.7 cm x 27.3 cm x 16.5 cm	3.3 kg	6
⑤ FG619500	BLA	Executive Adjustable Shelf Kit for Traditional Housekeeping Carts	30.1" l x 18.5" w x 2.25" h	7.1 lb	76.5 cm x 47.0 cm x 5.7 cm	3.2 kg	1

UTILITY REFUSE AND RECYCLING

DECORATIVE REFUSE

CLEANING

MATERIAL HANDLING

WASHROOM

FOODSERVICE

ACCESSORIES & INDEX

Executive Quick Carts

The industry's most durable mobile cart solution that empowers staff to maintain areas discreetly and efficiently.

- Provide a premium guest experience, keeping the cleaning process hidden from view of guests
- Easily move throughout the property with a lightweight, compact, and durable construction
- Deliver a flexible solution, customizable for the unique needs of your property



EXECUTIVE
SERIES™



1902465 / 1902468



Repels Water, Oil, and Stains

Teflon™ fabric protector helps maintain Quick Cart aesthetics and protects from rigorous daily use.



Secured Stick Goods

Heavy-duty fastening strap wraps around supplies to keep them secure while the cart is in motion.



Secure Supplies

Durable lid conceals supplies and features hardware for adding a lock to prevent unauthorized access to cart and its contents.



Heavy-Duty Kick Plate

Reinforced rubberized kick plate for increased durability and reduced wear and tear.

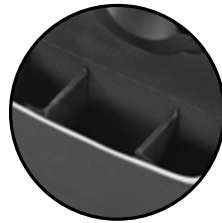

Adjustable Dividers

Dividers can be moved or removed to create multiple compartments to meet your specific cleaning needs.



1902465



Removable Carry Caddy

Rigid dividers improve efficiency, keeping amenities and supplies organized.

Teflon™ is a registered trademark of Chemours used under license by Rubbermaid Commercial Products LLC.

When ordering products with **BOLD** color codes, please specify color code after the product number. Refer to the Standard Color Guide at the back of the catalog.

Executive Quick Cart – Large

- 60-lb capacity
- 3.55 ft³ of total volume capacity
- High-performance polyester for increased durability
- 6 outer pockets (including 1 plastic lined pocket) and 6 inner pockets
- Pockets, caddy, and main compartment include adjustable dividers
- Large removable caddy included
- Removable inner liner for easy cleaning or replacement



EXECUTIVE SERIES™



1919270



1902701



1902468

NO.	COLOR	DESCRIPTION	U.S. DIMENSIONS	U.S. CAPACITY	U.S. SHIP WT/CTN	METRIC DIMENSIONS	METRIC CAPACITY	METRIC SHIP WT/CTN	PACK
⑤ 1902465	DARK GRAY	Executive Quick Cart – Large	16.5" L x 14.3" W x 25.0" H	3.4 ft³	21.0 lb	41.9 cm L x 36.2 cm W x 63.5 cm H	0.09 m³	9.5 kg	1
⑤ 1902468**	DARK GRAY	Executive Quick Cart Caddy – Large	14.0" L x 11.0" W x 5.5" H	0.5 ft³	5.1 lb	35.6 cm L x 27.9 cm W x 14.0 cm H	0.01 m³	2.3 kg	2
⑤ 1902701	BLACK	Executive Quick Cart Liner – Large	16.0" L x 12.8" W x 22.3" H	N/A	3.1 lb	40.6 cm L x 32.4 cm W x 56.5 cm H	N/A	1.4 kg	6
⑤ 1919270*	CLEAR	Executive Quick Cart Plastic Pocket Liner	3.8" L x 4.0" W x 8.5" H	N/A	0.7 lb	26.7 cm L x 27.9 cm W x 14.0 cm H	N/A	0.3 kg	4

*Replacement for all Executive Quick Carts.

**Replacement for Medium and Large Executive Quick Carts.

Executive Quick Cart – Medium

- 40-lb capacity
- 3.07 ft³ of total volume capacity
- High-performance polyester for increased durability
- 6 outer pockets (including 1 plastic lined pocket) and 6 inner pockets
- Pockets, caddy, and main compartment include adjustable dividers
- Large removable caddy included
- Removable inner liner for easy cleaning or replacement



EXECUTIVE SERIES™



1919270



1902702



1902468

NO.	COLOR	DESCRIPTION	U.S. DIMENSIONS	U.S. CAPACITY	U.S. SHIP WT/CTN	METRIC DIMENSIONS	METRIC CAPACITY	METRIC SHIP WT/CTN	PACK
⑤ 1902466	DARK GRAY	Executive Quick Cart – Medium	16.5" L x 14.3" W x 21.0" H	2.9 ft³	19.2 lb	41.9 cm L x 36.2 cm W x 53.3 cm H	0.08 m³	8.7 kg	1
⑤ 1902468**	DARK GRAY	Executive Quick Cart Caddy – Large	14.0" L x 11.0" W x 5.5" H	0.5 ft³	5.1 lb	35.6 cm L x 27.9 cm W x 14.0 cm H	0.01 m³	2.3 kg	2
⑤ 1902702	BLACK	Executive Quick Cart Liner – Medium	16.0" L x 12.8" W x 18.5" H	N/A	2.8 lb	40.6 cm L x 32.4 cm W x 47.0 cm H	N/A	1.3 kg	6
⑤ 1919270*	CLEAR	Executive Quick Cart Plastic Pocket Liner	3.8" L x 4.0" W x 8.5" H	N/A	0.7 lb	26.7 cm L x 27.9 cm W x 14.0 cm H	N/A	0.3 kg	4

*Replacement for all Executive Quick Carts.

**Replacement for Medium and Large Executive Quick Carts.

Executive Quick Cart – Small

- 30-lb capacity
- 2.80 ft³ of total volume capacity
- 5 outer pockets and 6 inner pockets
- High-performance polyester for increased durability
- Pockets, caddy, and main compartment include adjustable dividers
- Small removable caddy included
- Removable inner liner for easy cleaning or replacement



EXECUTIVE SERIES™



1919270

NO.	COLOR	DESCRIPTION	U.S. DIMENSIONS	U.S. CAPACITY	U.S. SHIP WT/CTN	METRIC DIMENSIONS	METRIC CAPACITY	METRIC SHIP WT/CTN	PACK
⑤ 1902467	DARK GRAY	Executive Quick Cart – Small	16.5" L x 14.3" W x 17.0" H	2.3 ft³	17.2 lb	41.9 cm L x 36.2 cm W x 43.2 cm H	0.07 m³	7.8 kg	1
⑤ 1919270*	CLEAR	Executive Quick Cart Plastic Pocket Liner	3.8" L x 4.0" W x 8.5" H	N/A	0.7 lb	26.7 cm L x 27.9 cm W x 14.0 cm H	N/A	0.3 kg	4

*Replacement for all Executive Quick Carts.

UTILITY REFUSE AND RECYCLING

DECORATIVE REFUSE

CLEANING

MATERIAL HANDLING

WASHROOM

FOODSERVICE

ACCESSORIES & INDEX

High-Security Janitorial Cleaning Carts

The foundation of a complete cleaning system for your facility.

- Locking hood and doors secure unattended carts and keep supplies concealed
- 7.25 cubic-foot storage capacity offers 40% more space than traditional carts to save time retrieving supplies
- Locking hood and doors support compliance with The Joint Commission Environment of Care® Standards
- Folding platform fits HYGEN™ Charging Bucket (FGQ95088YEL, sold separately) to create an integrated microfiber cleaning system
- Durable 8" wheels and quiet 4" casters make maneuverability easy and quiet (FG9T7500BLA/1861427)



WASTE COVER AND STORAGE COMPARTMENT

Provides waste coverage and offers functional storage for small items.

LOCKING HOOD
Ensures secure storage for critical items



1861427



FG9T7500BLA

NO.	COLOR	DESCRIPTION	U.S. DIMENSIONS	U.S. SHIP WT/CTN	METRIC DIMENSIONS	METRIC SHIP WT/CTN	PACK
FG9T7500	BLA	Janitorial Cleaning Cart – High-Security	48.3" l x 22.0" w x 53.5" h	70.0 lb	122.6 cm x 55.9 cm x 135.9 cm	31.8 kg	1
1861427	BLACK	Executive Janitorial Cleaning Cart – High-Security	48.3" l x 22.0" w x 53.5" h	70.0 lb	122.6 cm x 55.9 cm x 135.9 cm	31.8 kg	1

High-Capacity Janitorial Cleaning Carts with Bins

Multifunctional systems that are great for microfiber or standard cleaning.

- Flexible and configurable to fit your ever-changing cleaning needs
- 30-Qt removable bins offer organization and the ability to pre-stock supplies
- Mop bucket platform with securing grooves keeps WaveBrake® or HYGEN™ microfiber charging buckets in place
- Available components vary in color, size, and function to fit your specific needs (see *Cleaning Cart Accessories*)



FG9T7400BLA



FG9T7300BLA

NO.	COLOR	DESCRIPTION	U.S. DIMENSIONS	U.S. SHIP WT/CTN	METRIC DIMENSIONS	METRIC SHIP WT/CTN	PACK
FG9T7300	BLA	Janitorial Cleaning Cart w/Bins – High-Capacity	48.3" l x 22.0" w x 44.0" h	53.0 lb	122.6 cm x 55.9 cm x 111.8 cm	24 kg	1
FG9T7400	BLA	Janitorial Cleaning Cart Full Swivel w/Bins – High-Capacity	48.3" l x 22.0" w x 44.0" h	53.0 lb	122.6 cm x 55.9 cm x 111.8 cm	24 kg	1

When ordering products with **BOLD** color codes, please specify color code after the product number. Refer to the Standard Color Guide at the back of the catalog.

High-Capacity Janitorial Cleaning Cart

Flexible, high-capacity storage solutions and tool organization.

- 7.25 cubic-foot storage capacity offers 40% more space than traditional carts to save time retrieving supplies
- Rubber tool grips securely hold up to 5 stick goods
- Comfort Grip cart handle for easy maneuverability
- Hooks securely hold up to 4 safety signs
- Available components vary in color, size, and function to fit your specific needs (see *Cleaning Cart Accessories*)



NO.	COLOR	DESCRIPTION	U.S. DIMENSIONS	U.S. SHIP WT/CTN	METRIC DIMENSIONS	METRIC SHIP WT/CTN	PACK
FG9T7200	BLA	Janitorial Cleaning Cart – High-Capacity	48.3" l x 22.0" w x 44.0" h	45.0 lb	122.6 cm x 55.9 cm x 111.8 cm	20.4 kg	1

Traditional Janitorial Cleaning Carts

Collect waste and transport tools for efficient cleaning.

- Durable 8" wheels and 4" casters provide smooth and easy maneuverability (1861430/FG617388BLA)
- Front-access zippered bag allows user to easily remove collected waste with no need to lift through the top
- Front platform holds WaveBrake® mop bucket or up to a 32-gallon BRUTE® container
- Add optional Locking Cabinet Doors and Waste Covers (see *Cleaning Cart Accessories*)



ADD LOCKING CABINET DOORS

Help keep cleaning supplies hidden and secure.



FG617388BLA

EXECUTIVE SERIES™
1861430

NO.	COLOR	DESCRIPTION	U.S. DIMENSIONS	U.S. SHIP WT/CTN	METRIC DIMENSIONS	METRIC SHIP WT/CTN	PACK
FG617388	BLA, BLUE	Janitorial Cleaning Cart – Traditional	46.0" l x 21.8" w x 38.4" h	49.5 lb	116.8 cm x 55.2 cm x 97.5 cm	22.5 kg	1
1861430	BLACK	Executive Janitorial Cleaning Cart – Traditional	46.0" l x 21.8" w x 38.4" h	49.5 lb	116.8 cm x 55.2 cm x 97.5 cm	22.5 kg	1
1966719	YELLOW	24-Gal. Janitorial Cleaning Cart Vinyl Bag – Traditional	9.1" l x 6.5" w x 17.3" h	6.3 lb	23.2 cm x 16.5 cm x 43.8 cm	2.9 kg	4
1966720	BLACK	Executive 24-Gal. Janitorial Cleaning Cart Vinyl Bag – Traditional	9.1" l x 6.5" w x 17.3" h	5.6 lb	23.2 cm x 16.5 cm x 43.8 cm	2.6 kg	4
FG618100	YEL	Janitorial Cleaning Cart Locking Door Kit - Traditional	20.0" l x 16.0" w x 11.3" h	7.8 lb	50.8 cm x 40.6 cm x 28.6 cm	3.6 kg	1
1861443	BLACK	Executive Janitorial Cleaning Cart Locking Door Kit – Traditional	20.0" l x 16.0" w x 11.3" h	7.8 lb	50.8 cm x 40.6 cm x 28.6 cm	3.6 kg	1

Cleaning Cart Accessories

Improve workflow and increase productivity.

DECORATIVE REFUSE

24-GAL. JANITORIAL CLEANING CART VINYL BAG - TRADITIONAL



1966719

EXECUTIVE 34-GAL. JANITORIAL CLEANING CART VINYL BAG - HIGH-CAPACITY



1966886

34-GAL. JANITORIAL CLEANING CART VINYL BAGS - HIGH-CAPACITY



1966882, 1966883

EXECUTIVE TRIPLE WASTE WIRE BAG DIVIDER



FG9T89010000

CLEANING

EXECUTIVE 10-QT. HEAVY-DUTY CADDIES



FG9T8200BLA

5-QT. PAILS



FG9T8301

30-QT. ORGANIZING BINS



FG9T8400YEL

EXECUTIVE 9-POCKET FABRIC HANGING ORGANIZER



FG9T9000BLA

MATERIAL HANDLING

Bags and Bag Holders

NO.	COLOR	DESCRIPTION	U.S. DIMENSIONS	U.S. SHIP WT/CTN	METRIC DIMENSIONS	METRIC SHIP WT/CTN	PACK
1966881	YELLOW	34-Gal. Janitorial Cleaning Cart Vinyl Bag – High-Capacity	16.8" l x 10.5" w x 33.0" h	13.0 lb	42.6 cm x 26.6 cm x 83.8 cm	5.9 kg	4
⑤ 1966888	BLACK	Executive 30-Gal. Housekeeping Cart Canvas Vinyl-Lined Bag – High-Capacity	16.8" l x 10.5" w x 33.0" h	17.3 lb	42.6 cm x 26.6 cm x 83.8 cm	7.9 kg	4
1966882	RED	34-Gal. Janitorial Cleaning Cart Vinyl Bag – High-Capacity	16.8" l x 10.5" w x 33.0" h	9.9 lb	42.6 cm x 26.6 cm x 83.8 cm	4.5 kg	4
1966883	BLUE	34-Gal. Janitorial Cleaning Cart Vinyl Bag – High-Capacity	16.8" l x 10.5" w x 33.0" h	9.9 lb	42.6 cm x 26.6 cm x 83.8 cm	4.5 kg	4
1966885	BROWN	34-Gal. Janitorial Cleaning Cart Vinyl Bag – High-Capacity	16.8" l x 10.5" w x 33.0" h	8.4 lb	42.6 cm x 26.6 cm x 83.8 cm	3.8 kg	4
⑤ FG9T9000	BLA	Executive 9-Pocket Fabric Hanging Organizer	28.0" l x 19.8" w x 1.5" h	7.3 lb	71.1 cm x 50.2 cm x 3.8 cm	3.3 kg	6
⑤ FG9T8901	0000	Executive Triple Waste Wire Bag Divider	12.5" l x 3.0" w x 0.1" h	2.5 lb	31.8 cm x 7.6 cm x 0.3 cm	1.1 kg	1
1966719	YELLOW	24-Gal. Janitorial Cleaning Cart Vinyl Bag	9.1" l x 6.5" w x 17.3" h	6.3 lb	23.2 cm x 16.5 cm x 43.8 cm	2.9 kg	4
1966720	BLACK	24-Gal. Janitorial Cleaning Cart Vinyl Bag	9.1" l x 6.5" w x 17.3" h	6.3 lb	23.2 cm x 16.5 cm x 43.8 cm	2.9 kg	4
⑤ 1966886	BLACK	Executive 34-Gal. Janitorial Cleaning Cart Vinyl Bag – High-Capacity	16.8" l x 10.5" w x 33.0" h	17.3 lb	42.6 cm x 26.7 cm x 83.8 cm	7.9 kg	4
1966887	BROWN	30-Gal. Housekeeping Cart Canvas Vinyl-Lined Bag	16.8" l x 10.5" w x 33.0" h	17.3 lb	42.6 cm x 26.7 cm x 83.8 cm	7.9 kg	4

WASHROOM

Pails, Caddies, and Bins

NO.	COLOR	DESCRIPTION	U.S. DIMENSIONS	U.S. SHIP WT/CTN	METRIC DIMENSIONS	METRIC SHIP WT/CTN	PACK
⑤ FG9T8200	YEL, BLA	10-Quart Heavy-Duty Caddy	7.5" l x 14.0" w x 8.0" h	10.0 lb	19.1 cm x 35.6 cm x 20.3 cm	4.5 kg	6
1857376	BLUE	5-Quart Pail – Blue	7.5" l x 9.3" w x 8.5" h	6.0 lb	19.1 cm x 23.5 cm x 21.6 cm	2.7 kg	4
1857375	RED	5-Quart Pail – Red	7.5" l x 9.3" w x 8.5" h	6.0 lb	19.1 cm x 23.5 cm x 21.6 cm	2.7 kg	4
1857374	YELLOW	5-Quart Pail – Yellow	7.5" l x 9.3" w x 8.5" h	6.0 lb	19.1 cm x 23.5 cm x 21.6 cm	2.7 kg	4
1857377	GREEN	5-Quart Pail – Green	7.5" l x 9.3" w x 8.5" h	6.0 lb	19.1 cm x 23.5 cm x 21.6 cm	2.7 kg	4
⑤ 1857378	BLACK	Executive 5-Quart Heavy-Duty Pail – Black	7.5" l x 9.3" w x 8.5" h	6.0 lb	19.1 cm x 23.5 cm x 21.6 cm	2.7 kg	4
FG9T8400	YEL	30-Quart Organizing Bins – Yellow	11.0" l x 17.5" w x 14.0" h	7.0 lb	27.9 cm x 44.5 cm x 35.6 cm	3.2 kg	2
FG9T8301	MULTI	4-Pack of 5 Qt Disinfecting Pails - Blue, Red, Yellow, Green	8.3" l x 7.3" w x 9.8" h	4.5 lb	21.1 cm x 18.5 cm x 24.9 cm	1.8 kg	1

FOODSERVICE

When ordering products with **BOLD** color codes, please specify color code after the product number. Refer to the Standard Color Guide at the back of the catalog.

JANITORIAL CLEANING CART LOCKING DOOR KIT – TRADITIONAL



FG618100YEL

EXECUTIVE LOCKING SECURITY HOOD – HIGH-CAPACITY



FG9T8600BLA

EXECUTIVE WASTE COVER BAG LID WITH STORAGE – HIGH-CAPACITY



FG617900BLA

EXECUTIVE CLEANING CART LOCKING DOOR KIT - HIGH-CAPACITY



1995833

Storage and Security Kits

NO.	COLOR	DESCRIPTION	U.S. DIMENSIONS	U.S. SHIP WT/CTN	METRIC DIMENSIONS	METRIC SHIP WT/CTN	PACK
FG618100	YEL	Janitorial Cleaning Cart Locking Door Kit – Traditional	20.0" l x 16.0" w x 11.3" h	7.8 lb	50.8 cm x 40.6 cm x 28.6 cm	3.6 kg	1
1861443	BLACK	Executive Janitorial Cleaning Cart Locking Door Kit – Traditional	19.3" l x 5.5" w x 15.0" h	7.8 lb	49.1 cm x 13.8 cm x 19.3 cm	3.5 kg	1
FG9T8600	BLA	Executive Locking Security Hood - High-Capacity	9.5" l x 17.0" w x 19.0" h	8.0 lb	24.1 cm x 43.2 cm x 48.3 cm	3.6 kg	1
FG617900	BLA	Executive Cart Waste/Bag Lid with Storage – High-Capacity	17.6" l x 12.5" w x 2.4" h	3.0 lb	44.8 cm x 31.8 cm x 6.0 cm	1.4 kg	1
1995833	BLACK	Executive Janitorial Cleaning Cart Locking Door Kit – High-Capacity	16.3" l x 3.7" w x 33.8" h	11.8 lb	41.4 cm x 9.4 cm x 85.9 cm	5.4 kg	1

SLIM JIM® CONTAINER



FG354060GRAY

SLIM JIM® RECYCLING CONTAINER



FG354007BLUE

BRUTE® 44-GALLON CONTAINER



FG264360BLA



BRUTE® 32-GALLON CONTAINER



FG263200GRAY

Slim Jim® and BRUTE® Containers

NO.	COLOR	DESCRIPTION	U.S. DIMENSIONS	U.S. SHIP WT/CTN	METRIC DIMENSIONS	METRIC SHIP WT/CTN	PACK
FG354060	GRAY, BLA, BEIG	Slim Jim® with Venting Channels	22.0" l x 11.0" w x 30.0" h	30.6 lb	55.9 cm x 27.9 cm x 76.2 cm	13.9 kg	4
FG354007	GRN, BLUE	Slim Jim® with Venting Channels – Recycling	22.0" l x 11.0" w x 30.0" h	30.6 lb	55.9 cm x 27.9 cm x 76.2 cm	13.9 kg	4
FG263200	YEL, WHI, RED, GRAY, DGRN, BLUE	BRUTE® 32-Gallon Container	22.0" dia x 27.3" h	49.5 lb	55.9 cm dia x 69.2 cm	22.5 kg	6
1867531	BLACK	Executive BRUTE® 32-Gallon Container	22.0" dia x 27.3" h	49.5 lb	55.9 cm dia x 69.2 cm	22.5 kg	6
FG264360	YEL, RED, GRAY, BLUE, BLA	BRUTE® 44-Gallon Utility Container with Venting Channels	24.0" dia x 31.5" h	49.5 lb	61.0 cm dia x 80.0 cm	22.5 kg	4

For more options, see *Utility Refuse and Recycling*.



FG421288

Mechanical Sweepers

A complete line of commercial sweepers for hard floors and carpets.

MECHANICAL SWEEPER SELECTION GUIDE

MECHANICAL SWEEPER FEATURES	FG421588 EXECUTIVE DUAL-ACTION BRUSHLESS MECHANICAL SWEEPER	FG421388 EXECUTIVE DUAL-ACTION BRISTLE MECHANICAL SWEEPER	FG421288 EXECUTIVE SINGLE-ACTION BASIC MECHANICAL SWEEPER
L x W	11 1/2" x 9 1/4"	11 1/2" x 9 1/4"	9 1/2" x 9 1/4"
Sweeping Path	7 1/2"	7 1/2"	6 1/2"
Number of Brushes	Two (Bladed rotors)	Two	One
Debris Capacity	36.8 cu in	36.8 cu in	25.0 cu in
Debris Canisters	Two with viewing window	Two	One
Corner Brushes	Yes	Yes	Yes
Protective Front and Back Bumper	Yes	Yes	Yes
Soft Handle Grip	Yes	Yes	Yes
Handle Length	40.0", threaded	40.0", threaded	40.0", threaded
Handle Width	3/4"	3/4"	3/4"
Construction	Galvanized steel	Galvanized steel	Galvanized steel
Components	ABS plastic	ABS plastic	ABS plastic
Wheels	Soft rubber	Soft rubber	Soft rubber

Executive Single-Action Basic Mechanical Sweeper

Compact size to collect dust, dirt, and debris in tight spaces.

- Constructed of durable galvanized steel and tough ABS plastic
- Low-profile design provides easy access around and under furniture
- Efficient 6.5" sweep path with protective bumper
- Soft rubber wheels glide easily on any surface
- Easy-to-empty trays
- For carpet, tile, wood, vinyl, and more



BRISTLE BRUSH ROLL



NO.	COLOR	DESCRIPTION	U.S. DIMENSIONS	U.S. SHIP WT/CTN	METRIC DIMENSIONS	METRIC SHIP WT/CTN	PACK
FG421288	BLA	Executive Single-Action Basic Mechanical Sweeper	9.5" l x 8.0" w x 44.0" h	15.6 lb	24.1 cm x 20.3 cm x 111.8 cm	7.1 kg	4

Executive Dual-Action Bristle Mechanical Sweeper

Two bristle brush rolls provide effective cleaning power to collect dust, dirt, and debris.

- Constructed of durable galvanized steel and tough ABS plastic
- Low-profile design provides easy access around and under furniture
- Efficient 7.5" sweep path with protective bumper
- Soft rubber wheels glide easily on any surface
- Easy-to-empty trays
- For carpet, tile, wood, vinyl, and more



BRISTLE BRUSH ROLL



NO.	COLOR	DESCRIPTION	U.S. DIMENSIONS	U.S. SHIP WT/CTN	METRIC DIMENSIONS	METRIC SHIP WT/CTN	PACK
FG421388	BLA	Executive Dual-Action Bristle Mechanical Sweeper	10.5" l x 9.5" w x 44.0" h	19.6 lb	26.7 cm x 24.1 cm x 111.8 cm	8.9 kg	4

Executive Dual-Action Brushless Mechanical Sweeper

Two agitator rolls provide maximum cleaning power to collect dust, dirt, and debris.

- Constructed of durable galvanized steel and tough ABS plastic
- Low-profile design for easy access around and under furniture
- Wide 7.5" sweep path with protective bumper
- Tinted windows allow you to see when the sweeper needs emptying
- Easy-to-empty trays
- Soft rubber wheels glide easily on any surface
- For carpet, tile, wood, vinyl, and more



RUBBER BRUSH ROLL



NO.	COLOR	DESCRIPTION	U.S. DIMENSIONS	U.S. SHIP WT/CTN	METRIC DIMENSIONS	METRIC SHIP WT/CTN	PACK
FG421588	BLA	Executive Dual-Action Brushless Mechanical Sweeper	10.5" l x 9.5" w x 44.0" h	19.6 lb	26.7 cm x 24.1 cm x 111.8 cm	8.9 kg	4

Closet Organizer and Tool Holder

Helps increase productivity and efficiency through better tool storage and access.

- S-hooks hold 3/8" to 1 1/4" diameter handles
- Deep double hooks afford easy accessibility
- Clip holds work notes and instructions



NO.	COLOR	DESCRIPTION	U.S. DIMENSIONS	U.S. SHIP WT/CTN	METRIC DIMENSIONS	METRIC SHIP WT/CTN	PACK
FG199300	GRAY	Closet Organizer/Tool Holder Kit	34.0" l x 3.3" w x 4.3" h	10.3 lb	86.4 cm x 8.3 cm x 10.8 cm	4.7 kg	4

Ironing Organizers

Helps prevent hot iron damage.

- Installs easily virtually anywhere
- Efficiently stores iron with ironing board for guest convenience
- Durable heat-resistant thermoset plastic construction
- Aesthetic design complements guest room décor



NO.	COLOR	DESCRIPTION	U.S. DIMENSIONS	U.S. SHIP WT/CTN	METRIC DIMENSIONS	METRIC SHIP WT/CTN	PACK
FG245506	WHT	Ironing Organizer	5.3" l x 15.5" h	10.5 lb	13.3 cm x 39.4 cm	4.8 kg	6

Mobile Two-Step Stepstool

Heavy-duty stepstool glides on retractable rubber casters.

- Supports loads up to 350 lbs
- Soft, slip-resistant pads on both steps
- Wheels retract when stepped on
- Heavy-duty plastic construction minimizes damage to walls and furniture



FG252300BEIG

NO.	COLOR	DESCRIPTION	U.S. DIMENSIONS	U.S. SHIP WT/CTN	METRIC DIMENSIONS	METRIC SHIP WT/CTN	PACK
FG252300	BLA, BEIG	Mobile Two-Step Stepstool	16.0" dia x 13.5" h	5.9 lb	40.6 cm dia x 34.3 cm	2.7 kg	1

Executive Spray Bottle, 32-oz.

Makes cleaning easier and more effective.

- Adjustable nozzle, sprays up to 30"
- High-volume 3-cc spray
- Solid HDPE bottle withstands drops and bumps
- Large 3-finger trigger for easy application



EXECUTIVE SERIES™

NO.	COLOR	DESCRIPTION	U.S. DIMENSIONS	U.S. CAPACITY	U.S. SHIP WT/CTN	METRIC DIMENSIONS	METRIC CAPACITY	METRIC SHIP WT/CTN	PACK
FG9C0306	0000	Executive Spray Bottle, 32-oz.	4.8" l x 1.3" w x 13.4" h	3.3 cm ³ /32 oz	4.5 lb	12.2 cm x 3.3 cm x 34.0 cm	3.3 cm ³ /0.9 L	2.1 kg	12

Deluxe Carry Caddy

All-purpose caddy is perfect for carrying tools or cleaning supplies.

- Heavy-duty caddy conveniently fits on cleaning and housekeeping carts
- Securely holds up to eight 32-oz spray bottles and other common cleaning tools
- Ergonomic handle design provides comfortable fit



EXECUTIVE SERIES™
1880994

FG315488

NO.	COLOR	DESCRIPTION	U.S. DIMENSIONS	U.S. SHIP WT/CTN	METRIC DIMENSIONS	METRIC SHIP WT/CTN	PACK
FG315488	BLA	Deluxe Carry Caddy	15.0" l x 10.9" w x 7.4" h	7.5 lb	38.1 cm x 27.7 cm x 18.8 cm	3.4 kg	6
1880994	BLACK	Executive Divided Carry Caddy	15.2" l x 10.8" w x 6.5" h	1.3 lb	38.7 cm x 27.3 cm x 16.5 cm	0.6 kg	6

COMPLETE CLEANING SYSTEMS

Rubbermaid Commercial Products' cleaning products are designed to work together to form complete cleaning systems. The FG9C0306 Spray Bottle and Trigger fits smartly in BRUTE® Caddies, and Cleaning Carts.



UTILITY REFUSE AND RECYCLING

DECORATIVE REFUSE

CLEANING

MATERIAL HANDLING

WASHROOM

FOODSERVICE

ACCESSORIES & INDEX



SAFETY



FG611277YEL



FG611200YEL

SAFETY SIGNS

- Floor Safety Signs 144
- Executive Wooden Multilingual
- Caution Signs 145
- Site Safety Hanging Signs 145

SAFETY CONES

- Pop-Up Safety Cones 146
- Safety Cones and Accessories 146

BARRIERS & ABSORBENTS

- Mobile Barrier 147
- Over-the-Spill® System 147

LOOK FOR THE SPECIALLY MARKED **EXECUTIVE SERIES™** PRODUCTS.

SAFETY

UTILITY REFUSE
AND RECYCLING

DECORATIVE REFUSE

SAFETY

MATERIAL HANDLING

WASHROOM

FOODSERVICE

ACCESSORIES
& INDEX

Floor Safety Signs

Lightweight, versatile signs for effective safety communication.

- “Closed” and “Caution” warning messages imprinted in English, French, and Spanish
- Folds for convenient storage and transport on janitorial carts or Rim Caddy (FG9W8700)
- Two- and four-sided models available
- ANSI- and OSHA-compliant color* and graphics**



EXECUTIVE SERIES™

1867505*



FG611477

FG611277

FG611278

FG611200

FG9S0900

NO.	COLOR	DESCRIPTION	U.S. DIMENSIONS	U.S. SHIP WT/CTN	METRIC DIMENSIONS	METRIC SHIP WT/CTN	PACK
FG611200	YEL	Floor Sign with Multilingual “Caution” Imprint, 2-Sided	Open: 26.0" l x 11.0" w x 25.0" h Closed: 26.0" l x 11.0" w	15.0 lb	Open: 66.0 cm x 27.9 cm x 63.5 cm Closed: 66.0 cm x 27.9 cm	6.8 kg	6
① 1867505*	BLACK	Executive Multilingual Caution Sign, 2-Sided, Black	Open: 26.0" l x 11.0" w x 25.0" h Closed: 26.0" l x 11.0" w	15.0 lb	Open: 66.0 cm x 27.9 cm x 63.5 cm Closed: 66.0 cm x 27.9 cm	6.8 kg	6
FG611277	YEL	Floor Sign with “Caution Wet Floor” Imprint, 2-Sided	Open: 26.0" l x 11.0" w x 25.0" h Closed: 26.0" l x 11.0" w	15.0 lb	Open: 66.0 cm x 27.9 cm x 63.5 cm Closed: 66.0 cm x 27.9 cm	6.8 kg	6
FG611278	YEL	Floor Sign with Multilingual “Closed” Imprint, 2-sided	Open: 26.0" l x 11.0" w x 25.0" h Closed: 26.0" l x 11.0" w	15.0 lb	Open: 66.0 cm x 27.9 cm x 63.5 cm Closed: 66.0 cm x 27.9 cm	6.8 kg	6
FG611477	YEL	Floor Sign with “Caution Wet Floor” Imprint, 4-Sided	Open: 38.0" l x 12.0" w x 37.0" h Closed: 38.0" l x 12.0" w	26.9 lb	Open: 96.5 cm x 30.5 cm x 94.0 cm Closed: 96.5 cm x 30.5 cm	12.2 kg	6
FG9S0900	YEL	Stable Floor Sign with Multilingual “Caution” Imprint, 2-Sided	Open: 13.0" l x 32.5" w Closed: 13.0" l x 32.5" w	11.5 lb	Open: 33.0 cm x 82.0 cm Closed: 33.0 cm x 82.0 cm	5.2 kg	6

*Applies to yellow signs only. Executive Series™ gray and black Caution Signs are NOT compliant with OSHA nor ANSI color or graphics. FG611278 is NOT compliant with OSHA nor ANSI graphics.

**ANSI Z535.3–2002 Criteria for Safety Symbols; ANSI Z535–Safety Color; OSHA 1910.144–Safety Color; OSHA 1910.145–Specification for Accident Prevention Signage.

When ordering products with **BOLD** color codes, please specify color code after the product number. Refer to the Standard Color Guide at the back of the catalog.

Executive Wooden Multilingual Caution Signs

2-sided hinged Caution signs.

- Elegant dark hardwood frame
- Durable plastic feet help protect wood finish from spills
- Hinged top with integrated carry handle for easy transport and storage
- Available in gold
- Trilingual Caution plate



1867507

NO.	COLOR	DESCRIPTION	U.S. DIMENSIONS	U.S. SHIP WT/CTN	METRIC DIMENSIONS	METRIC SHIP WT/CTN	PACK
1867507	GOLD	Executive Wooden Multilingual Caution Sign, 2-Sided, Gold	Open: 22.0" l x 15.1" w x 20.0" d Closed: 23.8" l x 15.1" w x 2.3" d	13.5 lb	Open: 55.9 cm x 38.4 cm x 50.8 cm Closed: 60.3 cm x 38.4 cm x 5.7 cm	6.2 kg	1

Site Safety Hanging Signs

Sign and pole combination for blocking doorways and entrances.

- Twisting action secures pole in doorways up to 50" wide to prohibit entry
- Soft, pliable sign rolls around pole for easy storage
- ANSI- and OSHA-compliant color



FG9S1600



NO.	COLOR	DESCRIPTION	U.S. DIMENSIONS	U.S. SHIP WT/CTN	METRIC DIMENSIONS	METRIC SHIP WT/CTN	PACK
FG9S1500	YEL	Site Safety Hanging Sign with "Closed for Cleaning" Imprint – English Only	Closed: 13.0" h x 28.0" w x 1.0" d Open: 13.0" h x 50.3" w x 1.0" d	5.5 lb	33.0 cm x 71.12 cm x 2.5 cm 33.0 cm x 127.6 cm x 2.5 cm	2.5 kg	6
FG9S1600	YEL	Site Safety Hanging Sign with Multilingual "Closed for Cleaning" Imprint	Closed: 13.0" h x 27.8" w x 1.0" d Open: 13.0" h x 50.0" w x 1.0" d	5.5 lb	33.0 cm x 70.5 cm x 2.5 cm 33.0 cm x 127.0 cm x 2.5 cm	2.5 kg	6

Pop-Up Safety Cones

Collapsible, automatically deployable cone.

- Durable cone material withstands rough handling
- Wall-mounted, shatterproof storage tube provides easy and compact storage
- Storage tube mounting hardware includes tape and screws
- ANSI- and OSHA-compliant color* and graphics**



NO.	COLOR	DESCRIPTION	U.S. DIMENSIONS	U.S. SHIP WT/CTN	METRIC DIMENSIONS	METRIC SHIP WT/CTN	PACK
FG9S0000	YEL	Pop-Up Safety Cone, 20" (50.8 cm) with Multilingual "Caution" Imprint and Wet Floor Symbol	21.0" dia x 21.0" w x 20.0" h	12.7 lb	53.3 cm dia x 53.3 cm x 50.8 cm	5.8 kg	12
FG9S0100	YEL	Pop-Up Safety Cone, 30" (76.2 cm) with Multilingual "Caution" Imprint and Wet Floor Symbol	21.0" dia x 21.0" w x 30.0" h	23.5 lb	53.3 cm dia x 53.3 cm x 76.2 cm	10.7 kg	12

Safety Cones and Accessories

Highly visible, bright yellow hazard protection system.

- Versatile top design accommodates barricade belt, flashing light, lock-in sign holder, and accessories
- Four-sided shape for efficient stacking
- Multilingual imprinted warning messages provide effective communication with broad audiences
- Molded-in slots for easy handling
- Can be used with BRUTE® Square Dolly (FG353000) for easy transport
- ANSI- and OSHA-compliant color*



FG627600

FG627677

FG627777

NO.	COLOR	DESCRIPTION	U.S. DIMENSIONS	U.S. SHIP WT/CTN	METRIC DIMENSIONS	METRIC SHIP WT/CTN	PACK
FG353000	BLA	BRUTE® Square Dolly	17.3" sq x 6.3" h	18.5 lb	43.8 cm sq x 15.9 cm	8.4 kg	2
FG627600	YEL	Safety Cone 36" (91.4 cm) with Multilingual "Caution" Imprint	12.2" l x 12.3" w x 36.0" h	17.6 lb	31.1 cm x 31.1 cm x 91.4 cm	8.0 kg	5
FG627677	YEL	Safety Cone 36" (91.4 cm) with Multilingual "Caution Wet Floor" Imprint	12.3" l x 12.3" w x 36.0" h	17.6 lb	31.1 cm x 31.1 cm x 91.4 cm	8.0 kg	5
FG627777	YEL	Safety Cone 25.8" (65.4 cm) with Multilingual "Caution Wet Floor" Imprint	10.5" l x 10.5" w x 25.8" h	14.0 lb	26.7 cm x 26.7 cm x 65.4 cm	6.4 kg	6

*Applies to yellow signs only.

**ANSI Z535.3–2002 Criteria for Safety Symbols; ANSI Z535–Safety Color; OSHA 1910.144–Safety Color; OSHA 1910.145–Specification for Accident Prevention Signage.

Mobile Barrier

Easy to use, highly visible mobile barrier for use in many situations.

- Flexible panels allow straight, curved, and circular configurations
- Extends to 13' when fully opened; locking straps keep barrier closed when not in use
- Lightweight and compact (2' x 13" footprint when closed)
- Two 5" non-marking wheels and 4 locking straps provide mobility and stability
- ANSI- and OSHA-compliant color*
- For indoor use; shipped assembled

Work around electrical equipment?

Excerpt from OSHA reg. 29 CFR 1910.335 (b)(2): "Barricades shall be used...to prevent or limit employee access to work areas...Conductive [metal] barricades may not be used where they might cause an electrical contact hazard."



NO.	COLOR	DESCRIPTION	U.S. DIMENSIONS	U.S. SHIP WT/CTN	METRIC DIMENSIONS	METRIC SHIP WT/CTN	PACK
FG9S1100	YEL	Mobile Barrier	Open: 40.0" h x 13.0' l x 1.0" w Closed: 40.0" h x 2.0' l x 13.0" w	37.0 lb	Open: 101.6 cm x 396.0 cm x 2.5 cm Closed: 101.6 cm x 61.0 cm x 33.0 cm	16.8 kg	1

Spills happen unexpectedly, creating hazards for patrons and staff which need to be cleaned up as quickly as possible to avoid injuries. Using a string mop and bucket can be time-consuming and leaves the floor wet. Over-the-Spill Pads make it easier to cover and absorb spills while simultaneously alerting pedestrians to potential slip-and-fall hazards.

20%
OF ALL WORKPLACE
INJURIES INVOLVING DAYS
AWAY FROM WORK ARE DUE
TO **SLIPS, TRIPS AND FALLS.**¹



\$48,575
IS THE AVERAGE
SLIP/FALL INJURY
COST IN WORKERS'
COMPENSATION EXPENSES.²



¹ Retrieved from: <https://injuryfacts.nsc.org/work/work-overview/top-work-related-injury-causes/data-details/>

² Retrieved from: <https://injuryfacts.nsc.org/work/costs/workers-compensation-costs/>

Over-the-Spill® System

Slip-resistant pads quickly cover spills and alert pedestrians.

- Each yellow pad is coded with universal caution symbol and "Caution Wet Floor" message in English and Spanish
- Dispensing station mounts on flat surfaces
- Pads absorb up to 14oz of liquid for faster cleanup

FG425100



FG425400



FG425400 on FG611200

NO.	COLOR	DESCRIPTION	U.S. DIMENSIONS	U.S. SHIP WT/CTN	METRIC DIMENSIONS	METRIC SHIP WT/CTN	PACK
FG425100	YEL	Over-the-Spill® Station Kit includes Pad Dispenser, 22 Large Pads, and Fasteners	21.0" l x 17.8" w	14.0 lb	53.3 cm x 45.1 cm	6.4 kg	6
FG425200	YEL	Over-the-Spill® Station Pads, Large; Refill Pads for FG425100, Contains 22 Pads	20.0" l x 16.5" w	25.0 lb	50.8 cm x 41.9 cm	11.3 kg	12
FG425300	YEL	Over-the-Spill® Station Pads, Medium; Refill Pads for FG425100, Contains 22 Pads	16.5" l x 14.0" w	17.0 lb	41.9 cm x 35.6 cm	7.7 kg	12
FG425400	YEL	Over-the-Spill® Pad Tablet, Contains 22 Pads	16.5" l x 14.0" w	20.0 lb	41.9 cm x 35.6 cm	9.1 kg	12

*Applies to yellow signs only.

**ANSI Z535.3-2002 Criteria for Safety Symbols; ANSI Z535-Safety Color; OSHA 1910.144-Safety Color; OSHA 1910.145-Specification for Accident Prevention Signage.



MATERIAL HANDLING



2192462



FG452088

MATERIAL HANDLING

UTILITY REFUSE
AND RECYCLING

DECORATIVE REFUSE

CLEANING

MATERIAL HANDLING

WASHROOM

FOODSERVICE

ACCESSORIES
& INDEX

BULK COLLECTION

Motorized Tilt Trucks.....	154
Structural Foam Tilt Trucks.....	156
Rotomolded Tilt Trucks.....	157
Specialty Rotomolded Tilt Trucks.....	158
Rotomolded Tilt Truck Lids.....	158
Self-Dumping Hoppers.....	159
Mega BRUTE® Mobile Collectors.....	159
Cube Trucks.....	160
Collapsible X-Carts.....	161
Premium Linen Hamper.....	161

UTILITY CARTS

Heavy-Duty Adaptable Carts.....	163
Heavy-Duty Utility Carts.....	164
Trades Carts.....	166
5-Drawer Mobile Work Center.....	166
TradeMaster® Mobile Cabinets and Work Centers.....	167
Convertible Utility Cart.....	167
Executive Series™ Service Cart.....	168
Service Carts.....	169
Xtra™ Carts.....	169

PLATFORM TRUCKS

Heavy-Duty Platform Trucks.....	171
Motorized Kits and Accessories.....	172
Towable Pallet Cart & Platform Truck.....	173
Sheet and Panel Truck.....	174
Side-Panel Platform Truck.....	175

ORDER PICKING SOLUTIONS

Tote Picking Cart and Accessories.....	177
Digital Receiving Utility Scales.....	177

CASTERS TO MEET YOUR NEEDS

Caster Performance Guide.....	178
-------------------------------	-----

CART ACCESSORIES

Cart Accessories.....	179
-----------------------	-----

OUTDOOR HANDLING AND STORAGE

Stock Tanks.....	181
Big Wheel Carts.....	182
BRUTE® Totes.....	183
Stack and Nest Palletote® Boxes.....	183



Made using
Recycled Material.*

* Made using resin blend of 50% or more recycled material.

UTILITY REFUSE
AND RECYCLING

DECORATIVE REFUSE

CLEANING

MATERIAL HANDLING

WASHROOM

FOODSERVICE

ACCESSORIES
& INDEX

BRUTE MATERIAL

HANDLING SOLUTIONS

MADE TO MOVE. BUILT TO LAST.

Backed by a 10-year limited warranty, our BRUTE material handling solutions are crafted with durable, commercial-grade resin.





EXCEPTIONAL DURABILITY

BRUTE Tilt Trucks and Utility Carts won't warp, dent, or rot for exceptional durability.



IMPROVED STABILITY

BRUTE Utility Carts feature locking casters that keep the cart in place when loading and unloading.

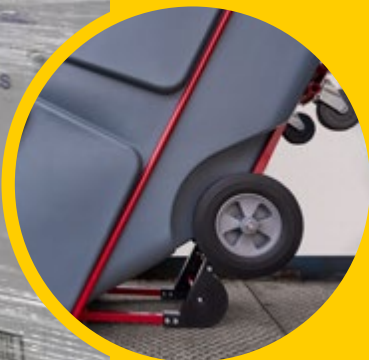

ENHANCED CONTROL

BRUTE Tilt Trucks are designed with DuraTilt™ frame, which enable them to stay stable while in the tilted position, making the dumping and cleaning process easier than traditional metal frames.

UTILITY REFUSE
AND RECYCLING

DECORATIVE REFUSE

CLEANING

MATERIAL HANDLING

WASHROOM

FOODSERVICE

ACCESSORIES
& INDEX



MOTORIZED TILT

TRUCK SOLUTIONS

MOVE HEAVY LOADS WITH LESS EFFORT

Spending >50% of the day on pushing & pulling tasks increases injury risk by ~5x.¹ The Motorized Rotomolded Tilt Truck is ideal for users who want the benefits of using cordless motorized power for moving heavy loads and reducing user strain.



1. MiekeKoeHoorn , Aleck Ostry , Shahadut Hossain & Judy Village (2011) Injury risk associated with physical demands and school environment characteristics among a cohort of custodial workers, Ergonomics, 54:8, 767-775, DOI: 10.1080/00140139.2011.592603 Industrial Safety & Occupational Health Markets 5th Edition.



REDUCE STRAIN

The battery-powered kit virtually eliminates the need for manual force, reducing strain experienced by users when pushing heavy loads up to 1,000 lbs.



SAVE TIME

Substituting manual power for battery power helps regain time lost over the course of a shift due to cumulative fatigue.



DECREASE DOWNTIME

Dual onboard battery compartments provide back-up power without having to plug in the entire truck, minimizing costly workflow disruptions due to battery switch outs.

UTILITY REFUSE
AND RECYCLING

DECORATIVE REFUSE

CLEANING

MATERIAL HANDLING

WASHROOM

FOODSERVICE

ACCESSORIES
& INDEX



Motorized Tilt Trucks**Move heavy loads with less effort.**

- Battery powered kit virtually eliminates the need for manual force, reducing strain experienced by users when pushing heavy loads up to 1,000 lbs
- Substituting manual power for battery power helps regain time lost over the course of a shift due to cumulative fatigue
- Dual onboard battery compartments provide back-up power without having to plug in the entire truck, minimizing costly workflow disruptions due to battery switch outs

DECORATIVE REFUSE

CLEANING

MATERIAL HANDLING

WASHROOM

FOODSERVICE

ACCESSORIES
& INDEX

2173519



2173662

1
The risk of low back pain is more likely during initial push force when moving heavy loads manually.



2
Use of motorization with the tilt truck helps reduce strain on the lower back.

NO.	COLOR	DESCRIPTION	U.S. DIMENSIONS	U.S. SIZE	U.S. CAPACITY	U.S. SHIP WT/CTN	METRIC DIMENSIONS	METRIC SIZE	METRIC CAPACITY	METRIC SHIP WT/CTN	PACK
2173519	BLACK	Motorized Roto Tilt Truck 0.5 CU YD	62.8" l x 28.0" w x 38.6" h	0.5 cu yd	850.0 lb	93.0 lb	159.4 cm x 711.2 cm x 98.1 cm	1.11 m ³	385.5 kg	42.2 kg	1
2173662	BLACK	Motorized Roto Tilt Truck 1.0 CU YD	78.3" l x 33.5" w x 43.8" h	1.0 cu yd	1,000.0 lb	132.0 lb	198.8 cm x 85.1 cm x 111.1 cm	1.88 m ³	453.6 kg	59.9 kg	1
2173664	BLACK	Motorized Kit Universal Battery	6.8" l x 4.8" w x 3.5" h	N/A	N/A	4.3 lb	17.1 cm x 12.1 cm x 8.3 cm	N/A	N/A	1.9 kg	1
2173520	BLACK	Motorized Kit Charger	6.3" l x 7.3" w x 2.3" h	N/A	N/A	1.5 lb	15.9 cm x 18.4 cm x 5.7 cm	N/A	N/A	0.8 kg	1

See page 157 for compatible lids

When ordering products with **BOLD** color codes, please specify color code after the product number. Refer to the Standard Color Guide at the back of the catalog.



UTILITY REFUSE
AND RECYCLING

DECORATIVE REFUSE

CLEANING

MATERIAL HANDLING

WASHROOM

FOODSERVICE

ACCESSORIES
& INDEX

2173519

Structural Foam Tilt Trucks

Durable one-piece body for decreased maintenance.

- Ergonomic handles for better handling and steering
- Easy to clean inside and out
- Unibody design promotes a more discreet appearance in public areas
- Fits through standard commercial doorways and onto elevators
- Optional domed lid available



The ergonomically designed "steering wheel" handle provides excellent handling and maneuvering.



Inset wheel position prevents damage to surroundings.



FG101100BLA



FG102800BLA

1/2-Cubic-Yard Tilt Trucks

NO.	COLOR	DESCRIPTION	U.S. DIMENSIONS	U.S. SIZE	U.S. CAPACITY	U.S. SHIP WT/CTN	METRIC DIMENSIONS	METRIC SIZE	METRIC CAPACITY	METRIC SHIP WT/CTN	PACK
FG9T1300	BLA	Structural Foam Tilt Truck, Utility-Duty	57.4" l x 26.9" w x 33.9" h	½ cu yd	450.0 lb	86.9 lb	145.7 cm x 68.3 cm x 86.1 cm	0.4 m³	204.1 kg	39.4 kg	1
FG9T1400	BLA	Structural Foam Tilt Truck, Standard-Duty	57.4" l x 26.9" w x 33.9" h	½ cu yd	850.0 lb	95.9 lb	145.7 cm x 68.3 cm x 86.1 cm	0.4 m³	385.6 kg	43.5 kg	1
FG9T2200	BLA	Lid for 1/2-Cubic-Yard Tilt Trucks	52.0" l x 27.9" w x 9.0" h	N/A	N/A	25.3 lb	132.1 cm x 70.8 cm x 22.9 cm	N/A	N/A	11.5 kg	1

3/4-Cubic-Yard Tilt Trucks

NO.	COLOR	DESCRIPTION	U.S. DIMENSIONS	U.S. SIZE	U.S. CAPACITY	U.S. SHIP WT/CTN	METRIC DIMENSIONS	METRIC SIZE	METRIC CAPACITY	METRIC SHIP WT/CTN	PACK
FG101100	BLA	Structural Foam Tilt Truck, Utility-Duty	64.5" l x 30.3" w x 38.0" h	¾ cu yd	600.0 lb	92.0 lb	163.8 cm x 76.8 cm x 96.5 cm	0.6 m³	272.1 kg	41.7 kg	1
FG101300	BLA	Structural Foam Tilt Truck, Standard-Duty	64.5" l x 30.3" w x 38.0" h	¾ cu yd	1,000.0 lb	101.0 lb	163.8 cm x 76.8 cm x 96.5 cm	0.6 m³	453.6 kg	45.8 kg	1
FG102800	BLA	Lid for 3/4-Cubic-Yard Tilt Trucks	61.0" l x 31.8" w x 8.8" h	N/A	N/A	24.8 lb	154.9 cm x 80.6 cm x 22.2 cm	N/A	N/A	11.2 kg	1

1-Cubic-Yard Tilt Trucks

NO.	COLOR	DESCRIPTION	U.S. DIMENSIONS	U.S. SIZE	U.S. CAPACITY	U.S. SHIP WT/CTN	METRIC DIMENSIONS	METRIC SIZE	METRIC CAPACITY	METRIC SHIP WT/CTN	PACK
FG9T1500	BLA	Structural Foam Tilt Truck, Standard-Duty	70.8" l x 33.5" w x 42.3" h	1.0 cu yd	1,250.0 lb	139.1 lb	179.7 cm x 85.1 cm x 107.3 cm	0.8 m³	566.9 kg	63.1 kg	1
FG9T1600	BLA	Structural Foam Tilt Truck, Heavy-Duty	70.8" l x 33.5" w x 42.3" h	1.0 cu yd	2,100.0 lb	141.1 lb	179.7 cm x 85.1 cm x 107.3 cm	0.8 m³	952.5 kg	64.0 kg	1
FG9T2300	BLA	Lid for 1-Cubic-Yard Tilt Trucks	66.9" l x 34.5" w x 9.0" h	N/A	N/A	36.6 lb	169.9 cm x 87.6 cm x 22.9 cm	N/A	N/A	16.6 kg	1



Made using Recycled Material*

When ordering products with **BOLD** color codes, please specify color code after the product number. Refer to the Standard Color Guide at the back of the catalog.

Rotomolded Tilt Trucks

Durable rotational molded trucks handle heavy loads with ease.

- Leakproof polyethylene body won't dent, chip or peel**
- Seamless one-piece body is easy to clean inside and out
- Flexible body does not break when heavy materials are dropped into truck
- Balanced design allows for easy dumping by one person
- Optional hinged lid available
- DuraTilt™ Frame allows the Tilt Truck to stay stable while in the tilted position making the dumping and cleaning process easier than traditional metal frames



FG130573BLUE



FG131400BLA



FG131700BLA

1/2-Cubic-Yard Tilt Trucks

NO.	COLOR	DESCRIPTION	U.S. DIMENSIONS	U.S. SIZE	U.S. CAPACITY	U.S. SHIP WT/CTN	METRIC DIMENSIONS	METRIC SIZE	METRIC CAPACITY	METRIC SHIP WT/CTN	PACK
FG130400*	BLA	Tilt Truck, Utility-Duty (RM)	56.8" l x 28.0" w x 38.6" h	½ cu yd	450.0 lb	62.5 lb	144.1 cm x 71.1 cm x 98.1 cm	0.4 m³	204.1 kg	28.3 kg	1
FG130500*	BLA***	BRUTE Tilt Truck, Standard-Duty (RM)	60.5" l x 28.0" w x 38.6" h	½ cu yd	850.0 lb	77.0 lb	153.7 cm x 71.1 cm x 98.1 cm	0.4 m³	385.6 kg	34.9 kg	1
2192466	GRAY***	BRUTE Tilt Truck, Standard-Duty (RM)	60.5" l x 28.0" w x 38.6" h	½ cu yd	850.0 lb	77.0 lb	153.7 cm x 71.1 cm x 98.1 cm	0.4 m³	385.6 kg	34.9 kg	1
FG130573	BLUE***	BRUTE Recycling Tilt Truck, Standard-Duty (RM)	60.5" l x 28.0" w x 38.6" h	½ cu yd	850.0 lb	77.0 lb	153.7 cm x 71.1 cm x 98.1 cm	0.4 m³	385.6 kg	34.9 kg	1
FG130600*	BLA***	BRUTE Tilt Truck, Heavy-Duty (RM)	60.5" l x 28.0" w x 38.6" h	½ cu yd	1,400.0 lb	88.0 lb	153.7 cm x 71.1 cm x 98.1 cm	0.4 m³	635.0 kg	39.9 kg	1
2192465	GRAY***	BRUTE Tilt Truck, Heavy-Duty (RM)	60.5" l x 28.0" w x 38.6" h	½ cu yd	1,400.0 lb	88.0 lb	153.7 cm x 71.1 cm x 98.1 cm	0.4 m³	635.0 kg	39.9 kg	1
FG130700	BLA	Lid for ½ Cubic Yard Tilt Trucks	56.5" l x 28.5" w x 9.0" h	N/A	N/A	22.3 lb	143.5 cm x 72.4 cm x 22.9 cm	N/A	N/A	10.1 kg	1

1-Cubic-Yard Tilt Trucks

NO.	COLOR	DESCRIPTION	U.S. DIMENSIONS	U.S. SIZE	U.S. CAPACITY	U.S. SHIP WT/CTN	METRIC DIMENSIONS	METRIC SIZE	METRIC CAPACITY	METRIC SHIP WT/CTN	PACK
FG131400*	BLA	Tilt Truck, Utility-Duty (RM)	72.3" l x 33.5" w x 43.8" h	1.0 cu yd	850.0 lb	111.0 lb	183.5 cm x 85.1 cm x 111.1 cm	0.8 m³	385.6 kg	50.3 kg	1
FG131500*	RED***, BLA***	BRUTE Tilt Truck, Standard-Duty (RM)	72.3" l x 33.5" w x 43.8" h	1.0 cu yd	1,250.0 lb	111.0 lb	183.5 cm x 85.1 cm x 111.1 cm	0.8 m³	567.0 kg	50.3 kg	1
2192462*	GRAY***	BRUTE Tilt Truck, Standard-Duty (RM)	72.3" l x 33.5" w x 43.8" h	1.0 cu yd	1,250.0 lb	111.0 lb	183.5 cm x 85.1 cm x 111.1 cm	0.8 m³	567.0 kg	50.3 kg	1
2089826	BLUE***	BRUTE Recycling Tilt Truck, Standard-Duty (RM)	72.3" l x 33.5" w x 43.8" h	1.0 cu yd	1,250.0 lb	111.0 lb	183.5 cm x 85.1 cm x 111.1 cm	0.8 m³	567.0 kg	50.3 kg	1
FG131600*	BLA***	BRUTE Tilt Truck, Heavy-Duty (RM)	72.3" l x 33.5" w x 43.8" h	1.0 cu yd	2,100.0 lb	120.0 lb	183.5 cm x 85.1 cm x 111.1 cm	0.8 m³	952.5 kg	54.4 kg	1
2192467*	GRAY***	BRUTE Tilt Truck, Heavy-Duty (RM)	72.3" l x 33.5" w x 43.8" h	1.0 cu yd	2,100.0 lb	120.0 lb	183.5 cm x 85.1 cm x 111.1 cm	0.8 m³	952.5 kg	54.4 kg	1
FG131700	BLA	Lid for 1 Cubic Yard Tilt Trucks	69.5" l x 34.0" w x 8.5" h	N/A	N/A	24.0 lb	176.5 cm x 86.4 cm x 21.6 cm	N/A	N/A	10.9 kg	1

1 1/2-Cubic-Yard Tilt Trucks

NO.	COLOR	DESCRIPTION	U.S. DIMENSIONS	U.S. SIZE	U.S. CAPACITY	U.S. SHIP WT/CTN	METRIC DIMENSIONS	METRIC SIZE	METRIC CAPACITY	METRIC SHIP WT/CTN	PACK
FG102500*	BLA	BRUTE Tilt Truck, Standard-Duty (RM)	80.5" l x 43.0" w x 49.5" h	1½ cu yd	1,200.0 lb	212.0 lb	204.5 cm x 109.2 cm x 125.7 cm	1.1 m³	544.3 kg	96.2 kg	1
FG102700*	BLA	Lid for 1½ Cubic Yard Tilt Trucks	82.9" l x 44.5" w x 3.0" h	N/A	N/A	32.8 lb	210.5 cm x 113.0 cm x 7.6 cm	N/A	N/A	11.5 kg	1

2-Cubic-Yard Tilt Trucks

NO.	COLOR	DESCRIPTION	U.S. DIMENSIONS	U.S. SIZE	U.S. CAPACITY	U.S. SHIP WT/CTN	METRIC DIMENSIONS	METRIC SIZE	METRIC CAPACITY	METRIC SHIP WT/CTN	PACK
FG103600*	BLA	BRUTE Tilt Truck, Heavy-Duty (RM)	81.3" l x 46.8" w x 50.0" h	2.0 cu yd	2,300.0 lb	238.5 lb	206.4 cm x 118.7 cm x 127.0 cm	1.5 m³	1043.3 kg	108.2 kg	1

2 1/2-Cubic-Yard Tilt Trucks

NO.	COLOR	DESCRIPTION	U.S. DIMENSIONS	U.S. SIZE	U.S. CAPACITY	U.S. SHIP WT/CTN	METRIC DIMENSIONS	METRIC SIZE	METRIC CAPACITY	METRIC SHIP WT/CTN	PACK
FG104600*	BLA	BRUTE Tilt Truck, Heavy-Duty (RM)	81.5" l x 55.5" w x 50.0" h	2½ cu yd	2,300.0 lb	231.4 lb	207.0 cm x 141.0 cm x 127.0 cm	1.9 m³	1043.3 kg	105.0 kg	1

RM = Rotational Molded

* FDA Compliant

** Leakproof up to the handle level of the truck

*** Features DuraTilt™ Frame



Specialty Rotomolded Tilt Trucks

Towable and forkliftable tilt trucks increase efficiency when moving heavy loads.

- Easily tow up to 3 trucks at once with a towing vehicle, using the heavy-duty tow bar and hitch
- Forkliftable models are compatible with forklifts and automated lifters
- Pneumatic wheels provide smooth movement over rough terrain
- Available in ½, 1, and 1½ cu yd sizes



FG131641BLA



FG131542BLA

1-Cubic-Yard Tilt Trucks

NO.	COLOR	DESCRIPTION	U.S. DIMENSIONS	U.S. SIZE	U.S. CAPACITY	U.S. SHIP WT/CTN	METRIC DIMENSIONS	METRIC SIZE	METRIC CAPACITY	METRIC SHIP WT/CTN	PACK
FG131641*	BLA	BRUTE Towable Trainable Tilt Truck, Heavy-Duty (RM)	72.5" l x 33.5" w x 42.3" h	1.0 cu yd	2,100.0 lb	178.0 lb	184.2 cm x 85.1 cm x 107.3 cm	0.8 m ³	952.6 kg	80.7 kg	1
FG131542	BLA**	BRUTE Forkliftable Tilt Truck, Standard Duty (RM)	72.3" l x 33.5" w x 43.8" h	1.0 cu yd	1,250.0 lb	124.0 lb	183.5 cm x 85.1 cm x 111.1 cm	0.8 m ³	567.0 kg	56.2 kg	1

1½-Cubic-Yard Tilt Trucks

NO.	COLOR	DESCRIPTION	U.S. DIMENSIONS	U.S. SIZE	U.S. CAPACITY	U.S. SHIP WT/CTN	METRIC DIMENSIONS	METRIC SIZE	METRIC CAPACITY	METRIC SHIP WT/CTN	PACK
FG102641*	BLA	BRUTE Towable Trainable Tilt Truck, Heavy-Duty (RM)	92.0" l x 44.0" w x 51.0" h	1½ cu yd	2,100.0 lb	232.0 lb	233.7 cm x 111.8 cm x 129.5 cm	1.14 m ³	952.6 kg	105.3 kg	1
FG102542	BLA**	BRUTE Forkliftable Tilt Truck, Standard-Duty (RM)	80.5" l x 43.0" w x 49.5" h	1½ cu yd	1,500.0 lb	211.9 lb	204.5 cm x 109.2 cm x 125.7	1.14 m ³	680.3 kg	96.1 kg	1

Rotomolded Tilt Truck Lids

Domed, hinged lids provide convenient access to contents without reducing overall capacity.



FG131700BLA

NO.	COLOR	DESCRIPTION	U.S. DIMENSIONS	U.S. SIZE	U.S. CAPACITY	U.S. SHIP WT/CTN	METRIC DIMENSIONS	METRIC SIZE	METRIC CAPACITY	METRIC SHIP WT/CTN	PACK
FG130700	BLA	Lid for ½-Cubic-Yard Tilt Trucks	56.5" l x 28.5" w x 9.0" h	N/A	N/A	22.3 lb	143.5 cm x 72.4 cm x 22.9 cm	N/A	N/A	10.1 kg	1
FG131700	BLA	Lid for 1-Cubic-Yard Tilt Trucks	69.5" l x 34.0" w x 8.5" h	N/A	N/A	24.0 lb	176.5 cm x 86.4 cm x 21.6 cm	N/A	N/A	10.9 kg	1
FG102700	BLA	Lid for 1½-Cubic-Yard Tilt Trucks	82.9" l x 44.5" w x 3.0" h	N/A	N/A	32.8 lb	210.5 cm x 113.0 cm x 7.6 cm	N/A	N/A	14.9 kg	1

*Pneumatic Wheels RM = Rotational Molded

** Features DuraTilt(tm) Frame

When ordering products with **BOLD** color codes, please specify color code after the product number. Refer to the Standard Color Guide at the back of the catalog.

Self-Dumping Hoppers

Large-capacity hoppers store and dump heavy loads with ease.

- Tilts a full 30° below horizontal to ensure complete dumping
- Pull-release safety latch prohibits premature dumping
- Resists rusting, denting, and pitting that can affect metal hoppers



FG105443BLA

1/2-Cubic-Yard Hoppers

NO.	COLOR	DESCRIPTION	U.S. DIMENSIONS	U.S. SIZE	U.S. CAPACITY	U.S. SHIP WT/CTN	METRIC DIMENSIONS	METRIC SIZE	METRIC CAPACITY	METRIC SHIP WT/CTN	PACK
FG105443	BLA	Self-Dumping Hopper with four 6" dia (15.2 cm) Polyolefin Casters	55.0" l x 26.3" w x 47.6" h	1/2 cu yd	750.0 lb	212.0 lb	139.7 cm x 66.7 cm x 121.0 cm	0.4 m ³	340.2 kg	96.2 kg	1

1-Cubic-Yard Hoppers

NO.	COLOR	DESCRIPTION	U.S. DIMENSIONS	U.S. SIZE	U.S. CAPACITY	U.S. SHIP WT/CTN	METRIC DIMENSIONS	METRIC SIZE	METRIC CAPACITY	METRIC SHIP WT/CTN	PACK
FG105943	BLA	Self-Dumping Hopper with four 6" dia (15.2 cm) Polyolefin Casters	71.5" l x 31.3" w x 52.5" h	1.0 cu yd	1,000.0 lb	247.0 lb	181.6 cm x 79.4 cm x 133.4 cm	0.8 m ³	453.6 kg	112.0 kg	1

Mega BRUTE® Mobile Collectors

The Mega BRUTE® Mobile Collector is a highly maneuverable and versatile waste and linen collection and sortation system. Innovative design delivers improved productivity and ease of use.

- High capacity—120-gallon/400-pound capacity
- Sortation options support recycling efforts
- Highly maneuverable; fits through a standard 36" doorway and travels easily on and off most elevators
- Rear doors ease handling of heavy filled liners



Optional lid (FG9W7200) fully covers contents; center hinge allows access to either end of Mega BRUTE® Mobile Collector.



Can liner retainer secures a 55-gallon can liner and flips up for easy access to storage area.

SORTATION OPTIONS
Holds an optional 23-gallon Slim Jim® (1956188) container for improved waste sortation and recycling.

EASILY MANEUVERABLE
Large 12" wheels and 5" nonmarking lockable casters in a diamond pattern allow Mega BRUTE® Mobile Collector to turn on its own axis.

STORAGE AREA
Ideal for storing extra can liners and other cleaning supplies.



FG9W7300BLA

NO.	COLOR	DESCRIPTION	U.S. DIMENSIONS	U.S. CAPACITY	U.S. SHIP WT/CTN	METRIC DIMENSIONS	METRIC CAPACITY	METRIC SHIP WT/CTN	PACK
FG9W7300	BLA	Mega BRUTE® Mobile Collector – 1-Pack	52.5" l x 27.5" w x 42.5" h	120.0 gal	74.0 lb	133.4 cm x 69.9 cm x 108.0 cm	454.3 L	33.6 kg	1
FG9W7200	BLA	Mega BRUTE® Mobile Collector Lid	49.5" l x 30.0" w x 10.5" h	N/A	12.4 lb	125.7 cm x 76.2 cm x 26.7 cm	N/A	5.6 kg	1

Cube Trucks

A complete line of trucks for waste collection, material transport, and laundry handling, with the durability of Rotational Molding technology.

- Diamond caster pattern for easy maneuverability
- Heavy-duty utility models include metal body support band
- FG461100BLA features a spring platform option that elevates contents for easier loading and unloading



FG461673BLUE

FG461200BLA /
FG461300BLA

8-Cubic-Foot (6.4 Bushel)

NO.	COLOR	DESCRIPTION	U.S. DIMENSIONS	U.S. BUSHEL (BU)	U.S. SIZE	U.S. CAPACITY	U.S. SHIP WT/CTN	METRIC DIMENSIONS	METRIC SIZE	METRIC CAPACITY	METRIC SHIP WT/CTN	PACK
FG460800*	BLA	Cube Truck	38.0" l x 26.0" w x 28.1" h	6.4	8.0 cu ft	300.0 lb	36.3 lb	96.5 cm x 66.0 cm x 71.5 cm	0.2 m ³	136.1 kg	16.3 kg	1
FG460800D	BLUE	Cube Truck	38.0" l x 26.0" w x 28.1" h	6.4	8.0 cu ft	300.0 lb	36.3 lb	96.5 cm x 66.0 cm x 71.5 cm	0.2 m ³	136.1 kg	16.3 kg	1
FG470800*	BLA	Utility Truck, Heavy-Duty with 4" dia (10.2 cm) Casters	38.4" l x 26.0" w x 28.3" h	6.4	8.0 cu ft	700.0 lb	48.0 lb	97.5 cm x 66.0 cm x 71.8 cm	0.2 m ³	317.5 kg	21.8 kg	1
FG460900 ^A	BLA	Lid for 8 ft. ³ Cube Trucks	38.4" l x 25.8" w x 8.5" h	N/A	N/A	N/A	13.5 lb	97.5 cm x 65.4 cm x 21.6 cm	N/A	N/A	6.1 kg	1

12-Cubic-Foot (9.6 Bushel)

NO.	COLOR	DESCRIPTION	U.S. DIMENSIONS	U.S. BUSHEL (BU)	U.S. SIZE	U.S. CAPACITY	U.S. SHIP WT/CTN	METRIC DIMENSIONS	METRIC SIZE	METRIC CAPACITY	METRIC SHIP WT/CTN	PACK
FG461200*	BLA	Cube Truck	42.8" l x 28.0" w x 33.0" h	9.6	12.0 cu ft	400.0 lb	40.0 lb	108.6 cm x 71.1 cm x 83.8 cm	0.3 m ³	181.4 kg	18.1 kg	1
⑧ 1867538	BLACK	Executive Cube Truck w/ Quiet Casters	42.8" l x 28.0" w x 33.0" h	9.6	12.0 cu ft	400.0 lb	40.0 lb	108.6 cm x 71.1 cm x 83.8 cm	0.3 m ³	181.4 kg	18.1 kg	1
FG471200*	BLA	Utility Truck, Heavy-Duty with 4" dia (10.2 cm) Casters	43.3" l x 28.0" w x 33.9" h	9.6	12.0 cu ft	800.0 lb	62.3 lb	109.9 cm x 71.1 cm x 86.1 cm	0.3 m ³	362.9 kg	28.3 kg	1
FG461300 ^A	BLA	Lid for 12 ft. ³ Cube Trucks	43.1" l x 27.5" w x 8.5" h	N/A	N/A	N/A	15.1 lb	109.6 cm x 69.9 cm x 21.6 cm	N/A	N/A	6.8 kg	1

14-Cubic-Foot (11.3 Bushel)

NO.	COLOR	DESCRIPTION	U.S. DIMENSIONS	U.S. BUSHEL (BU)	U.S. SIZE	U.S. CAPACITY	U.S. SHIP WT/CTN	METRIC DIMENSIONS	METRIC SIZE	METRIC CAPACITY	METRIC SHIP WT/CTN	PACK
FG461100	BLA	Spring Platform Truck	44.1" l x 31.0" w x 32.5" h	11.3	14.0 cu ft	500.0 lb	60.0 lb	112.1 cm x 78.7 cm x 82.6 cm	0.4 m ³	226.8 kg	27.2 kg	1
FG461400*	BLA	Cube Truck	44.1" l x 31.0" w x 32.5" h	11.3	14.0 cu ft	500.0 lb	47.0 lb	112.1 cm x 78.7 cm x 82.6 cm	0.4 m ³	226.8 kg	21.3 kg	1
FG461500 ^A	BLA	Lid for 14 ft. ³ Cube Trucks	44.1" l x 31.0" w x 8.5" h	N/A	N/A	N/A	17.2 lb	112.1 cm x 78.7 cm x 21.6 cm	N/A	N/A	7.8 kg	1

16-Cubic-Foot (12.9 Bushel)

NO.	COLOR	DESCRIPTION	U.S. DIMENSIONS	U.S. BUSHEL (BU)	U.S. SIZE	U.S. CAPACITY	U.S. SHIP WT/CTN	METRIC DIMENSIONS	METRIC SIZE	METRIC CAPACITY	METRIC SHIP WT/CTN	PACK
FG461600*	BLA	Cube Truck	44.0" l x 32.0" w x 37.0" h	12.9	16.0 cu ft	500.0 lb	51.0 lb	111.1 cm x 78.7 cm x 94.0 cm	0.5 m ³	226.8 kg	23.1 kg	1
FG461600D	BLUE	Cube Truck	44.0" l x 32.0" w x 37.0" h	12.9	16.0 cu ft	500.0 lb	51.0 lb	111.1 cm x 78.7 cm x 94.0 cm	0.5 m ³	226.8 kg	23.1 kg	1
FG461673	BLUE	Recycling Cube Truck	43.8" l x 31.0" w x 37.0" h	12.9	16.0 cu ft	500.0 lb	51.0 lb	111.1 cm x 78.7 cm x 94.0 cm	0.5 m ³	226.8 kg	23.1 kg	1
⑨ 1867537	BLACK	Executive Cube Truck w/ Quiet Casters	43.8" l x 31.0" w x 37.0" h	12.9	16.0 cu ft	500.0 lb	51.0 lb	111.1 cm x 78.7 cm x 94.0 cm	0.5 m ³	226.8 kg	23.1 kg	1
FG471600*	BLA	Utility Truck, Heavy-Duty with 5" dia (12.7 cm) Casters	44.4" l x 31.0" w x 38.3" h	12.9	16.0 cu ft	1,000.0 lb	74.3 lb	112.7 cm x 78.7 cm x 97.2 cm	0.5 m ³	453.6 kg	33.7 kg	1
FG461500 ^A	BLA	Lid for 16 ft. ³ Cube Trucks	44.1" l x 31.0" w x 8.5" h	N/A	N/A	N/A	17.2 lb	112.1 cm x 78.7 cm x 21.6 cm	N/A	N/A	7.8 kg	1

20-Cubic-Foot (16.1 Bushel)

NO.	COLOR	DESCRIPTION	U.S. DIMENSIONS	U.S. BUSHEL (BU)	U.S. SIZE	U.S. CAPACITY	U.S. SHIP WT/CTN	METRIC DIMENSIONS	METRIC SIZE	METRIC CAPACITY	METRIC SHIP WT/CTN	PACK
FG461900*	BLA	Cube Truck	48.0" l x 34.1" w x 36.5" h	16.1	20.0 cu ft	600.0 lb	60.0 lb	121.9 cm x 86.7 cm x 92.7 cm	0.6 m ³	272.2 kg	27.2 kg	1
FG472000*	BLA	Utility Truck, Heavy-Duty with 5" dia (12.7 cm) Casters	48.3" l x 34.1" w x 37.9" h	16.1	20.0 cu ft	1,200.0 lb	84.8 lb	122.6 cm x 86.7 cm x 96.2 cm	0.6 m ³	544.3 kg	38.5 kg	1
FG461700 ^A	BLA	Lid for 20 ft. ³ Cube Trucks	48.5" l x 34.0" w x 8.5" h	N/A	N/A	N/A	18.8 lb	123.2 cm x 86.4 cm x 21.6 cm	N/A	N/A	8.5 kg	1

27-Cubic-Foot (21.7 Bushel)

NO.	COLOR	DESCRIPTION	U.S. DIMENSIONS	U.S. BUSHEL (BU)	U.S. SIZE	U.S. CAPACITY	U.S. SHIP WT/CTN	METRIC DIMENSIONS	METRIC SIZE	METRIC CAPACITY	METRIC SHIP WT/CTN	PACK
FG472700*	BLA	Utility Truck, Heavy-Duty with 5" dia (12.7 cm) Corner Casters	59.0" l x 34.0" w x 42.9" h	21.7	27.0 cu ft	1,200.0 lb	105.0 lb	149.9 cm x 86.4 cm x 108.9 cm	0.8 m ³	544.3 kg	47.6 kg	1
FG472600	BLA	Lid for 27 ft. ³ Cube Trucks	59.9" l x 34.5" w x 5.0" h	N/A	N/A	N/A	19.9 lb	152.1 cm x 87.6 cm x 12.7 cm	N/A	N/A	9.0 kg	1

*Pallet Pack

*FDA Compliant

When ordering products with **BOLD** color codes, please specify color code after the product number. Refer to the Standard Color Guide at the back of the catalog.

Collapsible X-Carts

Durable, easy-to-manuever cart efficiently transports large, bulky loads, then conveniently collapses to minimize storage footprint.

- Compact, collapsible frame enables efficient storage
- Durable vinyl bag accommodates bulky loads
- Easy-to-clean, detachable bag
- Color-coded ribbons classify transport materials to prevent cross-contamination
- Aesthetically pleasing black finish disguises stains and dirt
- High-quality TPR casters provide quiet operation
- Bumper guards help prevent damage to cart and facility during transport



Compact, collapsible frame reduces width by 75% to enable efficient storage.



PREMIUM QUIET CASTERS

Casters swivel for superior maneuverability, while bumper guards add extra protection during transport.

1881781



COLOR-CODED TABS

Organize your linen and/or waste collection. Select the color you wish to assign for the job and simply trim off the other three tabs.



CART COVER

Six storage pockets hold cleaning tools, gloves, clothes, spray bottles, cleaning chemicals & more!

NO.	COLOR	DESCRIPTION	U.S. DIMENSIONS	U.S. BUSHELS	U.S. SIZE	U.S. CAPACITY	U.S. SHIP WT/CTN	METRIC DIMENSIONS	METRIC SIZE	METRIC CAPACITY	METRIC SHIP WT/CTN	PACK
1881749	BLACK	Collapsible X-Cart, 4 Bushels	24.1" l x 20.3" w x 34.0" h	4.0	5.0 cu ft	220.0 lb	20.6 lb	61.2 cm x 51.6 cm x 86.4 cm	0.1 m ³	99.8 kg	9.3 kg	1
1881750	BLACK	Collapsible X-Cart, 8 Bushels	35.7" l x 24.1" w x 34.0" h	8.0	10.0 cu ft	220.0 lb	27.0 lb	95.3 cm x 61.2 cm x 86.4 cm	0.3 m ³	99.8 kg	12.2 kg	1
1881781	BLACK	Collapsible Multi-Stream X-Cart (2 x 4 Bushels)	35.7" l x 24.1" w x 34.0" h	8.0	10.0 cu ft	220.0 lb	28.6 lb	95.3 cm x 61.2 cm x 86.4 cm	0.3 m ³	99.8 kg	13.0 kg	1
1881782	BLACK	Collapsible X-Cart Replacement Bag, 4 Bushels	15.3" l x 22.4" w x 27.3" h	4.0	5.0 cu ft	220.0 lb	4.5 lb	38.9 cm x 56.9 cm x 69.3 cm	0.1 m ³	99.8 kg	2.0 kg	2
1881783	BLACK	Collapsible X-Cart Replacement Bag, 8 Bushels	30.5" l x 22.4" w x 27.3" h	8.0	10.0 cu ft	220.0 lb	6.1 lb	77.5 cm x 56.9 cm x 69.3 cm	0.3 m ³	99.8 kg	2.8 kg	2
1889863	BLACK	Collapsible X-Cart Cover, Small (for 1881749)	13.3" l x 10.8" w x 2.2" h			0.9 kg	1.9 lbs.	33.8 cm l x 27.5 cm w x 5.6 cm h	0.9 kg			1
1889864	BLACK	Collapsible X-Cart Cover, Large (for 1881750 and 1881781)	13.8" l x 8.8" w x 3.0" h			1.2 kg	2.6 lbs.	35.1 cm l x 22.4 cm w x 7.5 cm h	1.2 kg			1

Premium Linen Hamper

The Rubbermaid Commercial Premium Linen Hamper is a smart choice for large-capacity, hands-free waste collection.

- Quiet, slow-close lid contains odor and bacteria
- For use with 30-Gallon linen hamper bag with zippered front access for easy emptying (FG635000BLA)
- 2 back swivel casters and 2 fixed casters provide quiet maneuverability
- Easy-reach foot pedal allows for hands-free access
- Assists in complying with OSHA regulation 29 CFR 1910.1030 "Occupational Exposure to Bloodborne Pathogens"



FG630000



FG635000

NO.	COLOR	DESCRIPTION	U.S. DIMENSIONS	U.S. BUSHELS	U.S. SIZE	U.S. CAPACITY	U.S. SHIP WT/CTN	METRIC DIMENSIONS	METRIC SIZE	METRIC CAPACITY	METRIC SHIP WT/CTN	PACK
FG630000	BLA	Premium Linen Hamper	18.9" l x 22.7" w x 37.8" h	N/A	5.0 cu ft	N/A	14.8 lb	48.0 cm x 57.7 cm x 96.0 cm	0.1 m ³	N/A	6.7 kg	1
FG635000	BLA	Premium Linen Hamper Bag	16.5" l x 9.0" w x 14.6" h	3.2 BU	4.0 cu ft	30 gal	1.8 lb	39.4 cm x 21.6 cm x 4.4 cm	0.1 m ³	13.6 kg	0.8 kg	1



UTILITY CART SOLUTIONS

MOVE LOADS EFFICIENTLY

Ergonomically superior designed carts with integrated storage and organizational features allow users to work more efficiently. Combine that with RCP's industry-leading durability, and there's no task too tough for these carts to handle.



INTEGRATED SLOTTED V-NOTCHES

Enable safe cutting



PATENTED ERGONOMIC HANDLE

Improves cart control



DURABLE CONSTRUCTION

Helps support large loads

Heavy-Duty Adaptable Carts

The Heavy-Duty Adaptable Cart provides superior versatility for tackling whatever task is at hand. It reduces the need for time-consuming user modifications with a variety of integrated features including: an ergonomic adjustable handle with four positions for maximum comfort, a flip-up shelf, locking casters, and numerous storage features designed to help organize tools and small parts.

- Two snap-in hooks provide additional storage options for extension cords or other items with 10lb capacity
- Two fixed and two swivel locking casters included
- Flip-up shelf eliminates the need to clear top shelf contents for work space with 20lb capacity



1997208

MOVE LOADS WITH LESS EFFORT

The variable grip-height handle on our carts and trucks improves maneuverability and reduces muscle strain for most every user, regardless of height.

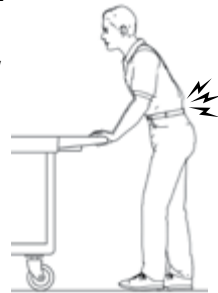

TRADITIONAL CART HANDLE DESIGN



IMPROVED VARIABLE GRIP-HEIGHT HANDLE

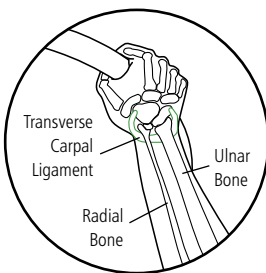

Angled handle helps keep wrist and bones in forearm aligned for optimum leverage while turning.



NO.	COLOR	DESCRIPTION	U.S. DIMENSIONS	U.S. CAPACITY	U.S. SHIP WT/CTN	METRIC DIMENSIONS	METRIC CAPACITY	METRIC SHIP WT/CTN	CASTER TYPE	PACK
1997206	BLACK	Small Heavy-Duty Adaptable Cart	46.2" l x 17.8" w x 36.0" h	500.0 lb	37.2 lb	117.3 cm x 45.1 cm x 91.4 cm	226.8 kg	16.9 kg	5.0" TPR	1
1997208	BLACK	Medium Heavy-Duty Adaptable Cart	51.5" l x 25.2" w x 36.0" h	500.0 lb	49.0 lb	130.7 cm x 64.0 cm x 91.4 cm	226.8 kg	22.2 kg	5.0" TPR	1
FG459300	RED	Extension Drawer	17.0" l x 25.0" w x 4.7" h	N/A	12.3 lb	43.2 cm x 63.5 cm x 11.9 cm	N/A	5.6 kg	N/A	1
1997371	N/A	5" Replacement Caster Set (Locking)	5.7" l x 2.6" w x 5.8" h	N/A	4.6 lb	14.5 cm x 6.5 cm x 14.8 cm	N/A	2.1 kg	5.0" TPR	1
FG459200	0000	8" Replacement Caster Set	18.8" l x 12.6" w x 10.4" h	N/A	25.6 lb	47.8 cm x 31.9 cm x 26.4 cm	N/A	11.6 kg	8.0" Pneumatic	1

Heavy-Duty Utility Carts

Transport materials, supplies, and heavy loads securely in almost any environment.

- All BRUTE® Heavy Duty Ergonomic Utility Carts are backed by a category leading 10-year limited warranty
- Available in lipped-shelf or flat-shelf models
- Easy to clean—maintenance free

Lipped-Shelf models feature:

- Integrated V-notch to hold pipe and conduit securely for safe cutting
- Deep pocket shelves to keep loads secure

Flat-Shelf models feature:

- Large, flat top shelf for oversize loads and smarter work surface
- Lower pocket shelf to keep loads secure

4-Shelf Ergo Utility model features:

- 13.5" clearance between shelves allows easy access to items
- Patented ergonomic handles that improve control and worker safety

KEEP LOADS SECURE

Deep pocket shelves keep contents in place.

STRUCTURAL FOAM CONSTRUCTION

Durable structural foam construction won't leak, rust, chip, dent, or peel.



FG452089



2196862



2128657



FG452088BLA

ACCESSORIZE AND CUSTOMIZE TO MEET YOUR NEEDS



FG335488
4-GALLON
UTILITY BIN



FG335388
8-GALLON
REFUSE BIN



FG459300 SINGLE FULL
EXTENSION DRAWER
(see Cart Accessories)



FG9G6000
SMALL
INGREDIENT BIN



FG334900
BUS/UTILITY BOX



FG172100
1.3 CU FT PALLETOTE

When ordering products with **BOLD** color codes, please specify color code after the product number. Refer to the Standard Color Guide at the back of the catalog.



2-Shelf Lipped Carts

NO.	COLOR	DESCRIPTION	U.S. DIMENSIONS	U.S. CAPACITY	U.S. SHIP WT/CTN	METRIC DIMENSIONS	METRIC CAPACITY	METRIC SHIP WT/CTN	CASTER TYPE	PACK
FG450088	BLA, BEIG	BRUTE Ergo Handle Utility Cart (Small)	39.0" l x 17.9" w x 33.3" h	500.0 lb	30.8 lb	99.1 cm x 45.4 cm x 84.5 cm	226.8 kg	14.0 kg	5.0" TPR	1
FG452088	BLA, BEIG	BRUTE Ergo Handle Utility Cart (Med)	44.0" l x 25.3" w x 39.0" h	500.0 lb	42.8 lb	111.8 cm x 64.1 cm x 99.1 cm	226.8 kg	19.4 kg	5.0" TPR	1
2192464	GRAY	BRUTE Ergo Handle Utility Cart (Med)	44.0" l x 25.3" w x 39.0" h	500.0 lb	42.8 lb	111.8 cm x 64.1 cm x 99.1 cm	226.8 kg	19.4 kg	5.0" TPR	1
FG452010	BLA	BRUTE Ergo Handle Utility Cart (Med) with Pneumatic Casters	45.3" l x 25.9" w x 37.1" h	500.0 lb	63.0 lb	114.9 cm x 65.7 cm x 94.3 cm	226.8 kg	28.6 kg	8.0" Pneumatic	1
FG454600	BLA	BRUTE Ergo Handle Utility Cart (Large)	55.0" l x 26.0" w x 33.3" h	750.0 lb	52.4 lb	139.7 cm x 66.0 cm x 84.5 cm	340.2 kg	23.8 kg	5.0" TPR	1
2192463	GRAY	BRUTE Ergo Handle Utility Cart (Large)	55.0" l x 26.0" w x 33.3" h	750.0 lb	52.4 lb	139.7 cm x 66.0 cm x 84.5 cm	340.2 kg	23.8 kg	5.0" TPR	1
FG454610	BLA	BRUTE Ergo Handle Utility Cart (Large) with Pneumatic Casters	55.0" l x 26.0" w x 33.3" h	750.0 lb	71.0 lb	139.7 cm x 66.0 cm x 84.5 cm	340.2 kg	32.2 kg	8.0" Pneumatic	1
FG450089	BLA	Flat Handle Utility Cart (Small)	39.0" l x 17.9" w x 33.3" h	500.0 lb	31.1 lb	99.1 cm x 45.4 cm x 84.5 cm	226.8 kg	14.1 kg	5.0" TPR	1
FG452089	BLA, BEIG	Flat Handle Utility Cart (Med)	45.3" l x 25.9" w x 33.3" h	500.0 lb	44.7 lb	114.9 cm x 65.7 cm x 84.5 cm	226.8 kg	20.3 kg	5.0" TPR	1
FG9T6600*	BLA	Flat Handle Utility Cart (Small) with 5" Casters	34.3" l x 17.4" w x 31.5" h	500.0 lb	30.8 lb	87.0 cm x 44.1 cm x 80.0 cm	226.8 kg	14.0 kg	5.0" (12.7 cm)	12
FG9T6700*	BLA	Flat Handle Utility Cart (Med) with 5" Casters	40.3" l x 25.6" w x 32.5" h	500.0 lb	42.8 lb	102.2 cm x 65.1 cm x 82.6 cm	226.8 kg	19.4 kg	5.0" (12.7 cm)	10

*Pallet Pack

2-Shelf Flat Carts

NO.	COLOR	DESCRIPTION	U.S. DIMENSIONS	U.S. CAPACITY	U.S. SHIP WT/CTN	METRIC DIMENSIONS	METRIC CAPACITY	METRIC SHIP WT/CTN	CASTER TYPE	PACK
FG450500	BLA	BRUTE Ergo Handle Utility Cart (Small)	37.9" l x 19.2" w x 33.3" h	500.0 lb	29.5 lb	96.2 cm x 48.8 cm x 84.6 cm	226.8 kg	13.4 kg	5.0" TPR	1
FG452500	BLA	BRUTE Ergo Handle Utility Cart (Med)	43.9" l x 25.9" w x 33.3" h	500.0 lb	41.0 lb	111.5 cm x 65.7 cm x 84.6 cm	226.8 kg	18.6 kg	5.0" TPR	1
FG454500	BLA	BRUTE Ergo Handle Utility Cart (Large)	54.0" l x 25.3" w x 36.0" h	750.0 lb	52.4 lb	137.2 cm x 64.1 cm x 91.4 cm	340.2 kg	23.8 kg	5.0" TPR	1
FG450589	BLA	Flat Handle Utility Cart (Small)	37.9" l x 19.2" w x 33.3" h	500.0 lb	29.5 lb	96.2 cm x 48.8 cm x 84.6 cm	226.8 kg	13.4 kg	5.0" TPR	1
FG452589	BLA	Flat Handle Utility Cart (Med)	43.9" l x 25.9" w x 33.3" h	500.0 lb	41.0 lb	111.5 cm x 65.7 cm x 84.6 cm	226.8 kg	18.6 kg	5.0" TPR	1

3-Shelf Carts

NO.	COLOR	DESCRIPTION	U.S. DIMENSIONS	U.S. CAPACITY	U.S. SHIP WT/CTN	METRIC DIMENSIONS	METRIC CAPACITY	METRIC SHIP WT/CTN	CASTER TYPE	PACK
2203280	BLA	BRUTE Ergo Handle Flat-Shelf Utility Cart (Small)	38.4" l x 25.2" w x 46.2" h	600.0 lb	43.8 lb	97.5 cm x 64.0 cm x 117.3 cm	272.2 kg	19.5 kg	5.0" TPR	1
2196862	BLA	BRUTE Ergo Handle Lipped-Shelf Utility Cart (Med)	44.0" l x 25.2" w x 47.0" h	600.0 lb	55.6 lb	111.8 cm x 64.0 cm x 119.4 cm	272.2 kg	25.2 kg	5.0" TPR	1

4-Shelf Cart

NO.	COLOR	DESCRIPTION	U.S. DIMENSIONS	U.S. CAPACITY	U.S. SHIP WT/CTN	METRIC DIMENSIONS	METRIC CAPACITY	METRIC SHIP WT/CTN	CASTER TYPE	PACK
2128657	BLA	BRUTE Ergo Handle Lipped-Shelf Utility Cart (Large)	54.1" l x 24.3" w x 62.4" h	700.0 lb	102.0 lb	294.2 cm x 140.5 cm x 67.3 cm	317.5 kg	46.3 kg	5.0" TPR	1

UTILITY REFUSE AND RECYCLING

DECORATIVE REFUSE

CLEANING

MATERIAL HANDLING

WASHROOM

FOODSERVICE

ACCESSORIES & INDEX



Trades Carts

Moves productivity right to the worksite—a complete tool storage and mobile workbench system.

- Four compartmentalized boxes for storing assorted parts and hardware
- Fully enclosed, lockable storage compartment helps keep tools and materials secure (FG618088)
- Two storage bins hold essential hand tools and supplies
- Carts move easily over hard surfaces and through elevators and doorways
- Flat surface at user-friendly height provides convenient work area
- Nonmarking 5" casters for easy mobility
- Optional Refuse Bin (FG335388) and Utility Bin (FG335488)



FG618088BLA

Convenient lockable cabinet



FG618088BLA

Four compartment drawers for assorted parts



FG618000BLA



FG618088BLA

For Optional Refuse Bin (FG335388) and Utility Bin (FG335488), see page 179.

NO.	COLOR	DESCRIPTION	U.S. DIMENSIONS	U.S. CAPACITY	U.S. SHIP WT/CTN	METRIC DIMENSIONS	METRIC CAPACITY	METRIC SHIP WT/CTN	PACK
FG618000	BLA	Trades Cart with 5" (12.7 cm) Casters includes 2 parts boxes and 4 parts bins	38.0" l x 19.3" w x 33.4" h	180.0 lb top shelf, 150.0 lb bottom shelf	50.3 lb	96.5 cm x 48.9 cm x 84.8 cm	81.6 kg top shelf, 68.0 kg bottom shelf	22.8 kg	1
FG618088	BLA	Trades Cart with Locking Cabinet includes 2 parts boxes and 4 parts bins	38.0" l x 19.3" w x 33.4" h	180.0 lb top shelf, 150.0 lb bottom shelf	68.0 lb	96.5 cm x 48.9 cm x 84.8 cm	81.6 kg top shelf, 68.0 kg bottom shelf	30.8 kg	1

5-Drawer Mobile Work Center

Heavy-duty work surface supports up to 250 lbs.

- Built-in cord wrap provides neat, convenient storage of power tools and work lights
- Casters allow easy maneuverability and are lockable
- Locking bar provides security and keeps drawers from sliding open during transport
- Pegboard side panels provide convenient tool organization



NO.	COLOR	DESCRIPTION	U.S. DIMENSIONS	U.S. CAPACITY	U.S. SHIP WT/CTN	METRIC DIMENSIONS	METRIC CAPACITY	METRIC SHIP WT/CTN	PACK
FG773488	BLA	5-Drawer Mobile Work Center	32.6" l x 19.9" w x 33.5" h	250.0 lb	69.0 lb	82.9 cm x 50.5 cm x 85.1 cm	113.4 kg	31.3 kg	1

When ordering products with **BOLD** color codes, please specify color code after the product number. Refer to the Standard Color Guide at the back of the catalog.

TradeMaster® Mobile Cabinets and Work Centers

Easily transport tools and supplies where you need them.

- Features locking cabinet doors and 4" deep drawers for versatile tool and supply storage and organization
- Drawers feature commercial-quality, ball-bearing slides
- Metal-reinforced structural foam shelves engineered for durability
- Arrives 90% assembled



FG451388BLA



FG453388BLA

NO.	COLOR	DESCRIPTION	U.S. DIMENSIONS	U.S. CAPACITY	U.S. SHIP WT/CTN	METRIC DIMENSIONS	METRIC CAPACITY	METRIC SHIP WT/CTN	PACK
FG451388	BLA	TradeMaster® Cart with 4 Drawers	40.6" l x 18.4" w x 33.4" h	500.0 lb	86.9 lb	103.2 cm x 46.7 cm x 84.8 cm	226.8 kg	39.4 kg	1
FG453388	BLA	TradeMaster® Cart with 4 Drawers and Cabinet, Small	49.0" l x 26.3" w x 38.0" h	750.0 lb	123.0 lb	124.5 cm x 66.7 cm x 96.5 cm	340.2 kg	55.8 kg	1

Convertible Utility Cart

Converts from a utility cart to a platform truck in just seconds.

- Innovative design
- Multifunctional productivity with improved worker well-being—saving you time and money



PUSH BUTTONS

Depress buttons to easily convert from utility cart to platform truck.



LOCKING CASTERS

Rear wheel locks keep cart in place while loading and unloading.



FOOT PEDAL

Depress foot pedal to fold cart for storage.



FOLDS FROM 34³/₈" TO 10⁷/₈" FOR EASY STORAGE

QUICK CONVERSION

Easily converts from a utility cart into a platform truck and then folds flat for storage.



UTILITY CART



PLATFORM TRUCK



34³/₈" High

10⁷/₈" High

NO.	COLOR	DESCRIPTION	U.S. DIMENSIONS	U.S. CAPACITY	U.S. SHIP WT/CTN	METRIC DIMENSIONS	METRIC CAPACITY	METRIC SHIP WT/CTN	PACK
FG430000	BLA	Convertible Utility Cart	45.2" l x 23.8" w x 34.4" h (Utility)	400.0 lb	52.0 lb	115.0 cm x 60.5 cm x 87.4 cm (Utility)	181.0 kg	23.6 kg	1



Executive Series™ Service Cart

The Executive Series™ Service Cart is an elegant and versatile solution for back- and front-of-house tasks. With 20% more top-shelf capacity, it's constructed of durable, recyclable polyethylene, and it's easy to clean—keeping your business looking smart for years.

ERGONOMIC ROUNDED HANDLES
Improves maneuverability and comfort.

WRAPAROUND END PANELS
Conceals cart contents.

SOLID ROUNDED BUMPER
Gentle on walls and furniture.

300-LB LOAD CAPACITY
Holds 100 lbs per shelf.



FG9T6800BLA



FG9T6800BLA

ATTRACTIVE STYLING
Ideal for front-of-house use.



FG9T6800BLA /
FG335488BLA /
FG334900GRAY

INCREASED CAPACITY
Accommodates two standard bus boxes on top shelf.

NO.	COLOR	DESCRIPTION	U.S. DIMENSIONS	U.S. CAPACITY	U.S. SHIP WT/CTN	METRIC DIMENSIONS	METRIC CAPACITY	METRIC SHIP WT/CTN	PACK
⑥ FG9T6800	BLA	Executive Service Cart	39.0" l x 21.0" w x 38.0" h	300.0 lbs	31.5 lb	99.1 cm x 53.3 cm x 96.5 cm	136.0 kg	14.3 kg	1

Accessories

NO.	COLOR	DESCRIPTION	U.S. DIMENSIONS	U.S. CAPACITY	U.S. SHIP WT/CTN	METRIC DIMENSIONS	METRIC CAPACITY	METRIC SHIP WT/CTN	PACK
FG335388	BLA	Refuse Bin	12.0" l x 17.0" w x 22.0" h	8.0 gal	9.0 lb	30.5 cm x 43.2 cm x 55.9 cm	30.3 L	4.1 kg	2
FG335488	BLA	Utility Bin	12.1" l x 17.0" w x 10.5" h	4.0 gal	5.4 lb	30.8 cm x 43.2 cm x 26.7 cm	15.1 L	2.4 kg	2
FG334900 ^a	WHT, GRAY	Bus/Utility Box	20.0" l x 15.0" w x 5.0" h	4.6 gal	20.6 lb	50.8 cm x 38.1 cm x 12.7 cm	17.5 L	9.3 kg	12

^aCertified to NSF Standard #2 for food contact.

When ordering products with **BOLD** color codes, please specify color code after the product number. Refer to the Standard Color Guide at the back of the catalog.

Service Carts

Versatile, durable carts perform a wide variety of tasks.

- Molded shelves won't rust, dent, or require painting
- Easy-to clean, smooth surfaces
- Convenient handles and compact size enhance maneuverability
- Assists in complying with HACCP guidelines
- Nonmarking swivel casters reduce touch-up cleaning



FG342100



FG342488



FG345700

NO.	COLOR	DESCRIPTION	U.S. DIMENSIONS	U.S. CAPACITY	U.S. SHIP WT/CTN	METRIC DIMENSIONS	METRIC CAPACITY	METRIC SHIP WT/CTN	PACK
FG342100	BLA	Utility Cart with 3" dia (7.6 cm) Swivel Casters and End Panels	33.6" l x 18.6" w x 36.6" h	150.0 lb	34.0 lb	85.4 cm x 47.3 cm x 93.0 cm	68.0 kg	15.4 kg	1
FG342488	PLAT, OWHT, BLA	Utility Cart with 4" dia (10.2 cm) Swivel Casters	33.6" l x 18.6" w x 37.8" h	200.0 lb	30.0 lb	85.4 cm x 47.3 cm x 95.9 cm	90.7 kg	13.6 kg	1
FG345700	BLA	Utility Cart with Lockable Doors, Sliding Drawer, and 4" dia (10.2 cm) Swivel Casters	33.6" l x 18.6" w x 37.8" h	200.0 lb	44.8 lb	85.4 cm x 47.3 cm x 95.9 cm	90.7 kg	20.3 kg	1

Xtra™ Carts

Durable and attractive carts storage and transportation for front- and back-of-house applications.

- Metal uprights and molded shelves engineered for durability and appearance
- Nonmarking 4" swivel casters
- Wide shelves hold a variety of equipment and supplies, up to 300 lbs
- Available with locking doors and enclosure panels



FG409300



FG409400



FG409500



FG409600

NO.	COLOR	DESCRIPTION	U.S. DIMENSIONS	U.S. CAPACITY	U.S. SHIP WT/CTN	METRIC DIMENSIONS	METRIC CAPACITY	METRIC SHIP WT/CTN	PACK
FG409100	OWHT, GRAY, BLA	Utility Cart, Open-Sided	40.6" l x 20.0" w x 37.8" h	300.0 lb	43.4 lb	103.2 cm x 50.8 cm x 96.0 cm	136.1 kg	19.7 kg	1
FG409300	BLA	Utility Cart with Enclosed End Panels on 3 Sides	40.6" l x 20.0" w x 37.8" h	300.0 lb	51.6 lb	103.2 cm x 50.8 cm x 96.0 cm	136.1 kg	23.4 kg	1
FG409400	GRAY	Instrument Cart with Lockable Doors and Sliding Drawers	40.6" l x 20.0" w x 37.8" h	300.0 lb	52.0 lb	103.2 cm x 50.8 cm x 96.0 cm	136.1 kg	23.6 kg	1
FG409500	BLA	Equipment Cart	40.6" l x 20.8" w x 37.8" h	300.0 lb	58.5 lb	103.2 cm x 52.7 cm x 96.0 cm	136.1 kg	26.5 kg	1
FG409600	BLA	4-Shelf Cart, Open-Sided	40.6" l x 20.0" w x 51.0" h	300.0 lb	52.0 lb	103.2 cm x 50.8 cm x 129.5 cm	136.1 kg	23.6 kg	1



2154629

DURAMOLD™ REAL WORLD RUGGED — TESTED TOUGH

Rubbermaid's exclusive Duramold™ technology exceeds the highest performance standards in the industry. We test and retest our products to meet rigorous durability standards, and our material handling products are no exception. Real-world rugged durability, innovative technology, and best-in-class features combine to create longer-lasting products that carry heavy loads—and make your work easier.

WILL NOT WARP, DENT, SPLINTER, RUST, OR ROT

Tough, resilient surface absorbs impact and provides quiet operation. Virtually maintenance-free; resistant to most chemicals, impervious to water damage, and easily cleaned.



Metal—dents and rusts



Wood—splinters and rots

40 buckets of sheetrock compound
weigh over 2,400 lbs

DURAMOLD™
precision-engineered resin and
steel composite decks
HOLD & TRANSPORT UP TO

2500 lbs.

of weight load capacity

Duramold™ decks are formed from a precision-engineered resin and metal composite structure that is lighter than typical steel/wood products without sacrificing strength, which enables weight reduction and improved ergonomics.



**PUT YOUR EFFORT INTO
MOVING YOUR PAYLOAD,
NOT YOUR TRUCK**

**DURAMOLD™ HAS THE
HIGHEST STRENGTH-TO-
WEIGHT RATIO**

when compared to metal, wood,
and solid plastic decks.

Heavy-Duty Platform Trucks

Ideal for moving large, heavy, oversized loads in a variety of environments from retail to construction.

DURAMOLD

DECK SIZES:

- 24" X 36"
- 24" X 48"
- 30" X 60"

CAPACITY RANGE (lbs)

1000-2500

IMPROVED MANEUVERABILITY
Variable grip-height handle improves control.

VIRTUALLY MAINTENANCE-FREE
Powder-coated steel creates a hard finish that is far tougher than conventional paint.

BUILT-IN SAFETY FEATURES
Retainer clips prevent unintended handle removal.

SECURE SMALL ITEMS
Perimeter deck channel retains small items.

KEEP LOADS IN PLACE
Textured deck surface reduces load slippage.

RUGGED CONSTRUCTION
Duramold's™ exclusive, precision-engineered resin and metal composite structure provides maximum load support.

BETTER LOAD RETENTION
Four molded-in tie-down slots for securing loads with tie-down straps or bungees.

FG440300



Three-position handle provides better mobility and convenient storage.



Platform Trucks

NO.	COLOR	DESCRIPTION	U.S. DIMENSIONS	U.S. CAPACITY	U.S. SHIP WT/CTN	METRIC DIMENSIONS	METRIC CAPACITY	METRIC SHIP WT/CTN	CASTER TYPE	PACK
FG440300	BLA	Heavy-Duty Platform Truck	36.0" l x 24.0" w	1,000.0 lb	50.0 lb	91.4 cm x 61.0 cm	453.6 kg	22.7 kg	6.0" TPR	1
FG440600	BLA	Heavy-Duty Platform Truck	36.0" l x 24.0" w	2,000.0 lb	50.0 lb	91.4 cm x 61.0 cm	907.2 kg	22.7 kg	6.0" Polyolefin	1
FG443600	BLA	Heavy-Duty Platform Truck (Med 24" x 48")*	48.0" l x 24.0" w	2,000.0 lb	70.0 lb	121.9 cm x 61.0 cm	907.2 kg	31.8 kg	8.0" TPR	1
FG443610	BLA	Heavy-Duty Platform Truck*	48.0" l x 24.0" w	1,200.0 lb	75.0 lb	121.9 cm x 61.0 cm	544.3 kg	34.0 kg	8.0" Pneumatic	1
FG444100	BLA	Heavy-Duty Platform Truck*	48.0" l x 24.0" w	2,500.0 lb	69.0 lb	121.9 cm x 61.0 cm	1,134.0 kg	31.3 kg	8.0" Polyolefin	1
FG446600	BLA	Heavy-Duty Platform Truck*	60.0" l x 30.0" w	2,000.0 lb	87.9 lb	152.4 cm x 76.2 cm	907.2 kg	39.9 kg	8.0" TPR	1
FG447100	BLA	Heavy-Duty Platform Truck*	60.0" l x 30.0" w	2,500.0 lb	84.0 lb	152.4 cm x 76.2 cm	1,134.0 kg	38.1 kg	8.0" Polyolefin	1
FG440000	BLA	Triple® Trolley, Utility-Duty with Straight Handle and 3" (7.6 cm) Casters	32.5" l x 20.5" w	250.0 lb	20.6 lb	82.6 cm x 52.1 cm	113.4 kg	9.3 kg	1.0	1
FG440100	BLA	Triple® Trolley, Standard Duty with User-Friendly Handle and 5" dia x .875" w (12.7 cm x 2.22 cm) Casters	32.5" l x 20.5" w	500.0 lb	25.4 lb	82.6 cm x 52.1 cm	226.8 kg	11.5 kg	1.0	1

* Compatible with Retrofit Motorized Kit for Platform Trucks.





Centralized control system includes variable speed control, handbrake for quick stop, and key for authorized use only.



Dual onboard battery compartment provides back-up power storage without having to plug in the entire truck.



Motorized drive wheels reduce the effort needed to move up to 1,000 lbs.

Platform Truck Motorized Kits and Accessories

NO.	COLOR	DESCRIPTION	U.S. DIMENSIONS	U.S. CAPACITY	U.S. SHIP WT/CTN	METRIC DIMENSIONS	METRIC CAPACITY	METRIC SHIP WT/CTN	PACK
2173663	BLACK	Motorized Kit For Platform Truck Med 24" x 48" ¹	48.0" l x 24.0" w	1,000.0 lb	100.5 lb	121.9 cm x 60.9 cm	453.6 kg	31.7 kg	1
2173661	BLACK	Motorized Kit For Platform Truck Large 30" x 60" ¹	60.0" l x 30.0" w	1,000.0 lb	133.7 lb	160 cm x 762 cm	453.6 kg	60.6 kg	1
2173664	BLACK	Motorized Kit Universal Battery	6.8" l x 4.8" w x 3.5" h	N/A	4.3 lb	17.1 cm x 12.1 cm x 8.3 cm	N/A	1.9 kg	1
2173520	BLACK	Motorized Kit Charger	6.3" l x 7.3" w x 2.3" h	N/A	1.5 lb	15.9 cm x 18.4 cm x 5.7 cm	N/A	0.8 kg	1

¹ Includes one 60V battery and one 3Ah charger, and wheel set. Platform truck sold separately.

When ordering products with **BOLD** color codes, please specify color code after the product number. Refer to the Standard Color Guide at the back of the catalog.

Towable Pallet Cart & Platform Truck

Increase productivity by moving more...faster.

- Tow up to 3 carts at once using the heavy-duty tow bar and hitch.
- Duramold™ Deck is lighter than typical steel/wood products
- Pallet Cart features four pallet retainers to secure standard pallets in place up to a standard 48" x 48" pallet
- Handle designed with variable grip heights to suit a wide range of user heights
- Convenient molded in tie-down slots allow users to secure loads with straps or bungees



2154626



2154629



2154626

NO.	COLOR	DESCRIPTION	U.S. DIMENSIONS	U.S. CAPACITY	U.S. SHIP WT/CTN	METRIC DIMENSIONS	METRIC CAPACITY	METRIC SHIP WT/CTN	CASTER TYPE	PACK
2154626	BLACK	Towable Pallet Cart (50" x 50")	54.5" l x 51.0" w x 42.5" h	2,500.0 lb	154.0 lb	138.4 cm x 129.5 cm x 108.0 cm	1,134.0 kg	69.9 kg	8.0" Polyolefin	1
2154629	BLACK	Towable Platform Truck (30" x 60")	64.3" l x 30.5" w x 42.5" h	2,500.0 lb	91.5 lb	163.2 cm x 77.5 cm x 108.0 cm	1,134.0 kg	41.5 kg	8.0" Polyolefin	1

Sheet and Panel Truck

Transport large, bulky sheet goods and hard-to-handle loads such as doors, lumber, drywall, tables, and cubicle walls.

**MOVE HARD-TO-HANDLE LOADS**

Three removable powder-coated steel vertical frames provide support for bulky loads. Frames can be removed as needed based on load requirements.

HOLDS SHEET GOODS SECURELY

High-side frame and side rail hold load firmly in place during transit.

KEEP LOADS IN PLACE

Textured deck surface reduces load slippage.

BUILT-IN SAFETY FEATURES

Retainer clips lock frames securely in place and prevent unintended removal. Four tie-down points, two on each side, help with load retention.

**RUGGED CONSTRUCTION**

Duramold's™ exclusive, precision-engineered resin and metal composite structure provides maximum load support.

NO.	COLOR	DESCRIPTION	U.S. DIMENSIONS	U.S. CAPACITY	U.S. SHIP WT/CTN	METRIC DIMENSIONS	METRIC CAPACITY	METRIC SHIP WT/CTN	CASTER TYPE	PACK
FG446800	BLA	Sheet and Panel Truck (24" x 48")	47.9" l x 24.3" w x 39.9" h	2,000.0 lb	98.0 lb	121.7 cm x 61.6 cm x 101.3 cm	907.2 kg	44.5 kg	8.0" Polyolefin	1

When ordering products with **BOLD** color codes, please specify color code after the product number. Refer to the Standard Color Guide at the back of the catalog.

Side-Panel Platform Truck

Ideal for transporting small packages and materials.



ENHANCE USER COMFORT
Side panel cutouts allow easy access to load.

3" X 3" GRID SIDE PANELS
Heavy-duty wire side panels retain small packages and items.

BUILT-IN SAFETY FEATURES
Retainer clips prevent unintended handle removal.

CUSTOMIZABLE
Remove one, two, three, or all four side panels to accommodate any size load.

RUGGED CONSTRUCTION
Duramold's™ exclusive, precision-engineered resin and metal composite structure provides maximum load support.

BETTER LOAD RETENTION
Molded-in tie-down slots increase load security. Textured deck surface reduces load slippage.

NO.	COLOR	DESCRIPTION	U.S. DIMENSIONS	U.S. CAPACITY	U.S. SHIP WT/CTN	METRIC DIMENSIONS	METRIC CAPACITY	METRIC SHIP WT/CTN	CASTER TYPE	PACK
FG448600	BLA	Side-Panel Platform Truck (24" x 48")	56.0" l x 24.3" w x 41.3" h	2,000.0 lb	105.0 lb	142.2 cm x 61.6 cm x 104.8 cm	907.2 kg	47.6 kg	8.0" TPR	1

IMPROVE FULFILLMENT EFFICIENCY

The efficiency of order fulfillment is becoming increasingly important in distribution centers. E-commerce customers continue to expect faster delivery times. With three slanted shelves, the Tote Picking Cart is up to 30% more efficient, allowing for quicker order fulfillment time.*



DURABLE STEEL CONSTRUCTION

Built to withstand the high demands of commercial use.

ERGONOMIC HANDLE

Reduce user strain allowing for easy movement.

TOTE STORAGE ACCESSORY

Reduce time spent searching for totes.

UTILITY & REFUSE BIN

Add utility or refuse bins to increase storage of scanners, sanitizer, etc.

NON-MARKING BUMPERS

Prevent product damage and reduce workplace accidents.

ANGLED SHELVES

Increased visibility for more accurate picking and reduced errors. Pick directly into angled totes, eliminating steps.

SWIVEL CASTERS

2 Fixed and 2 Locking Swivel 4" Casters make maneuvering in tight spaces and crowded aisles easy.

* Based on third-party time study results vs. RCP Medium Lipped 2-Shelf Utility Cart (FG9T6700BLA)

Tote Picking Cart and Accessories

Ideal for transporting small packages and materials.

- Angled shelf design offers clear visibility to stowed items, which helps reduce errors in the picking process
- On-board tote storage reduces time spent locating totes and allows for more time on other tasks
- Multiple shelf design helps minimize bending and lifting while the handle was designed with ergonomics in mind
- Fits up to 9 of FG172100GRAY and 6 of FG173100GRAY



Tote Picking Cart

NO.	COLOR	DESCRIPTION	U.S. DIMENSIONS	U.S. CAPACITY	U.S. SHIP WT/CTN	METRIC DIMENSIONS	METRIC CAPACITY	METRIC SHIP WT/CTN	CASTER TYPE	PACK
2144269	RED	Tote Picking Cart	57.0" l x 18.5" w x 55.0" h	450.0 lb	76.0 lb	147.6 cm x 56.8 cm x 33.3 cm	30.4 kg	34.5 kg	4.0" TPR	1



2144270



FG172100GRAY



FG173100GRAY



FG335388BLA



FG335488BLA

Accessories

NO.	COLOR	DESCRIPTION	U.S. DIMENSIONS	U.S. SHIP WT/CASE	METRIC DIMENSIONS	METRIC SHIP WT/CASE	CASE PACK
2144270	RED	Tote Storage Bracket	22.6" l x 22.1" w x 9.9" h	14.2 lbs	67.6 cm x 56.2 cm x 25.1 cm	6.4 kg	1
FG172100	GRAY	Palletote — 1.3 ft ³	19.5" l x 15.5" w x 10.0" h	41.1 lbs	49.5 cm x 39.4 cm x 25.4 cm	18.6 kg	10
FG173100	GRAY	Palletote — 2.0 ft ³	23.8" l x 19.8" w x 10.0" h	60.6 lbs	60.3 cm x 50.2 cm x 25.4 cm	27.5 kg	10
FG335388	BLA	8 Gallon Refuse Bin	14.5" l x 12.0" w x 21.0" h	8.6 lbs	36.8 cm x 30.5 cm x 53.3 cm	3.9 kg	2
FG335488	BLA	Utility Bin	16.5" l x 12.5" w x 10.0" h	5.2 lbs	41.9 cm x 31.8 cm x 25.4 cm	2.3 kg	2

Digital Receiving Utility Scales

Proper inventory control begins at the receiving door.

DIGITAL RECEIVING SCALE

- Rugged 18-gauge scale designed to handle heavy packages and containers
- Remote 1/2" LCD wall-mount display saves counter space and provides eye-level readout (9' cord reach) for employee-safe receiving
- Tare feature removes weight of container
- Low-profile, nonskid platform allows for easy weighing



FG401088 / FG404088

NO.	DESCRIPTION	INCREMENTS	U.S. CAPACITY	U.S. SHIP WT/CTN	METRIC CAPACITY	METRIC SHIP WT/CTN	CASE PACK
FG401088	Digital Receiving Scale	0.2 lb, 0.1 kg	150.0 lb	22.0 lb	68.0 kg	10.0 kg	2
FG404088	Digital Receiving Scale	0.5 lb, 0.2 kg	400.0 lb	22.0 lb	180.0 kg	10.0 kg	2

CASTERS TO MEET YOUR NEEDS

Rubbermaid's best-in-class heavy-duty casters have been specially chosen for each of our products to meet your most demanding environments.

**THERMOPLASTIC RUBBER**

TPR casters absorb shock, provide floor surface protection, and quiet operation. Chemical- and water-resistant.

**POLYOLEFIN**

Hard-tread polyolefin casters roll easier than soft tread casters. Nonmarking, impact- and chemical-resistant casters won't flat-spot under static loads or pick up metal shavings, nails, and other debris.

**PNEUMATIC**

Pneumatic casters provide a cushioned and quiet ride for fragile loads, making them ideal for rough and uneven surfaces, inside and out.

CASTER PERFORMANCE GUIDE

	CASTER TREAD MATERIAL	MOLD-ON RUBBER (TPR)	POLYOLEFIN	PNEUMATIC
FLOOR SURFACE	ASPHALT	Excellent	Fair	Excellent
	BRICK	Excellent	Fair	Excellent
	CARPET	Excellent	Good	Excellent
	CONCRETE	Excellent	Good	Excellent
	LINOLEUM / COMPOSITION TILE	Excellent	Fair	Excellent
	STEEL – RIBBED	Good	Fair	Excellent
	STEEL – SMOOTH	Good	Good	Excellent
	TERRAZZO	Excellent	Fair	Excellent
	WOOD	Excellent	Good	Excellent
OPERATING CONDITIONS	MILD CHEMICALS	Fair	Good	Good
	HARSH CHEMICALS	Fair	Fair	Good
	METAL SCRAPS – SMALL	Excellent	Good	Good
	METAL SCRAPS – LARGE	Excellent	Fair	Good
	ANIMAL FATS	Good	Good	Good
	OIL AND GREASE	Fair	Good	Fair
	WATER AND STEAM	Good	Excellent	Good
OTHER FACTORS	FLOOR PROTECTION	Excellent	Good	Excellent
	QUIET OPERATION	Excellent	Fair	Excellent
	CUSHION LOAD	Excellent	N/A	Excellent
	IMPACT RESISTANCE	Excellent	Good	Excellent
	ROLLING EASE	Fair	Excellent	Fair
	ABRASION RESISTANCE (NONCHIPPING)	Fair	Good	Fair
	NON-FLAT-SPOTTING (UNDER STATIC LOAD)	Fair	Excellent	N/A

When ordering products with **BOLD** color codes, please specify color code after the product number. Refer to the Standard Color Guide at the back of the catalog.

Cart Accessories



FG335388



FG459300



FG335488



FG459200

CART NO.	FG335388 8-GAL (30.3 L) REFUSE BIN Ship Weight: 9 lb/4.1 kg; Pack: 2; Color: BLA	FG335488 4-GAL (15.5 L) UTILITY BIN Ship Weight: 5.4 lb/2.4 kg; Pack: 2; Color: BLA	FG459200 8" PNEUMATIC CASTER KIT Ship Weight: 25.6 lb/11.6 kg; Pack: 1; Color: 0000	FG459300 SINGLE FULL-EXTENSION DRAWER Ship Weight: 13.5 lb/6.1 kg; Pack: 1; Color: RED
FG342100 Service Cart with 3" Swivel Casters	•	•		
FG342488 Service Cart with 4" Swivel Casters	•	•		
FG345700 Service Cart with Lockable Doors and Sliding Drawer	•	•		
FG409100 Open-Sided Utility Cart	•	•		
FG409300 Utility Cart with Enclosed End Panels on 3 Sides	•	•		
FG409400 Service Cart with Lockable Doors and Sliding Drawer	•	•		
FG409500 Service Cart with Lockable Doors, Enclosed on 3 Sides	•	•		
FG409600 4-Shelf Service Cart	•	•	•	
FG450088 Heavy-Duty Ergo Handle Utility Cart, Small	•	•	•	
FG451388 TradeMaster® Cart with 4-Drawers	•	•	•	
FG452010 Heavy-Duty Ergo Handle Utility Cart with Pneumatic Casters	•	•	•	•
FG452088 Heavy-Duty Ergo Handle Utility Cart, Medium	•	•	•	
FG453388 TradeMaster® Cart with 4-Drawers and Cabinet, Small	•	•	•	
FG454600 Heavy-Duty Ergo Handle Utility Cart	•	•	•	•
FG454610 Heavy-Duty Ergo Handle Utility Cart with Pneumatic Casters	•	•	•	•
FG9T6600 2-Shelf Flat Handle Utility Cart			•	
FG9T6700 2-Shelf Flat Handle Utility Cart			•	
FG9T6800 Executive Series™ Service Cart	•	•		
2128657 Heavy-Duty 4-Shelf Ergo Utility Cart	•	•		



FG424700BLA

Why Structural Foam Stock Tanks?

STRENGTH

Superior strength without the need for a metal frame

DURABILITY

Seamless structures won't leak, rust, chip, dent, or peel, even under the heaviest use.

EFFICIENCY

Lighter weight means easier to operate.
Structural foam construction minimizes maintenance.



Stock Tanks

Super-tough structural foam construction for superior performance and durability in all kinds of weather.

- Four sizes to fit all your watering needs, from 50 to 300 gallons
- Seamless construction for outstanding durability
- Oversize 1½" drain plug for easy draining and cleaning
- All-plastic anti-siphon float valve provides constant water level

STEPPED SIDEWALLS
Resist bowing and provide added stability.

SEAMLESS DESIGN
Prevents leaking and cracking.

REINFORCED RIBBING
Provides added strength and durability.



FG424288



FG424700



FG424300

FLOAT VALVE OPTION

STOCK TANK DRAIN PLUG KIT



FG424806 fits all Rubbermaid® Stock Tanks.



FG505012 fits all Rubbermaid® Stock Tanks.

NO.	COLOR	DESCRIPTION	U.S. DIMENSIONS	U.S. CAPACITY	U.S. SHIP WT/CTN	METRIC DIMENSIONS	METRIC CAPACITY	METRIC SHIP WT/CTN	PACK
FG424300	BLA	50 U.S. Gallon Stock Tank	52.0" l x 31.0" w x 12.0" h	50.0 gal	23.5 lb	132.1 cm x 78.7 cm x 30.5 cm	189.2 L	10.7 kg	1
FG424288	BLA	100 U.S. Gallon Stock Tank	53.0" l x 31.0" w x 25.0" h	100.0 gal	32.4 lb	134.6 cm x 78.7 cm x 63.5 cm	378.5 L	14.7 kg	1
FG424500	BLA	150 U.S. Gallon Stock Tank	58.0" l x 39.0" w x 25.0" h	150.0 gal	53.0 lb	147.3 cm x 99.1 cm x 63.5 cm	567.8 L	24.0 kg	1
FG424700	BLA	300 U.S. Gallon Stock Tank	63.3" l x 69.0" w x 25.0" h	300.0 gal	83.0 lb	160.7 cm x 175.3 cm x 63.5 cm	1135.5 L	37.6 kg	1
FG424806	BLA	Stock Tank Float Valve	9.0" l x 5.0" w x 6.3" h	N/A	12.0 lb	22.9 cm x 12.7 cm x 15.9 cm	N/A	5.4 kg	6
FG505012		Stock Tank Drain Plug Kit	N/A	N/A	2.5 lb	N/A	N/A	1.1 kg	12



FG424288BLA



Big Wheel Carts

Designed for heavy-duty, long-lasting use.

- Smooth, all-plastic, one-piece tub construction is easy to dump and clean
- Large 20" flat-free wheels roll smoothly over rough surfaces
- FG564200 has a weighted load capacity of 300 lbs and holds up to 7.5 cu ft (.2 m³) level capacity or 8.75 cu ft (.25 m³) heaped capacity



FG564200BLA

NO.	COLOR	DESCRIPTION	U.S. DIMENSIONS	U.S. LOAD	U.S. SIZE	U.S. SHIP WT/CTN	METRIC DIMENSIONS	METRIC LOAD	METRIC SIZE	METRIC SHIP WT/CTN	PACK
FG564200	BLA	8.75-Cu.-Ft. Big Wheel Cart	58.0" l x 32.8" w x 28.3" h	300.0 lb	8.75 cu ft	45.2 lb	147.3 cm x 83.2 cm x 71.8 cm	136.0 kg	0.2 m ³	20.5 kg	1
M1564200	N/A	Wheel for FG564200	N/A	N/A	N/A	N/A	N/A	N/A	N/A	N/A	1

BRUTE® Totes

The ultimate storage and transport container.

- Reinforced ribbed bottom protects container during dragging
- User-friendly grip handles decrease potential for back injury and finger strain
- Lid snaps tight, keeping contents secure



FG9S3000 / FG9S3100



2166020

NO.	COLOR	DESCRIPTION	U.S. DIMENSIONS	U.S. CAPACITY	U.S. SHIP WT/CTN	METRIC DIMENSIONS	METRIC CAPACITY	METRIC SHIP WT/CTN	PACK
FG9S3000	WHT, GRAY	BRUTE® Tote with Lid	27.9" l x 16.5" w x 10.7" h	14.0 gal	46.0 lb	70.8 cm x 41.9 cm x 27.2 cm	53.0 L	20.9 kg	6
FG9S3100	WHT, GRAY	BRUTE® Tote with Lid	27.9" l x 17.4" w x 15.1" h	20.0 gal	53.0 lb	70.8 cm x 44.1 cm x 38.4 cm	75.7 L	24.0 kg	6
2166020	DARK GREEN	BRUTE® Tote with Lid	27.9" l x 17.4" w x 15.1" h	20.0 gal	53.0 lb	70.8 cm x 44.1 cm x 38.4 cm	75.7 L	24.0 kg	6

Stack and Nest Palletote® Boxes

For cost-effective storage and transportation.

- Fits 40" and 48" pallets with no overhang
- Nestable for efficient storage and transport, stackable with and without lids
- All plastic construction won't rust, dent, chip, or peel
- Rounded corners and smooth surfaces are easy to clean
- Slip-resistant, extended bottom
- Materials are FDA-compliant for food contact and certified to NSF Std. #2



FG173100



See Platform Trucks section for FG440300 / FG173100

NO.	COLOR	DESCRIPTION	U.S. DIMENSIONS	U.S. CAPACITY	U.S. SHIP WT/CTN	METRIC DIMENSIONS	METRIC CAPACITY	METRIC SHIP WT/CTN	PACK
FG172100	GRAY	Palletote® Box	19.5" l x 15.5" w x 10.0" h	1.3 cu ft	42.6 lb	49.5 cm x 39.4 cm x 25.4 cm	0.04 m ³	19.3 kg	10
FG172200	GRAY	Palletote® Box	19.5" l x 15.5" w x 13.0" h	1.6 cu ft	57.9 lb	49.5 cm x 39.4 cm x 33.0 cm	0.05 m ³	26.3 kg	10
FG173100	GRAY	Palletote® Box	23.5" l x 19.5" w x 10.0" h	2.0 cu ft	60.6 lb	59.7 cm x 49.5 cm x 25.4 cm	0.06 m ³	27.5 kg	10

Lids

NO.	COLOR	DESCRIPTION	U.S. DIMENSIONS	U.S. CAPACITY	U.S. SHIP WT/CTN	METRIC DIMENSIONS	METRIC CAPACITY	METRIC SHIP WT/CTN	PACK
FG172000	GRAY	Palletote® Lid for FG172100, FG172200	19.6" l x 15.6" w x 1.0" h	N/A	16.1 lb	49.9 cm x 39.7 cm x 2.5 cm	N/A	7.3 kg	10
FG173000	GRAY	Palletote® Lid for FG173100	23.8" l x 19.8" w x 1.0" h	N/A	22.1 lb	60.3 cm x 50.2 cm x 2.5 cm	N/A	10.0 kg	10

UTILITY REFUSE AND RECYCLING

DECORATIVE REFUSE

CLEANING

MATERIAL HANDLING

WASHROOM

FOODSERVICE

ACCESSORIES & INDEX





WASHROOM



1980826



1938171

SKIN CARE

Ingredients186
 Education187

Counter Mount Touch-Free

OneShot® Foam188
 OneShot® Lotion189

Wall Mount Touch-Free

AutoFoam with LumeCel™190
 AutoFoam190

Wall Mount Manual

FLex™192
 Manual Foam193

SANITIZER STANDS

AutoFoam Premium Floor Stand195
 AutoFoam Standard Floor Stand195

AIR CARE

Active (Aerosol)

Microburst® 3000 with LumeCel™198
 Microburst® 3000199
 Microburst® 9000200

Passive (Non-Aerosol)

TCell™202

FIXTURES

AutoFaucet®204
 AutoFlush® Sidemount206
 AutoFlush® Clamp207

SURFACE CARE

AutoClean®208
 Clean Seat209

ACCESSORIES

Baby Changing Stations210
 Sanitary Bins211
 Safti-Grip® Bath Mats211

WASHROOM

UTILITY REFUSE
AND RECYCLING

DECORATIVE REFUSE

CLEANING

MATERIAL HANDLING

WASHROOM

FOODSERVICE

ACCESSORIES
& INDEX

SKIN CARE

Protect your facility's image and employees' well-being with RCP's full line of skin care solutions. Our reliable dispensing systems and high-quality soaps and sanitizers help to positively impact your bottom line.



LEARN THE INGREDIENTS

Soaps and sanitizers are made up of a combination of ingredients to meet your specific needs.

SOAP: Water + Surfactant + Fragrance / Dye / Moisturizer / Antibacterial

1
2
3
4
5

SANITIZER: Water + Moisturizer + Antibacterial / Alcohol

4
5
6

1 SURFACTANT:
Cleansing and foaming agent that removes dirt and germs

2 FRAGRANCE:
Clean with or without added scents

3 DYE:
Clean with or without added color

4 MOISTURIZER:
Helps to keep skin hydrated

5 ANTIBACTERIAL:
Alcohol-free ingredient helps to kill germs on hands

6 ALCOHOL:
Active ingredient used in alcohol-based sanitizers

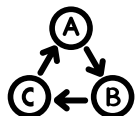

KNOW THE DIFFERENCES

SOAP



FOAM

- Dispenses in a light, airy consistency
- Lathers quickly for an easy hand wash
- Rinses easier to reduce drain maintenance



LOTION

- Dispenses in a thick, liquid consistency
- Creates a rich lather
- Most effective in eliminating hand bacteria¹
- Uses more water in day-to-day handwashing activities

SANITIZER



FOAM

- Dispenses in a light, airy consistency
- Use frequently between hand washes
- Compliments a proper hand wash
- Kills 99.99% of tested bacteria*

*For a list of tested bacteria and additional information visit: www.rubbermaidcommercial.com/tested-bacteria

¹Foam Soap is Not as Effective as Liquid Soap in Eliminating Hand Microbial Flora
Nicolette Dixon - [https://www.ajicjournal.org/article/S0196-6553\(17\)30082-2/fulltext](https://www.ajicjournal.org/article/S0196-6553(17)30082-2/fulltext)

DISPENSER EDUCATION



COUNTER MOUNT AUTOMATIC

- Dispenses soap touch-free
- Controlled portioning reduces refill maintenance and waste
- Requires batteries for operation
- Includes helpful indicator lights
- Optimizes wall space

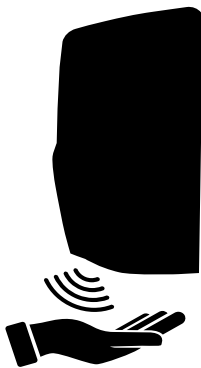

WALL MOUNT AUTOMATIC

- Dispenses soap touch-free
- Controlled portioning reduces refill maintenance and waste
- Requires batteries for operation
- Includes helpful indicator lights
- Convenient, easy installation
- AutoFoam dispenser with LumeCel™ technology is powered by indoor light

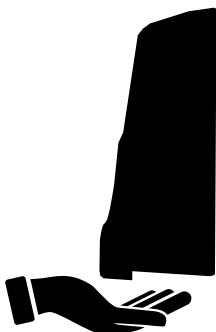

WALL MOUNT MANUAL

- Dispenses soap on demand with push bar
- Includes viewing window for refill maintenance
- Operates without batteries
- Convenient, easy installation
- Most economical option

*Excludes AutoFoam dispenser with LumeCel™ technology, which is powered by indoor light.



1938171

OneShot® Foam

Smart Sensor™ Technology dispenses soap automatically to help improve the health and enhance the image of your facility.

- Touch-free delivery helps prevent cross-contamination to help reduce the spread of germs
- Reliable, controlled dispensing of concentrated soaps eliminates over-use and costly waste
- Refill and battery-life indicator lights
- Industry-leading battery life (up to 2 years or 90,000 cycles for OneShot® foam dispensers)
- No clogs, drips, or messy cleanup
- Closed dispensing system provides world-class reliability
- Programmable options for 800mL and 1600mL refills
- 0.8mL target dosage
- Pairs well with the RCP AutoFaucet® design
- Mounts flush with the counter to maintain the clean look of your washroom and optimizes wall space



ADA COMPLIANT

OneShot® Foam Dispensers & Accessories

NO.	DESCRIPTION	U.S. SHIP WT/CASE	U.S. CASE CUBE	METRIC SHIP WT/CASE	METRIC CASE CUBE	CASE PACK
1938171	OneShot® Foam Dispenser Low Profile — Polished Chrome	10.0 lb	1.2 ft³	4.5 kg	0.03 m³	4
FG4870465	OneShot® Foam Dispenser Low Profile Metal — Polished Chrome	12.0 lb	1.5 ft³	5.4 kg	0.04 m³	4
490071	OneShot® A/C Adapter	1.2 lb	0.2 ft³	0.5 kg	0.01 m³	1
490099	OneShot® 6V Adapter (bayonet)	0.3 lb	1.0 ft³	0.1 kg	0.03 m³	1
490100	OneShot® Adapter Wire (bayonet)	0.1 lb	1.5 ft³	0.1 kg	0.04 m³	1

OneShot® Foam Refills (for use with OneShot® Foam Dispensers)

- More hand washes per refill reduce labor and soap costs (up to 2,000 hand washes per refill)
- High quality formulations enriched with moisturizers
- Sealed refill helps eliminate potential for contamination



● NSF and ● Green Seal apply to specific refills only; see below.



FG750386

FG750389

NO.	DESCRIPTION	SIZE	U.S. SHIP WT/CASE	U.S. CASE CUBE	METRIC SHIP WT/CASE	METRIC CASE CUBE	CASE PACK
● FG750517	Moisturizing Foam Hand Soap	800 mL	9.5 lb	0.4 ft³	4.3 kg	0.1 m³	4
● FG750386	Moisturizing Foam Hand Soap	1600 mL	18.5 lb	0.6 ft³	8.4 kg	0.02 m³	4
●● FG750389	Dye & Fragrance Free Foam Hand Soap — E1†	800 mL	9.5 lb	0.4 ft³	4.3 kg	0.1 m³	4
●● FG750390	Dye & Fragrance Free Foam Hand Soap — E1†	1600 mL	18.5 lb	0.6 ft³	8.4 kg	0.02 m³	4

OneShot® Lotion

Smart Sensor™ Technology dispenses soap automatically to help improve the health and enhance the image of your facility.

- Touch-free delivery helps prevent cross-contamination to help reduce the spread of germs
- Reliable, controlled dispensing of concentrated soaps eliminates over-use and costly waste
- Refill and battery-life indicator lights
- Industry-leading battery life (up to 3 years or 120,000 cycles for OneShot® lotion dispensers)
- No clogs, drips, or messy cleanup
- Closed dispensing system provides world-class reliability
- Programmable options for 800mL and 1600mL refills
- 0.8mL target dosage
- Pairs well with the RCP AutoFaucet® design
- Mounts flush with the counter to maintain the clean look of your washroom and optimizes wall space



ADA COMPLIANT



FG401310



FG402241



FG402243

OneShot® Lotion Dispensers & Accessories

NO.	DESCRIPTION	U.S. SHIP WT/CASE	U.S. CASE CUBE	METRIC SHIP WT/CASE	METRIC CASE CUBE	CASE PACK
FG401310	OneShot® Liquid Dispenser — Polished Chrome/Black	8.0 lb	1.2 ft³	3.6 kg	0.03 m³	4
FG402241	OneShot® Liquid Dispenser Low Profile — Polished Chrome	12.0 lb	1.2 ft³	5.4 kg	0.03 m³	4
FG402243	OneShot® Liquid Dispenser Low Profile Metal — Polished Chrome	12.0 lb	1.2 ft³	5.4 kg	0.03 m³	4
490071	OneShot® A/C Adapter	1.2 lb	0.2 ft³	0.5 kg	0.01 m³	1
490099	OneShot® 6V Adapter (bayonet)	0.3 lb	1.0 ft³	0.1 kg	0.03 m³	1
490100	OneShot® Adapter Wire (bayonet)	0.1 lb	1.5 ft³	0.1 kg	0.04 m³	1

OneShot® Lotion Refills (for use with OneShot® Lotion Dispensers)

- More hand washes per refill reduce labor and soap costs (up to 2,000 hand washes per refill)
- High quality formulations enriched with moisturizers
- Sealed refill helps eliminate potential for contamination



● Green Seal apply to specific refills only; see below.



FG4013131 / FG4015431



FG402363 / FG402364



FG4013111 / FG4015411



2018581 / 2018582

NO.	DESCRIPTION	SIZE	U.S. SHIP WT/CASE	U.S. CASE CUBE	METRIC SHIP WT/CASE	METRIC CASE CUBE	CASE PACK
● FG4013131	Green Seal Certified Lotion Hand Soap	800 mL	9.0 lb	0.3 ft³	4.1 kg	0.01 m³	4
● FG4015431	Green Seal Certified Lotion Hand Soap	1600 mL	18.0 lb	0.5 ft³	8.2 kg	0.01 m³	4
● FG402363	Dye & Fragrance Free Lotion Hand Soap	800 mL	9.0 lb	0.3 ft³	4.1 kg	0.01 m³	4
● FG402364	Dye & Fragrance Free Lotion Hand Soap	1600 mL	18.0 lb	0.5 ft³	8.2 kg	0.01 m³	4
● FG4013111	Moisturizing Lotion Hand Soap	800 mL	9.0 lb	0.3 ft³	4.1 kg	0.01 m³	4
● FG4015411	Moisturizing Lotion Hand Soap	1600 mL	18.0 lb	0.5 ft³	8.2 kg	0.01 m³	4
2018582	Antibacterial Lotion Hand Soap	800 mL	8.5 lb	0.3 ft³	3.9 kg	0.01 m³	4
2018581	Antibacterial Lotion Hand Soap	1600 mL	16.3 lb	0.6 ft³	7.4 kg	0.02 m³	4

*This product meets Green Seal™ Standard GS-41A based on effective performance and protective limits on VOCs and human & environmental toxicity. GreenSeal.org.



AutoFoam with LumeCel™

LumeCel™-powered soap dispensers use light to operate automatically.

- Touch-free delivery dispenses soap automatically to help prevent cross-contamination
- LumeCel™ technology efficiently powers dispensers using only indoor light and is battery free
- Refill & light alerts indicate when refill is required or energy cells need more light
- Choose from a variety of color options to complement your washroom
- Contributes to earning LEED credits
- High capacity refill delivers up to 2,750 hand washes



● NSF and ● Green Seal apply to specific refills only; see below.



1980826



1980829



1980828

AutoFoam with LumeCel™ Dispensers

NO.	DESCRIPTION	U.S. DIMENSIONS	U.S. SHIP WT/ CASE	METRIC DIMENSIONS	METRIC SHIP WT/CASE	CASE PACK
1980826	AutoFoam Dispenser with LumeCel™ Technology – Black/Chrome	5.5" l x 5.5" w x 11.2" h	33.6 lb	14.0 cm x 14.0 cm x 28.5 cm	15.2 kg	10
1980828	AutoFoam Dispenser with LumeCel™ Technology – White/Grey Pearl	5.5" l x 5.5" w x 11.2" h	33.6 lb	14.0 cm x 14.0 cm x 28.5 cm	15.2 kg	10
1980829	AutoFoam Dispenser with LumeCel™ Technology – Black/Black Pearl	5.5" l x 5.5" w x 11.2" h	33.6 lb	14.0 cm x 14.0 cm x 28.5 cm	15.2 kg	10

AutoFoam

Highest quality foam soap in an attractive touch-free dispenser delivers superior cost savings.

- Touch-free delivery dispenses soap automatically to help prevent cross-contamination
- Long battery life lasts up to three years or 120,000 handwashing cycles
- Refill & battery alerts indicate when refill or batteries need to be replaced
- Choose from a variety of color options to complement your washroom
- High capacity refill delivers up to 2,750 hand washes



FG750127



FG750411

AutoFoam Dispensers & Accessories

NO.	DESCRIPTION	U.S. DIMENSIONS	U.S. SHIP WT/CASE	U.S. CASE CUBE	METRIC DIMENSIONS	METRIC SHIP WT/CASE	METRIC CASE CUBE	CASE PACK
FG750127	AutoFoam Dispenser — Black/Black Pearl	5.3" l x 5.2" w x 10.9" h	24.8 lb	25.3 ft³	13.3 cm x 13.2 cm x 27.6 cm	11.2 kg	0.7 m³	10
FG750411	AutoFoam Dispenser — Black/Chrome	5.3" l x 5.2" w x 10.9" h	24.8 lb	25.3 ft³	13.3 cm x 13.2 cm x 27.6 cm	11.2 kg	0.7 m³	10
1892265	AutoFoam Drip Tray	4.3" l x 3.9" w x 5.7" h	10.1 lb	0.4 ft³	10.9 cm x 9.9 cm x 14.5 cm	4.6 kg	0.01 m³	6
400845	AutoFoam Dispenser Key	1.5" l x 0.8" w x 0.04" h	0.7 lb	0.008 ft³	4.0 cm x 1.9 cm x 0.1 cm	0.3 kg	0.0003 m³	50



2143543 /
FG750411

AutoFoam Refills
(for use with AutoFoam and AutoFoam with LumeCel™ Dispensers)

- More hand washes per refill reduce labor and soap costs
- High capacity refill delivers up to 2,750 hand washes
- Hygienically sealed refills reduce potential contamination
- Boxless refills evacuate fully to reduce waste



• NSF and • Green Seal apply to specific refills only; see below.



FG750112



2018595



2080802

AutoFoam Hand Soap Refills

NO.	DESCRIPTION	SIZE	U.S. SHIP WT/CASE	U.S. CASE CUBE	METRIC SHIP WT/CASE	METRIC CASE CUBE	CASE PACK
• FG750112	Moisturizing Foam Hand Soap	1100 mL	10.9 lb	0.3 ft ³	4.9 kg	0.01 m ³	4
• 2018595	Antibacterial Foam Hand Soap — E2	1100 mL	10.4 lb	0.3 ft ³	4.7 kg	0.01 m ³	4
2175515	Dye and Fragrance Free Hand Soap	1100 mL	10.4 lb	0.3 ft ³	4.7 kg	0.09 m ³	4

*This product meets Green Seal™ Standard GS-41A based on effective performance and protective limits on VOCs and human & environmental toxicity. GreenSeal.org.

AutoFoam Hand Sanitizer Refills

NO.	DESCRIPTION	SIZE	U.S. SHIP WT/CASE	U.S. CASE CUBE	METRIC SHIP WT/CASE	METRIC CASE CUBE	CASE PACK
• 2080802	Alcohol Foam Hand Sanitizer — E3	1000 mL	10.8 lb	0.3 ft ³	4.9 kg	0.01 m ³	4
• 2147031	Alcohol-Free Foam Hand Sanitizer — E3	1100 mL	10.7 lb	0.3 ft ³	4.9 kg	0.01 m ³	4



FLex™

FLex's™ revolutionary design allows you to use either foam or lotion refills in the same dispenser.

- Choose from 0.4 mL, 0.65 mL, or 1.0 mL doses, using an adjustable, internal lever
- Specially-treated coating on pushbar helps reduce growth of bacteria and germs
- High-capacity refills deliver up to 3,250 hand washes per 1,300 mL refill
- Available in small or large dispenser sizes to meet the needs of your facility



ADA COMPLIANT



3486589



3486592



The only system with adjustable portion control ON the dispenser — choose from 3 dose sizes: 0.4 mL – 0.65 mL – 1.0 mL.

FLex™ Dispensers

NO.	DESCRIPTION	U.S. DIMENSIONS	U.S. SHIP WT/CASE	U.S. CASE CUBE	METRIC DIMENSIONS	METRIC SHIP WT/CASE	METRIC CASE CUBE	CASE PACK
3486589	FLex™ Dispenser White — 500 mL	3.9" d x 5.0" w x 8.7" h	9.5 lb	1.4 ft³	10.0 cm x 12.7 cm x 22.0 cm	4.3 kg	0.04 m³	10
3486590	FLex™ Dispenser Black — 500 mL	3.9" d x 5.0" w x 8.7" h	9.5 lb	1.4 ft³	10.0 cm x 12.7 cm x 22.0 cm	4.3 kg	0.04 m³	10
3486591	FLex™ Dispenser White — 1000 mL, 1300 mL	3.9" d x 5.8" w x 11.7" h	13.7 lb	1.9 ft³	10.0 cm x 14.6 cm x 29.8 cm	6.2 kg	0.04 m³	10
3486592	FLex™ Dispenser Black — 1000 mL, 1300 mL	3.9" d x 5.8" w x 11.7" h	13.7 lb	1.9 ft³	10.0 cm x 14.6 cm x 29.8 cm	6.2 kg	0.04 m³	10

FLex™ Refills

(for use with FLex™ Dispensers)



● NSF and ● Green Seal apply to specific refills only; see below.



3486561



3486571



3486577



3486562



3486572

FLex™ Foam Hand Soap & Hair and Body Foam Soap Refills

NO.	DESCRIPTION	SIZE	U.S. SHIP WT/CASE	U.S. CASE CUBE	METRIC SHIP WT/CASE	METRIC CASE CUBE	CASE PACK
● 3486561	Moisturizing Foam Hand Soap	500 mL	6.6 lb	0.4 ft³	3.0 kg	0.01 m³	5
● 3486571	Moisturizing Foam Hand Soap	1300 mL	9.8 lb	0.5 ft³	4.4 kg	0.01 m³	3
● 3486575	Hair & Body Foam Soap	1300 mL	9.7 lb	0.5 ft³	4.4 kg	0.01 m³	3

FLex™ Foam Hand Sanitizer Refills

NO.	DESCRIPTION	SIZE	U.S. SHIP WT/CASE	U.S. CASE CUBE	METRIC SHIP WT/CASE	METRIC CASE CUBE	CASE PACK
● 3486577	Alcohol Foam Hand Sanitizer — E3	1000 mL	8.6 lb	0.5 ft³	3.9 kg	0.01 m³	3

FLex™ Lotion Refills

NO.	DESCRIPTION	SIZE	U.S. SHIP WT/CASE	U.S. CASE CUBE	METRIC SHIP WT/CASE	METRIC CASE CUBE	CASE PACK
3486562	Moisturizing Lotion Hand Soap	500 mL	6.8 lb	0.4 ft³	3.1 kg	0.01 m³	5
3486572	Moisturizing Lotion Hand Soap	1300 mL	9.8 lb	0.5 ft³	4.5 kg	0.01 m³	3

*This product meets Green Seal™ Standard GS-41A based on effective performance and protective limits on VOCs and human & environmental toxicity. GreenSeal.org.

Manual Foam

The perfect balance between quality and value. An economical dispensing system option that delivers foam soap on demand.

- Specially-treated coating on pushbar helps reduce growth of bacteria and germs
- Viewing window enables maintenance staff to monitor when to replace refills
- High-capacity refills deliver up to 2,000 hand washes per 800 mL refill



FG450017



FG450034



Manual Foam Dispensers

NO.	DESCRIPTION	U.S. DIMENSIONS	U.S. SHIP WT/CASE	U.S. CASE CUBE	METRIC DIMENSIONS	METRIC SHIP WT/CASE	METRIC CASE CUBE	CASE PACK
FG450017	Manual Foam Dispenser — White	5.3" l x 4.8" w x 9.8" h	1.3 lb	2.0 ft ³	13.3 cm x 12.1 cm x 24.8 cm	0.6 kg	0.1 m ³	10
FG450034	Manual Foam Dispenser — Black	5.3" l x 4.8" w x 9.8" h	1.0 lb	2.2 ft ³	13.3 cm x 12.1 cm x 24.8 cm	0.5 kg	0.1 m ³	10



FG450019



2080803

Manual Foam Hand Soap Refills

NO.	DESCRIPTION	SIZE	U.S. SHIP WT/CASE	U.S. CASE CUBE	METRIC SHIP WT/CASE	METRIC CASE CUBE	CASE PACK
FG450019	Moisturizing Foam Hand Soap	800 mL	12.8 lb	0.3 ft ³	5.8 kg	0.01 m ³	6

Manual Foam Hand Sanitizer Refills

NO.	DESCRIPTION	SIZE	U.S. SHIP WT/CASE	U.S. CASE CUBE	METRIC SHIP WT/CASE	METRIC CASE CUBE	CASE PACK
2080803	Alcohol Foam Hand Sanitizer	1000 mL	10.8 lb	0.4 ft ³	4.9 kg	0.01 m ³	4



When ordering products with **BOLD** color codes, please specify color code after the product number. Refer to the Standard Color Guide at the back of the catalog.

Premium

Standard



FG750824 /
FG750411

FG750824 /
1980826



2143543 /
FG750411

2143543 /
1980826

AutoFoam Premium Floor Stand

Offers superior compatibility, allowing touch-free dispensers to be mounted to a sturdy, secure stand for demanding commercial environments.

- All-metal base and pole helps stabilize the hand sanitizer stand for secure placement
- Works with RCP AutoFoam and AutoFoam with LumeCel™ dispensers and sanitizer refills
- Built-in drip tray helps eliminate messes on floors by collecting excess sanitizer
- Optimal height allows for quick, convenient access for users on-the-go
- Space for customized messaging; hand hygiene label included to clearly promote health and wellness

NO.	DESCRIPTION	COLOR	U.S. DIMENSIONS	U.S. SHIP WT/ CASE	METRIC DIMENSIONS	METRIC SHIP WT/CASE	CASE PACK
FG750824	AutoFoam Premium Floor Stand	Black	51.6" l x 16.2" w x 5.7" h	40.1 lb	131.0 cm x 41.1 cm x 14.5 cm	18.2 kg	1

AutoFoam Standard Floor Stand

Allows touch-free dispensers to be mounted to a lightweight, easily movable stand to meet the changing needs of commercial facilities.

- Two-piece pole design is easy to assemble and can be broken down for convenient storage, as needed
- Free-standing floor stand is easily movable to adapt to changing needs within your facility
- Works with RCP AutoFoam and AutoFoam with LumeCel™ dispensers and sanitizer refills

NO.	DESCRIPTION	COLOR	U.S. DIMENSIONS	U.S. SHIP WT/ CASE	METRIC DIMENSIONS	METRIC SHIP WT/CASE	CASE PACK
2143543	AutoFoam Standard Floor Stand	Black	51.0" l x 12.0" w x 12.0" h	16.0 lb	539.8 mm x 319.1 mm x 152.4 mm	7.3 kg	1

AIR CARE

Protect the perception and reputation of your facility with RCP's full line of air care solutions. Our consistent dispensing systems blend into the washroom environment, attack odors at the source, and release fresh-smelling fragrances to create the ultimate sense of cleanliness.

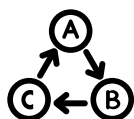

KNOW THE FRAGRANCE FAMILIES

RCP's fragrance options fall within five distinct fragrance families, based upon their scents:



FLORAL

Characterized by:

Radiant scents, such as rose, jasmine, and violet; green scents, which are reminiscent of freshly cut grass, leaves, and stems.

Available fragrances:

Cucumber Melon
Country Delight™



FRUITY

Characterized by:

Luscious fruity scents, such as apple, pear, plum, mango, peach, and melon.

Available fragrances:

Mango
Mountain Peaks
Orchard Fields



CITRUS

Characterized by:

Invigorating and uplifting scents, such as lemon, mandarin, and other citrus oils.

Available fragrances:

Mandarin Orange
Citrus



HERBAL

Characterized by:

Powerful, aromatic herbal scents, such as rosemary, mint, coriander, lavender, and sage.

Available fragrance:

Ocean Breeze



FOUGÈRE

Characterized by:

Masculine scents, such as lavender, moss, and woods.

Available fragrance:

Linen Fresh
Blue Splash

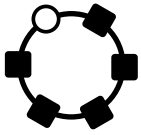

WHAT SETS RCP FRAGRANCES APART

Traditional air fresheners only camouflage malodors; all of RCP's fragrance options have odor neutralizer, which attacks and effectively eliminates unavoidable odors in the washroom. Thus, completing two jobs in one – removing odors and creating fresh-smelling environments.

ODOR NEUTRALIZER

Locks onto malodor molecules to neutralize the odor.

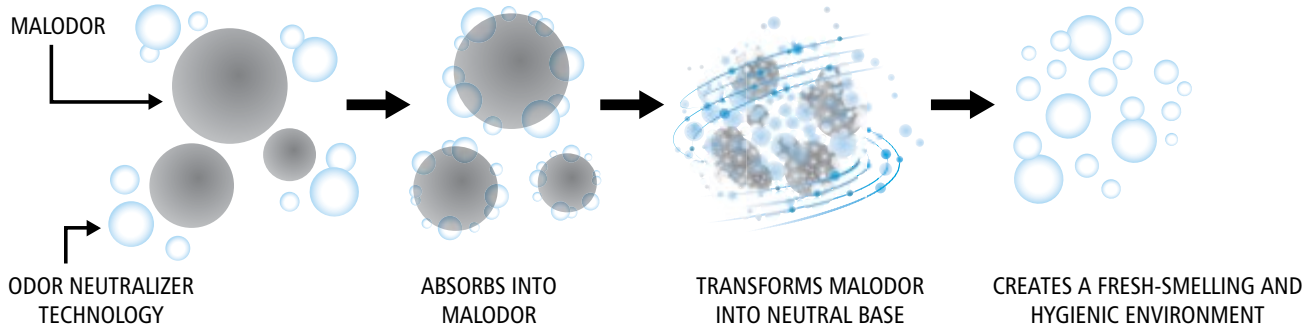

FRAGRANCE-FREE ODOR NEUTRALIZER

RCP also offers a Pure odor neutralizer for environments, where odor removal is desired, but fragrance is not. This option is a blend of natural extracts and purified water that attracts, captures, and neutralizes malodors.

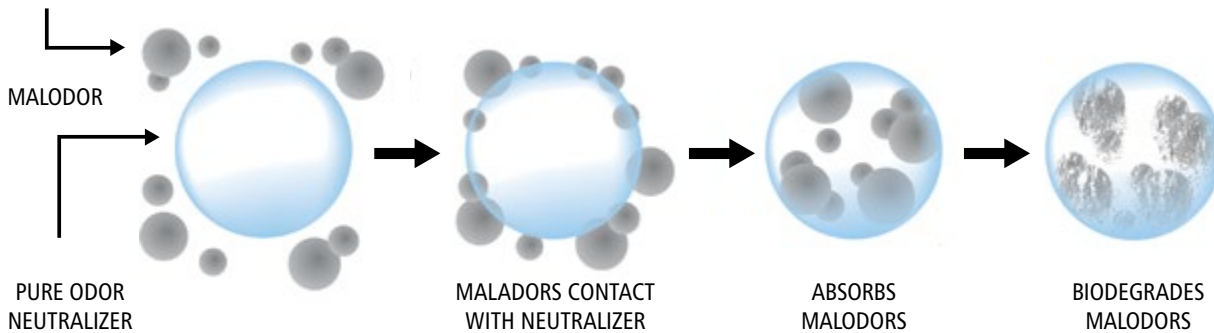

DISPENSER EDUCATION

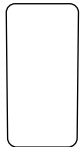

ACTIVE

- Aerosol system relies on valve-actuating mechanism to dispense fragrance automatically
- Programmable dispensing options reduce refill maintenance and waste
- Requires batteries for operation*
- Includes helpful battery and refill life indicators
- Microburst 3000 with LumeCel™ technology is battery free operation



PASSIVE

- Relies on natural air movement to dispense fragrance
- Operates without batteries
- Non-aerosol system does not include propellants or added harmful volatile organic compounds (VOCs)

*Excludes Microburst® 3000 dispenser with LumeCel™ technology, which is powered by indoor light.

Microburst® 3000 with LumeCel™**Battery-free dispensers provide a fresh-smelling environment for patrons.**

- LumeCel™ technology efficiently powers dispenser using stored energy from indoor light
- Features a refill actuator, a patented, valve-actuating mechanism that releases fine fragrance mist into the air
- Maximize product life and cost-efficiency with a combination of adjustable program settings:
 - Spray interval: 7, 14, or 28 minutes
 - Hours per day: 12 or 24
 - Days per week: 5, 6, or 7
- LCD indicator alerts the facility staff when refills need to be replaced



2095206



2095207



2095208

Microburst® 3000 with LumeCel™ Dispensers

NO.	DESCRIPTION	U.S. DIMENSIONS	U.S. SHIP WT/CASE	U.S. CASE CUBE	METRIC DIMENSIONS	METRIC SHIP WT/CASE	CASE PACK
2095206	Microburst® 3000 Dispenser with LumeCel™ Technology — Black	4.8" w x 8.0" h x 5.0" l	7.8 lb		12.1 cm x 20.3 cm x 12.7 cm	3.5 kg	6
2095207	Microburst® 3000 Dispenser with LumeCel™ Technology — White	4.8" w x 8.0" h x 5.0" l	7.8 lb		12.1 cm x 20.3 cm x 12.7 cm	3.5 kg	6
2095208	Microburst® 3000 Dispenser with LumeCel™ Technology — Chrome	4.8" w x 8.0" h x 5.0" l	7.8 lb		12.1 cm x 20.3 cm x 12.7 cm	3.5 kg	6

**COST-IN-USE:**

Light-powered LumeCel™ technology reduces the expense of purchasing, storing, replacing, and disposing of batteries

**PRODUCTIVITY:**

Requires less maintenance and eliminates the task of replacing batteries

Microburst® 3000 with LumeCel™ Refills

Lasts up to 90 days, or 3 months, based on program settings.



FG4012551



FG4012561



FG4012571



FG4012581



FG4012591

NO.	DESCRIPTION	FRAGRANCE FAMILY	U.S. SHIP WT/CASE	U.S. CASE CUBE	METRIC SHIP WT/CASE	METRIC CASE CUBE	CASE PACK
FG4012551	Microburst® 3000 Refill — Linen Fresh™	Fougère	3.0 lb	0.1 ft³	1.4 kg	0.04 m³	12
FG4012561	Microburst® 3000 Refill — Orchard Fields	Fruity	3.0 lb	0.1 ft³	1.4 kg	0.04 m³	12
FG4012571	Microburst® 3000 Refill — Mountain Peaks	Fruity	3.0 lb	0.1 ft³	1.4 kg	0.04 m³	12
FG4012581	Microburst® 3000 Refill — Ocean Breeze	Herbal	3.0 lb	0.1 ft³	1.4 kg	0.04 m³	12
FG4012591	Microburst® 3000 Refill — Country Delight™	Floral	3.0 lb	0.1 ft³	1.4 kg	0.04 m³	12
FG401690	Microburst® 3000 Refill — Mango	Fruity	3.0 lb	0.1 ft³	1.4 kg	0.04 m³	12
FG402408	Microburst® 3000 Refill — Mandarin Orange	Citrus	3.0 lb	0.1 ft³	1.4 kg	0.04 m³	12
FG750363	Microburst® 3000 Refill — Cucumber Melon	Fruity	3.0 lb	0.1 ft³	1.4 kg	0.04 m³	12

Microburst® 3000

Keep your washroom smelling fresh with a space-saving, adjustable dispenser design.

- Compact design blends into your existing washroom at half the size of RCP's Standard dispenser
- Features a refill actuator, a patented, valve-actuating mechanism that releases fine fragrance mist into the air
- Maximize product life and cost-efficiency with a combination of adjustable program settings:
 - Spray interval: 7, 14, or 28 minutes
 - Hours per day: 12 or 24
 - Days per week: 5, 6, or 7
- LCD indicator displays battery life and days remaining to refill, with an optional low battery/refill audio tone



Microburst® 3000 Dispensers*

NO.	DESCRIPTION	U.S. DIMENSIONS	U.S. SHIP WT/CASE	U.S. CASE CUBE	METRIC DIMENSIONS	METRIC SHIP WT/CASE	METRIC CASE CUBE	CASE PACK
1793531	Microburst® 3000 LCD Dispenser — Black	3.3" w x 6.6" h	6.0 lb	0.3 ft³	8.3 cm x 16.8 cm	2.7 kg	0.1 m³	6
1793532	Microburst® 3000 LCD Dispenser — White	3.3" w x 6.6" h	6.0 lb	0.3 ft³	8.3 cm x 16.8 cm	2.7 kg	0.1 m³	6
1793533	Microburst® 3000 LCD Dispenser — Chrome	3.3" w x 6.6" h	6.0 lb	0.3 ft³	8.3 cm x 16.8 cm	2.7 kg	0.1 m³	6

*Requires 2 "C" alkaline batteries (not included)



IMAGE: Maintain a fresh-smelling environment that leaves patrons with a positive impression of your facility



COST-IN-USE: Maximize and control product use with programmable options

Microburst® 3000 Refills

Lasts up to 90 days, or 3 months, based on program settings.



FG4012551 FG4012561 FG4012571 FG4012581 FG4012591

NO.	DESCRIPTION	FRAGRANCE FAMILY	U.S. SHIP WT/CASE	U.S. CASE CUBE	METRIC SHIP WT/CASE	METRIC CASE CUBE	CASE PACK
FG4012551	Microburst® 3000 Refill — Linen Fresh™	Fougère	3.0 lb	0.1 ft³	1.4 kg	0.04 m³	12
FG4012561	Microburst® 3000 Refill — Orchard Fields	Fruity	3.0 lb	0.1 ft³	1.4 kg	0.04 m³	12
FG4012571	Microburst® 3000 Refill — Mountain Peaks	Fruity	3.0 lb	0.1 ft³	1.4 kg	0.04 m³	12
FG4012581	Microburst® 3000 Refill — Ocean Breeze	Herbal	3.0 lb	0.1 ft³	1.4 kg	0.04 m³	12
FG4012591	Microburst® 3000 Refill — Country Delight™	Floral	3.0 lb	0.1 ft³	1.4 kg	0.04 m³	12
FG401690	Microburst® 3000 Refill — Mango	Fruity	3.0 lb	0.1 ft³	1.4 kg	0.04 m³	12
FG402408	Microburst® 3000 Refill — Mandarin Orange	Citrus	3.0 lb	0.1 ft³	1.4 kg	0.04 m³	12
FG750363	Microburst® 3000 Refill — Cucumber Melon	Fruity	3.0 lb	0.1 ft³	1.4 kg	0.04 m³	12

Microburst® 9000

Provides three times the refill capacity of the Microburst 3000, resulting in the highest fragrance output and best cost-in-use.

- LCD indicator displays battery life and days remaining to refill, with an optional low battery/refill audio tone
- Maximize product life and cost-efficiency with a combination of adjustable program settings:
 - Spray interval: 7 or 14 minutes
 - Hours per day: 12 or 24
 - Days per week: 5, 6, or 7
- Features a refill actuator, a patented, valve-actuating mechanism that releases fine fragrance mist into the air



1793535



1793536

Microburst® 9000 Dispensers*

NO.	DESCRIPTION	U.S. DIMENSIONS	U.S. SHIP WT/CASE	U.S. CASE CUBE	METRIC DIMENSIONS	METRIC SHIP WT/CASE	METRIC CASE CUBE	CASE PACK
1793535	Microburst® 9000 LCD Dispenser — White	3.6" w x 8.8" h	7.0 lb	0.5 ft ³	9.0 cm x 22.2 cm	3.2 kg	0.1 m ³	6
1793536	Microburst® 9000 LCD Dispenser — Chrome	3.6" w x 8.8" h	7.0 lb	0.5 ft ³	9.0 cm x 22.2 cm	3.2 kg	0.1 m ³	6

*Requires 2 "D" alkaline batteries (not included).



IMAGE:
Maintain a fresh-smelling environment that leaves patrons with a positive impression of your facility



COST-IN-USE:
Provides the equivalent of three RCP Standard refills, for longer-lasting odor control

Microburst® 9000 Refills

Last up to 180 days based on program settings



FG4012451



FG4012461



FG4012471



FG4012441

NO.	DESCRIPTION	FRAGRANCE FAMILY	U.S. SHIP WT/CASE	U.S. CASE CUBE	METRIC SHIP WT/CASE	METRIC CASE CUBE	CASE PACK
FG4012441	Microburst® 9000 Refill — Linen Fresh™	Fougère	3.0 lb	0.2 ft ³	1.4 kg	0.1 m ³	4
FG4012451	Microburst® 9000 Refill — Orchard Fields	Fruity	3.0 lb	0.2 ft ³	1.4 kg	0.1 m ³	4
FG4012461	Microburst® 9000 Refill — Mountain Peaks	Fruity	3.0 lb	0.2 ft ³	1.4 kg	0.1 m ³	4
FG4012471	Microburst® 9000 Refill — Ocean Breeze	Herbal	3.0 lb	0.2 ft ³	1.4 kg	0.1 m ³	4
FG401693	Microburst® 9000 Refill — Mango	Fruity	3.0 lb	0.2 ft ³	1.4 kg	0.1 m ³	4
FG402093	Microburst® 9000 Refill — Mandarin Orange	Citrus	3.0 lb	0.2 ft ³	1.4 kg	0.1 m ³	4

When ordering products with **BOLD** color codes, please specify color code after the product number. Refer to the Standard Color Guide at the back of the catalog.



UTILITY REFUSE
AND RECYCLING

DECORATIVE REFUSE

CLEANING

MATERIAL HANDLING

WASHROOM

FOODSERVICE

ACCESSORIES
& INDEX

TCell™

Delivers continuous, passive odor control for up to three months. Passive fuel cell technology delivers precise, timed fragrance for up to 90 days of consistent odor control using natural air flow.

- Flexible control settings include: Standard Setting: 60 days - Standard Size Washroom: 3 to 4 stalls/fixtures Light Setting: 90 days - Smaller Size Washroom: 1 to 2 stalls/fixtures
- Passive fuel cell technology consistently delivers odor-neutralizing fragrance without the need for batteries



The TCell™ dispenser uses battery-free fuel-cell technology and does not contain propellant's or harmful VOC's



1793546



1793547



1793548

TCell™ Dispensers & Accessories

NO.	DESCRIPTION	U.S. DIMENSIONS	U.S. SHIP WT/CASE	U.S. CASE CUBE	METRIC DIMENSIONS	METRIC SHIP WT/CASE	METRIC CASE CUBE	CASE PACK
1793546	TCell™ Dispenser — Black	2.8" w x 5.4" h	3.5 lb	0.4 ft³	7.1 cm x 13.6 cm	1.6 kg	0.1 m³	12
1793547	TCell™ Dispenser — White	2.8" w x 5.4" h	3.5 lb	0.4 ft³	7.1 cm x 13.6 cm	1.6 kg	0.1 m³	12
1793548	TCell™ Dispenser — Chrome	2.8" w x 5.4" h	3.5 lb	0.4 ft³	7.1 cm x 13.6 cm	1.6 kg	0.1 m³	12
400845	TCell™ Dispenser Key	1.5" w x 0.8" h x 0.04" l	0.7 lb	0.008 ft³	4.0 cm x 1.9 cm x 0.1 cm	0.3 kg	0.0003 m³	50



IMAGE:
Continuous dispensing of high-quality fragrance and odor neutralizer provides a consistent feeling of cleanliness



COST-IN-USE:
Cost-effective refills deliver up to 3 of odor control that's superior to competitive systems

TCell™ Refills

Last up to 60 or 90 days based on program settings



FG402112



FG402113

NO.	DESCRIPTION	FRAGRANCE FAMILY	U.S. SHIP WT/CASE	U.S. CASE CUBE	METRIC SHIP WT/CASE	METRIC CASE CUBE	CASE PACK
FG402112	TCell™ Refill — Blue Splash	Fougère	2.0 lb	0.1 ft³	0.9 kg	0.03 m³	6
FG402113	TCell™ Refill — Citrus	Citrus	2.0 lb	0.1 ft³	0.9 kg	0.03 m³	6
FG402369	TCell™ Refill — Mango Blossom	Fruity	2.0 lb	0.1 ft³	0.9 kg	0.03 m³	6
FG402470	TCell™ Refill — Cucumber Melon	Fruity	2.0 lb	0.1 ft³	0.9 kg	0.03 m³	6
FG402498	TCell™ Refill — Pure™ Odor Neutralizer (Fragrance Free)	—	2.0 lb	0.1 ft³	0.9 kg	0.03 m³	6

When ordering products with **BOLD** color codes, please specify color code after the product number. Refer to the Standard Color Guide at the back of the catalog.



UTILITY REFUSE
AND RECYCLING

DECORATIVE REFUSE

CLEANING

MATERIAL HANDLING

WASHROOM

FOODSERVICE

ACCESSORIES
& INDEX



AutoFaucet®

AutoFaucet® sets the standard for reliability and user-friendly performance in automated faucet systems.

Touch-free activation eliminates cross-contamination to help reduce the spread of germs

- Surround Sensor™ technology creates an omnidirectional sensing zone, guaranteeing activation every time
- AutoFaucet® is low-lead-compliant
- "Dry" cam-gear technology (solenoid valve-free) ensures trouble-free operation to reduce maintenance
- Long battery life—400,000 cycles or 3 years (4 "D" batteries included)
- Also available with optional AC power adapter
- Standard 0.5 gpm aerator helps conserve water and reduce negative impact on the environment
- All models come supplied with an auto open line purge feature that eliminates stagnant water and bacterial growth



ADA COMPLIANT

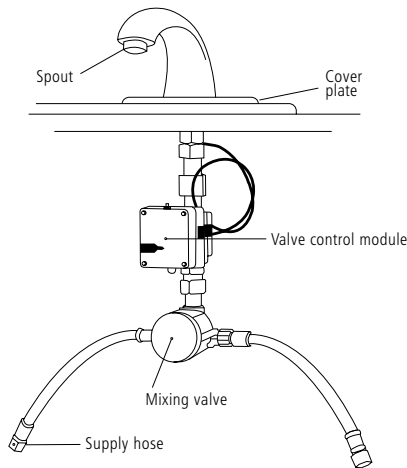

Provides water savings by dispensing water on demand.

**MILANO****Surround
Sensor™**

Surround Sensor™ Technology creates an omnidirectional sensing zone, guaranteeing activation every time.

All models come supplied with an auto open line purge feature that eliminates stagnant water and bacterial growth.



When ordering products with **BOLD** color codes, please specify color code after the product number. Refer to the Standard Color Guide at the back of the catalog.



	Finish	Single Hole Mount	4" Center Set	8" Center Set	Flow Rate (GPM)	Valve Control Module	Hot/Cold Supply Hoses	Mixing Valve	Thermostatic Mixing Valve
MILANO 	Polished Chrome	1782742	1782743	1782744	0.5 aerated	●	●	●	
	Polished Chrome	1818966	1818967	1818968	0.5 aerated	●	●		●

AutoFaucet® Single Hole Mounts

NO.	DESCRIPTION	U.S. DIMENSIONS	U.S. SHIP WT/CASE	U.S. CASE CUBE	METRIC DIMENSIONS	METRIC SHIP WT/CASE	METRIC CASE CUBE	KIT	CASE PACK
1782742	Milano - Polished Chrome	6.5" l x 2.1" w x 3.8" h	7.0 lb	0.3 ft³	16.5 cm x 5.4 cm x 9.5 cm	3.2 kg	0.01 m³	1	1
1818966	Milano - Polished Chrome	6.5" l x 2.1" w x 3.8" h	7.0 lb	0.3 ft³	16.5 cm x 5.4 cm x 9.5 cm	3.2 kg	0.01 m³	2	1

AutoFaucet® 4" Center Sets

NO.	DESCRIPTION	U.S. DIMENSIONS	U.S. SHIP WT/CASE	U.S. CASE CUBE	METRIC DIMENSIONS	METRIC SHIP WT/CASE	METRIC CASE CUBE	KIT	CASE PACK
1782743	Milano - Polished Chrome	6.5" l x 2.1" w x 3.8" h	7.0 lb	0.3 ft³	16.5 cm x 5.4 cm x 9.5 cm	3.2 kg	0.01 m³	1	1
1818967	Milano - Polished Chrome	6.5" l x 2.1" w x 3.8" h	7.0 lb	0.3 ft³	16.5 cm x 5.4 cm x 9.5 cm	3.2 kg	0.01 m³	2	1

AutoFaucet® 8" Center Sets

NO.	DESCRIPTION	U.S. DIMENSIONS	U.S. SHIP WT/CASE	U.S. CASE CUBE	METRIC DIMENSIONS	METRIC SHIP WT/CASE	METRIC CASE CUBE	KIT	CASE PACK
1782744	Milano - Polished Chrome	6.5" l x 2.1" w x 3.8" h	7.0 lb	0.3 ft³	16.5 cm x 5.4 cm x 9.5 cm	3.2 kg	0.01 m³	1	1
1818968	Milano - Polished Chrome	6.5" l x 2.1" w x 3.8" h	7.0 lb	0.3 ft³	16.5 cm x 5.4 cm x 9.5 cm	3.2 kg	0.01 m³	2	1

All faucets are low lead compliant and come with a 0.5 GPM aerator

Kit 1 Includes: spout, valve control module, mixing valve, and hot/cold supply hoses (3/8" comp. x 3/8" comp. x 12" length)

Kit 2 Includes: spout, valve control module, thermostatic mixing valve, and hot/cold supply hoses (3/8" comp. x 3/8" comp. x 12" length)

AutoFlush® Sidemount

Sidemount style allows for easy installation by replacing current flush handle.

- Smart Object Infrared Technology manages flushing automation for world-class reliability
- Promotes good hygiene by eliminating potential points of cross-contamination
- Prevents odors by ensuring fixtures are flushed at least once a day with the 24 hour courtesy flush
- No water shutoff is required during installation
- Patented Dry Cam-Gear technology controls water flow, ensures worry-free operation, and eliminates solenoid valves to prevent costly repairs
- Battery reserve feature allows 9,000 flushes after low battery indicator begins flashing
- Angled lens design combined with advanced sensor technology guarantees activation even with the toilet seat raised
- Courtesy Flush Button allows fixture to be easily flushed when needed
- Long battery life lasts more than three years or up to 100,000 flushes (4 "C" batteries included)



SCAN FOR
INSTALLATION
VIDEOS



ADA COMPLIANT

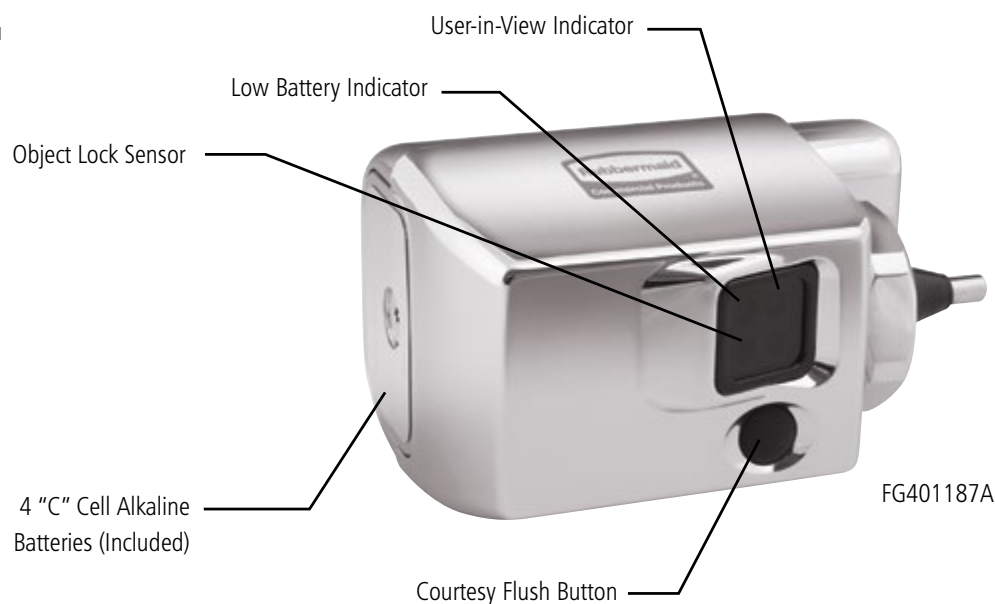

AutoFlush® Sidemount

NO.	DESCRIPTION	U.S. DIMENSIONS	U.S. SHIP WT/CASE	U.S. CASE CUBE	METRIC DIMENSIONS	METRIC SHIP WT/CASE	METRIC CASE CUBE	CASE PACK
FG401187A	AutoFlush® Sidemount for Sloan or Zurn Valves - Polished Chrome	4.8" l x 3.3" w x 2.8" h	2.3 lb	0.2 ft ³	12.0 cm x 8.4 cm x 7.1 cm	1.0 kg	0.004 m ³	1
FG401206A	AutoFlush® Sidemount for Coyne & Delany Flushboy Valves - Polished Chrome	4.8" l x 3.3" w x 2.8" h	2.3 lb	0.2 ft ³	12.0 cm x 8.4 cm x 7.1 cm	1.0 kg	0.004 m ³	1

Sidemount Adapters

NO.	DESCRIPTION	U.S. DIMENSIONS	U.S. SHIP WT/CASE	U.S. CASE CUBE	METRIC DIMENSIONS	METRIC SHIP WT/CASE	METRIC CASE CUBE	CASE PACK
401096	AutoFlush® High Mount Adapter Kit	4.8" l x 3.3" w x 2.8" h	2.3 lb	0.2 ft ³	12.0 cm x 8.4 cm x 7.1 cm	1.0 kg	0.004 m ³	1
401165	AutoFlush® Crane Valve Adapter Kit	4.8" l x 3.3" w x 2.8" h	2.3 lb	0.2 ft ³	12.0 cm x 8.4 cm x 7.1 cm	1.0 kg	0.004 m ³	1
401239	AutoFlush® Teck Valve Adapter	4.8" l x 3.3" w x 2.8" h	2.3 lb	0.2 ft ³	12.0 cm x 8.4 cm x 7.1 cm	1.0 kg	0.004 m ³	1
401477	AutoFlush® Tempus Valve Adapter	4.8" l x 3.3" w x 2.8" h	2.3 lb	0.2 ft ³	12.0 cm x 8.4 cm x 7.1 cm	1.0 kg	0.004 m ³	1

When ordering products with **BOLD** color codes, please specify color code after the product number. Refer to the Standard Color Guide at the back of the catalog.

AutoFlush® Clamp

Retrofit solution allows for easy installation directly over current flush handle.

- Smart Object Infrared Technology manages flushing automation for world-class reliability
- Promotes good hygiene by eliminating potential points of cross-contamination
- Prevents odors by ensuring fixtures are flushed at least once a day with the 24 hour courtesy flush
- No water shutoff is required during installation
- Battery reserve feature allows 9,000 flushes after low battery indicator begins flashing
- Combines an angled-lens design with advanced sensor technology that activates even when the toilet seat is raised
- Courtesy Flush Button allows fixture to be easily flushed when needed
- Long battery life, 3+ years or up to 60,000 flushes (4 "C" batteries included)



Simply slides over existing handle



SCAN FOR
INSTALLATION
VIDEOS



ADA COMPLIANT



FG401805A



HEALTH & WELLNESS:

Touch-free, sensor-activation eliminates potential cross-contamination and promotes good hygiene



IMAGE:

Automated flushing after every use helps prevent odors and ensures that the washroom always looks presentable

AutoFlush® Clamp

NO.	DESCRIPTION	U.S. DIMENSIONS	U.S. SHIP WT/CASE	U.S. CASE CUBE	METRIC DIMENSIONS	METRIC SHIP WT/CASE	METRIC CASE CUBE	CASE PACK
FG401805A	AutoFlush® Clamp - Polished Chrome	5.3" l x 3.6" w x 3.6" h	1.5 lb	0.1 ft³	13.5 cm x 9.0 cm x 9.2 cm	0.7 kg	0.004 m³	1

Clamp Adapters

NO.	DESCRIPTION	U.S. DIMENSIONS	U.S. SHIP WT/CASE	U.S. CASE CUBE	METRIC DIMENSIONS	METRIC SHIP WT/CASE	METRIC CASE CUBE	CASE PACK
401972	AutoFlush® Coyne & Delany/Crane Rex Adapter Kit	5.3" l x 3.6" w x 3.6" h	1.5 lb	0.1 ft³	13.5 cm x 9.0 cm x 9.2 cm	0.7 kg	0.004 m³	1
401973	AutoFlush® Canadian Adapter Kit (Crane, Teck, Tempus)	5.3" l x 3.6" w x 3.6" h	1.5 lb	0.1 ft³	13.5 cm x 9.0 cm x 9.2 cm	0.7 kg	0.004 m³	1
4870577	AutoFlush® Power Adapter Kit	5.3" l x 3.6" w x 3.6" h	1.5 lb	0.1 ft³	13.5 cm x 9.0 cm x 9.2 cm	0.7 kg	0.004 m³	1

AutoClean®

AutoClean® Systems deliver powerful formulas that attack and eliminate odors at the source—automatically cleaning fixture surfaces, day and night.

- Easy in-line installation allows cleaning solution to reach the hard to clean areas, such as rim holes, ensuring that the whole fixture is cleaned
- Refills deliver consistent metered dosage of Purinel® SC to prevent buildup of calcium in pipes and scaling
- Flexible programming options: up to 90-day refill cycle settings
- Industry-leading battery life of up to 3 years



SCAN FOR
INSTALLATION &
PROGRAMMING
VIDEO



ADA COMPLIANT



FG400509

AutoClean® Dispensers & Accessories*

NO.	DESCRIPTION	U.S. DIMENSIONS	U.S. SHIP WT/CASE	U.S. CASE CUBE	METRIC DIMENSIONS	METRIC SHIP WT/CASE	METRIC CASE CUBE	CASE PACK
FG500409	AutoClean® LED Dispenser — Chrome (Kit w/ 1/4" Connector)	12.5" l x 1.3" w x 6.8" h	4.0 lb	0.2 ft ³	31.8 cm x 3.2 cm x 17.1 cm	1.8 kg	0.01 m ³	1
FG500410	AutoClean® LED Dispenser — Chrome (Kit w/ 1/2" Connector)	12.5" l x 1.3" w x 6.8" h	4.0 lb	0.2 ft ³	31.8 cm x 3.2 cm x 17.1 cm	1.8 kg	0.01 m ³	1
400845	AutoClean® Dispenser Key	1.5" l x 0.8" w x 0.04" h	0.7 lb	0.008 ft ³	4.0 cm x 1.9 cm x 0.1 cm	0.3 kg	0.0003 m ³	50

*Kits contain: AutoClean® Dispenser, Mounting Hardware, Batteries, Connection Kit, and Stainless Steel Connection Tube.

**IMAGE:**

Ensures that fixtures are always clean, odor-free, and fresh-smelling, leaving patrons with a positive impression

**COST-IN-USE:**

Specialized refills maintain drain health by preventing calcium scaling in pipes and potential plumbing problems

**HEALTH & WELLNESS:**

Refills clean and help reduce bacteria growth on fixture surfaces



FG400586



FG401532

AutoClean® Refills

Last up to 60 days based on program settings

NO.	DESCRIPTION	U.S. DIMENSIONS	U.S. SHIP WT/CASE	U.S. CASE CUBE	METRIC DIMENSIONS	METRIC SHIP WT/CASE	METRIC CASE CUBE	CASE PACK
FG400586	Purinel® SC — Drain Maintainer & Cleaner	1.8" l x 3.9" w x 5.9" h	4.9 lb	0.2 ft ³	4.5 cm x 9.9 cm x 14.9 cm	2.2 kg	0.01 m ³	6
FG401532	AutoClean® Cleaner & Deodorizer Refill — Mandarin Orange	1.8" l x 3.9" w x 5.9" h	4.9 lb	0.2 ft ³	4.5 cm x 9.9 cm x 14.9 cm	2.2 kg	0.01 m ³	6

Clean Seat

Clean washroom surfaces with convenient wall-mounted dispensing system.

- Specially-treated coating on pushbar reduces cross-contamination on handle
- Foam refill dispenses 1000 shots of 0.4mL per dose; Spray refill dispenses 2000 shots of 0.2mL per dose
- Alcohol-based solution removes dirt and bacteria and eliminates the need for messy and awkward seat covers
- Mount anywhere in the washroom to remove dirt and grime on surfaces, such as toilet seats and baby changing stations
- Helps eliminate toilet clogging from covers and excess toilet paper



ADA COMPLIANT



FG402310



Just spray the solution on a toilet tissue, and then wipe the surfaces clean. Handle and seat are hygienic and ready for use in seconds.

Clean Seat Dispensers

NO.	DESCRIPTION	U.S. DIMENSIONS	U.S. SHIP WT/CASE	U.S. CASE CUBE	METRIC DIMENSIONS	METRIC SHIP WT/CASE	METRIC CASE CUBE	CASE PACK
FG402310	Clean Seat Foam 400 mL Dispenser — White	5.5" l x 4.8" w x 8.0" h	12.0 lb	1.8 ft ³	14.0 cm x 12.1 cm x 20.3 cm	5.4 kg	0.1 m ³	12



PRODUCTIVITY:

Bag-in-a-box design makes refills easy to store and quick to handle



FG402312



FG402537

Clean Seat Refills

Foam refills deliver up to 1,000 doses per refill, and spray refills deliver up to 2,000 doses per refill

NO.	DESCRIPTION	U.S. SIZE	U.S. SHIP WT/CASE	U.S. CASE CUBE	METRIC SHIP WT/CASE	METRIC CASE CUBE	CASE PACK
FG402312	Clean Seat Foam Refill	400 mL	11.9 lb	0.5 ft ³	5.4 kg	0.01 m ³	12
FG402537	Clean Seat Spray Refill	400 mL	11.0 lb	0.4 ft ³	5.0 kg	0.01 m ³	12

Baby Changing Station

Offers a secure baby changing solution with best-in-class durability and convenience. Horizontal and vertical baby changing stations meet all applicable ASTM, ADA, FDA, and EN global safety regulations and standards.

- Specially-treated surface helps reduce the risk of cross-contamination
- Opens conveniently with one hand
- Built-in shelf and liner storage holds up to 40 disposable liquid-barrier liners
- Easy-reach hooks securely hold diaper bags, purses, and supplies



DIN EN 12221-1:2013
DIN EN 12221-2:2013
AFPS GS 2014:01 PAK



FG781888



FG781888



FG781988

NO.	COLOR	DESCRIPTION	U.S. DIMENSIONS	U.S. SHIP WT/CTN	METRIC DIMENSIONS	METRIC SHIP WT/CTN	PACK
FG781788	WHT	Protective Liners for Baby Changing Stations Laminated 2-ply Tissue Paper	13.3" l x 5.5" w x 0.0" h	4.8 lb	33.7 cm x 14.0 cm x 0.0 cm	2.2 kg	1 (320)
FG781888	LPLAT	Baby Changing Station - Horizontal	33.3" l x 21.5" w x 4.0" h	23.5 lb	84.5 cm x 54.6 cm x 10.2 cm	10.7 kg	1
FG781988	LPLAT	Baby Changing Station - Vertical	23.0" l x 34.1" w x 4.0" h	25.0 lb	58.4 cm x 86.6 cm x 10.2 cm	11.3 kg	1

When ordering products with **BOLD** color codes, please specify color code after the product number. Refer to the Standard Color Guide at the back of the catalog.

Sanitary Bin

Offers a space-saving and easy-to-service option for sanitary waste disposal.
Space-saving and easy to service for sanitary waste disposal.

- Tight-sealing lids help contain odors
- Removable rigid liner keeps bin dry and makes bag maintenance easier
- Disposable bags allow for convenient removal of waste



FG614100



FG614000

NO.	COLOR	DESCRIPTION	U.S. DIMENSIONS	U.S. SHIP WT/CTN	METRIC DIMENSIONS	METRIC SHIP WT/CTN	MATERIAL TYPE	PACK
FG614000	WHT	Sanitary Bin with Rigid Liner	10.8" l x 5.3" w x 12.5" h	2.6 lb	27.3 cm x 13.3 cm x 31.8 cm	1.2 kg	Plastic	1
FG614100	0000	Waxed Bags for Sanitary Bin	8.8" l x 8.5" h	6.2 lb	22.2 cm x 21.6 cm	2.8 kg		1 (250)

Safti-Grip® Bath Mat

Perfect for shower stall or bathtub.

- Suction-backed to stay firmly in place
- Latex-free construction



1982724

NO.	COLOR	DESCRIPTION	U.S. DIMENSIONS	U.S. SHIP WT/CTN	METRIC DIMENSIONS	METRIC SHIP WT/CTN	PACK
1982724	White	Safti-Grip® Bath Mat - Medium	22.5" l x 14.0" w	4.9 lb	57.2 cm x 35.6 cm	2.2 kg	12
1982726	White	Safti-Grip® Bath Mat - Large	28.0" l x 16.0" w	8.9 lb	71.1 cm x 40.6 cm	4.0 kg	12
1982729	White	Safti-Grip® Bath Mat - X-Large	36.0" l x 18.0" w	12.4 lb	91.4 cm x 45.7 cm	5.6 kg	12

UTILITY REFUSE
AND RECYCLING



FOODSERVICE

DECORATIVE REFUSE

CLEANING

MATERIAL HANDLING

WASHROOM

FOODSERVICE

ACCESSORIES
& INDEX



FG360288WHT



FG196200

STORAGE

ProSave® Ingredient Management System..... 214
 Rack for Shelf Ingredient Bins 215
 BRUTE® GreensKeeper® Containers 216
 ProSave® Ingredient Management System Rotating Lids 216
 Food Boxes 218
 Space-Saving Square Containers..... 220
 Round Storage Containers 221

PREPARATION

High-Heat Scrapers and Spoons..... 222
 Cold Scrapers and Spoons 222
 Bouncer® Measuring Cups 223
 Bouncer® Scoops..... 223

MONITORING

Thermometers 224

TRANSPORT

ProServe® Rack..... 225

TABLE SERVICE

Bus/Tote Boxes..... 227
 Cutlery Bin..... 227

YOUTH SERVICE

Sturdy Chair™ Youth Seats 228

UTILITY REFUSE
AND RECYCLING

DECORATIVE REFUSE

CLEANING

MATERIAL HANDLING

WASHROOM

FOODSERVICE

ACCESSORIES
& INDEX

FOODSERVICE

ProSave® Ingredient Management System INGREDIENT BINS

Improved productivity through integrated lid and scoop system.

- Integrated lid and measuring scoop allows for quick one-handed access to stored ingredients
- Clear window for fast ingredient identification and inventory management
- Certified to NSF/ANSI/3-A and 2 Standards
- Commercial dishwasher-safe
- Complies with FDA Food code 3-304.12 to increase inspection score
- One-handed access while stacked improves space efficiency
- FIFO (First In First Out) barrier for proper food rotation improves food quality



FG360088
400 Cups
124 lb flour



FG360288
500 Cups
154 lb flour



FG360388
600 Cups
188 lb flour



FG9G6000
40 Cups
13 lb flour



FG9G5700
100 Cups
25 lb flour



FG9G5800
200 Cups
50 lb flour



Dedicated internal scoop, included with bin, has proper storage to meet safety compliance.



Speed up food preparation with one-handed access which results in 65% productivity savings



Ensure proper food rotation with FIFO barrier.

ProSave® Ingredient Bins

NO.	COLOR	DESCRIPTION	U.S. CAPACITY (GAL/CU. FT)	U.S. FLOUR/ SUGAR CAPACITY	DIMENSIONS	U.S. SHIP WT/CTN	METRIC CAPACITY	METRIC FLOUR/SUGAR CAPACITY	METRIC DIMENSIONS	METRIC SHIP WT/CTN	PACK
FG9G6000	WHT	40-Cup Shelf Ingredient Bin with ½-Cup Scoop	2.6 gal 0.3 cu ft	Flour: 13.0 lb Sugar: 17.0 lb	15.0" l x 11.8" w x 8.5" h	3.3 lb	0.1 m³	Flour: 5.9 kg Sugar: 7.7 kg	38.1 cm x 29.8 cm x 21.6 cm	1.5 kg	1
FG9G5700	WHT	100-Cup Shelf Ingredient Bin with 2-Cup Scoop	6.3 gal 0.8 cu ft	Flour: 25.0 lb Sugar: 50.0 lb	23.5" l x 11.5" w x 16.9" h	13.3 lb	0.1 m³	Flour: 11.3 kg Sugar: 22.7 kg	59.7 cm x 29.2 cm x 42.9 cm	6.0 kg	1
FG9G5800	WHT	200-Cup Shelf Ingredient Bin with 2-Cup Scoop	12.6 gal 1.7 cu ft	Flour: 50.0 lb Sugar: 100.0 lb	23.5" l x 19.2" w x 16.9" h	18.5 lb	0.1 m³	Flour: 22.7 kg Sugar: 45.4 kg	59.7 cm x 48.8 cm x 42.9 cm	8.4 kg	1
FG360088	WHT	Slant-Front Ingredient Bin with Sliding Lid and 32-oz (0.9-L) Scoop	20.5 gal 2.8 cu ft	Flour: 124.0 lb Sugar: 158.0 lb	29.3" l x 13.1" w x 28.0" h	27.7 lb	0.1 m³	Flour: 56.3 kg Sugar: 72.7 kg	74.3 cm x 33.4 cm x 71.1 cm	12.6 kg	1
FG360288	WHT	Slant-Front Ingredient Bin with Sliding Lid and 32-oz (0.9-L) Scoop	26.2 gal 3.5 cu ft	Flour: 154.0 lb Sugar: 197.0 lb	29.5" l x 15.5" w x 28.0" h	32.7 lb	0.1 m³	Flour: 69.9 kg Sugar: 89.4 kg	74.9 cm x 39.4 cm x 71.1 cm	14.8 kg	1
FG360388	WHT	Slant-Front Ingredient Bin with Sliding Lid and 32-oz (0.9-L) Scoop	30.8 gal 4.1 cu ft	Flour: 188.0 lb Sugar: 240.0 lb	29.8" l x 18.0" w x 28.0" h	38.7 lb	0.1 m³	Flour: 85.3 kg Sugar: 108.9 kg	75.6 cm x 45.7 cm x 71.1 cm	17.6 kg	1

ProSave® Lids With Scoops

NO.	COLOR	DESCRIPTION	U.S. DIMENSIONS	FITS RUBBERMAID® INGREDIENT BIN	U.S. SHIP WT/CTN	METRIC DIMENSIONS	METRIC SHIP WT/CTN	PACK
FG9F7700	CLR	Sliding Lid with 32-oz (0.9-L) Scoop for FG360088 Ingredient Bin	29.0" l x 12.1" w x 1.9" h	FG360088	5.8 lb	73.7 cm x 30.7 cm x 4.8 cm	2.6 kg	1
FG9F7800	CLR	Sliding Lid with 32-oz (0.9-L) Scoop for FG360288 Ingredient Bin	29.0" l x 14.5" w x 1.9" h	FG360288	6.5 lb	73.7 cm x 36.8 cm x 4.8 cm	2.9 kg	1
FG9F7900	CLR	Sliding Lid with 32-oz (0.9-L) Scoop for FG360388 Ingredient Bin	29.0" l x 17.2" w x 1.9" h	FG360388	7.4 lb	73.7 cm x 43.7 cm x 4.8 cm	3.4 kg	1

When ordering products with **BOLD** color codes, please specify color code after the product number. Refer to the Standard Color Guide at the back of the catalog.

Rack for Shelf Ingredient Bins

Store and transport bins efficiently throughout the operation.

- Maximize space for kitchen preparation and storeroom for ingredient storage
- Racks designed to hold and transport 200 lbs. (90.7 kg) per shelf
- 5" nonmarking casters for safe transport
- Locating bar on shelf to secure bins during transport
- Customize your shelf ingredient bins in storage with different configurations



FG9G8000
Rack
50" Wide

Rack For ProSave® Shelf Ingredient Bins

NO.	COLOR	DESCRIPTION	U.S. DEPTH	U.S. WIDTH	U.S. HEIGHT	CASE WEIGHT (LBS)	METRIC DEPTH	METRIC WIDTH	METRIC HEIGHT	CASE WEIGHT (KG)	CASE PACK
FG9G8000	CHRM	Mobile Rack for Shelf Ingredient Bins, 50" wide	18.0"	50.0"	67.2"	76.0 lb	45.7 cm	127.0 cm	170.5 cm	34.5 kg	1

Scoops

NO.	COLOR	DESCRIPTION	CAPACITY (OZ/LITERS)	U.S. LENGTH	U.S. WIDTH	U.S. HEIGHT	CASE WEIGHT (LBS)	METRIC LENGTH	METRIC WIDTH	METRIC HEIGHT	CASE WEIGHT (KG)	CASE PACK
FG9F7500*	CLR	Bouncer® Contour Scoop for FG360088, FG360288, FG360388 Ingredient Bins and FG9F Prosave Sliding Lids	32.0 oz (1.0 L)	10.8"	4.8"	4.7"	4.2 lb	27.4 cm	12.2 cm	12.0 cm	1.9 kg	6
FG9F7600*	CLR	Bouncer® Contour Scoop for FG360088, FG360288, FG360388 Ingredient Bins and FG9F Prosave Sliding Lids	64.0 oz (1.9 L)	13.7"	5.9"	4.7"	6.2 lb	34.8 cm	15.0 cm	11.9 cm	2.8 kg	6

*Certified to NSF Std. 2.

BRUTE® GreensKeeper® Containers

For cleaning and storing any fruit or vegetable.

- All-in-one wash, drain, crisp, and storage system that aids compliance with HACCP guidelines
- Removable dolly allows easy transport
- Assists in complying with FDA Code 3-302, 15 for Washing Fruits and Vegetables



FG263600

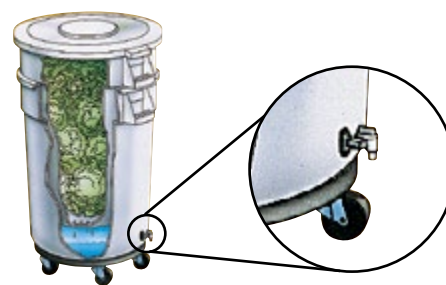

NO.	COLOR	DESCRIPTION	U.S. CAPACITY	U.S. DIMENSIONS	U.S. SHIP WT/CTN	METRIC CAPACITY	METRIC DIMENSIONS	METRIC SHIP WT/CTN	LETTUCE HEADS	CASE PACK
FG263600	WHT	GreensKeeper® Container with Lid and Dolly	32.0 gal	25.0" dia x 38.5" h	29.1 lb	121.1 L	63.5 cm dia x 97.8 cm	13.2 kg	49-52	1

ProSave® Ingredient Management System Rotating Lids

Designed for quick one-handed access to ingredients in a high-production facility.

- Rotating lid allows for one-handed access
- Dedicated internal scoop storage complies with food code for safe access
- Hook options for 32.0- and 64.0-oz. Contour Scoop allows for ingredient access flexibility
- Clear windows for fast ingredient identification and inventory management
- Certified to NSF/ANSI/3-A and 2 Standards
- Commercial dishwasher-safe

NSF



Improve safety compliance with dedicated internal scoop storage.



Enhance food production efficiency with rotating clear lid.

FG9G7600 / FG9G7700 / FG9G7800
Rotating Lid

NO.	COLOR	DESCRIPTION	DEPTH	WIDTH	HEIGHT	CASE WEIGHT (LB TO KG)	CASE PACK
FG9G7600	WHT	Rotating Lid with 2-Cup Scoop (fits FG261000WHT Vented BRUTE® Container)	17.0"	17.0"	4.8"	3.0 lb (1.4 kg)	1
FG9G7700	WHT	Rotating Lid with 3-Cup Scoop (fits FG262000WHT Vented BRUTE® Container)	20.8"	20.8"	5.0"	4.3 lb (2.0 kg)	1
FG9G7800	WHT	Rotating Lid with 4-Cup Scoop (fits FG263200WHT Vented BRUTE® Container and FG263600WHT BRUTE® GreensKeeper® Container)	23.5"	23.5"	5.3"	5.3 lb (2.4 kg)	1

When ordering products with **BOLD** color codes, please specify color code after the product number. Refer to the Standard Color Guide at the back of the catalog.



UTILITY REFUSE
AND RECYCLING

DECORATIVE REFUSE

CLEANING

MATERIAL HANDLING

WASHROOM

FOODSERVICE

ACCESSORIES
& INDEX

Food Boxes

Durable storage solution for food as it flows throughout your facility.

- Crystal-clear material is stain- and odor-resistant and allows for visibility of food contents and quality
- White polyethylene containers provide durable and practical solution
- Texturing on corners and base reduces scratching
- Labeling window visible on bases and lids for date and information coding
- Available in standard sizes of 18.0" x 12.0" and 26.0" x 18.0"

SOLID FLAT LIDS

- Durable lids snap tightly into place during transport and keep foods fresh
- Use lid as a tray when displayed upside down
- Available in crystal-clear material or white polyethylene



FG330000 and F330200



FG330600

FG330800

FG330000

FG332800

FG330100



FG350400

FG350800

FG350000

FG352800

FG350100

Crystal-Clear Food Boxes and Lids

NO.	COLOR	DESCRIPTION	U.S. CAPACITY	U.S. DIMENSIONS	U.S. SHIP WT/CTN	METRIC CAPACITY	METRIC DIMENSIONS	METRIC SHIP WT/CTN	CASE PACK
FG330600	CLR	Food/Tote Box	5.0 gal	26.0" l x 18.0" w x 3.5" d	21.5 lb	18.9 L	66.0 cm x 45.7 cm x 8.9 cm	9.8 kg	6
FG330800	CLR	Food/Tote Box	8.5 gal	26.0" l x 18.0" w x 6.0" d	30.0 lb	32.2 L	66.0 cm x 45.7 cm x 15.2 cm	13.6 kg	6
FG330000	CLR	Food/Tote Box	12.5 gal	26.0" l x 18.0" w x 9.0" d	42.9 lb	47.3 L	66.0 cm x 45.7 cm x 22.9 cm	19.5 kg	6
FG332800	CLR	Food/Tote Box	16.6 gal	26.0" l x 18.0" w x 12.0" d	54.9 lb	62.9 L	66.0 cm x 45.7 cm x 30.5 cm	24.9 kg	6
FG330100	CLR	Food/Tote Box	21.5 gal	26.0" l x 18.0" w x 15.0" d	66.9 lb	81.4 L	66.0 cm x 45.7 cm x 38.1 cm	30.3 kg	6
FG330200	CLR	Lid for FG330000, FG330100, FG330600, FG330800, FG332800 Food/Tote Boxes	N/A	26.0" l x 18.0" w	16.9 lb	N/A	66.0 cm x 45.7 cm	7.7 kg	6
FG330700	CLR	Food/Tote Box	2.0 gal	18.0" l x 12.0" w x 3.5" d	10.4 lb	7.6 L	45.7 cm x 30.5 cm x 8.9 cm	4.7 kg	6
FG330900	CLR	Food/Tote Box	3.5 gal	18.0" l x 12.0" w x 6.0" d	18.0 lb	13.2 L	45.7 cm x 30.5 cm x 15.2 cm	8.2 kg	6
FG330400	CLR	Food/Tote Box	5.0 gal	18.0" l x 12.0" w x 9.0" d	22.1 lb	18.9 L	45.7 cm x 30.5 cm x 22.9 cm	10.0 kg	6
FG331000	CLR	Lid for FG330400, FG330700, FG330900 Food/Tote Boxes	N/A	18.0" l x 12.0" w	7.6 lb	N/A	45.7 cm x 30.5 cm	3.4 kg	6
FG330300	CLR	Colander for Tote Boxes 6" deep or greater	N/A	26.0" l x 18.0" w x 5.0" d	26.7 lb	N/A	66.0 cm l x 45.7 cm w x 12.7 cm	12.2 kg	6

When ordering products with **BOLD** color codes, please specify color code after the product number. Refer to the Standard Color Guide at the back of the catalog.

Polyethylene Food Boxes and Lids

NO.	COLOR	DESCRIPTION	U.S. CAPACITY	U.S. DIMENSIONS	U.S. SHIP WT/CTN	METRIC CAPACITY	METRIC DIMENSIONS	METRIC SHIP WT/CTN	CASE PACK
FG350600	WHT	Food/Tote Box	5.0 gal	26.0" l x 18.0" w x 3.5" d	18.1 lb	18.9 L	66.0 cm x 45.7 cm x 8.9 cm	8.2 kg	6
FG350800	WHT	Food/Tote Box	8.5 gal	26.0" l x 18.0" w x 6.0" d	23.3 lb	32.2 L	66.0 cm x 45.7 cm x 15.2 cm	10.5 kg	6
FG350000	WHT	Food/Tote Box	12.5 gal	26.0" l x 18.0" w x 9.0" d	31.7 lb	47.3 L	66.0 cm x 45.7 cm x 22.9 cm	14.4 kg	6
FG352800	WHT	Food/Tote Box	16.6 gal	26.0" l x 18.0" w x 12.0" d	41.8 lb	62.9 L	66.0 cm x 45.7 cm x 30.5 cm	19.0 kg	6
FG350100	WHT	Food/Tote Box	21.5 gal	26.0" l x 18.0" w x 15.0" d	52.9 lb	81.4 L	66.0 cm x 45.7 cm x 38.1 cm	24.0 kg	6
FG350200	WHT	Lid for FG350000, FG350100, FG350600, FG350800, FG352800 Food/Tote Boxes	N/A	26.0" l x 18.0" w	14.8 lb	N/A	66.0 cm x 45.7 cm	6.7 kg	6
FG350700	WHT	Food/Tote Box	2.0 gal	18.0" l x 12.0" w x 3.5" d	8.2 lb	7.6 L	45.7 cm x 30.5 cm x 8.9 cm	3.7 kg	6
FG350900	WHT	Food/Tote Box	3.5 gal	18.0" l x 12.0" w x 6.0" d	14.0 lb	13.2 L	45.7 cm x 30.5 cm x 15.2 cm	6.4 kg	6
FG350400	WHT	Food/Tote Box	5.0 gal	18.0" l x 12.0" w x 9.0" d	17.2 lb	18.9 L	45.7 cm x 30.5 cm x 22.9 cm	7.8 kg	6
FG351000	WHT	Lid for FG350400, FG350700, FG350900 Food/Tote Boxes	N/A	18.0" l x 12.0" w	7.1 lb	N/A	45.7 cm x 30.5 cm	3.2 kg	6



Space-Saving Square Containers

Stackable containers store more in less space.

- Square containers store a minimum of 25% more on a shelf than round containers
- Available in break-resistant, crystal-clear material for visibility
- Manage food inventory with easy-to-read measurement graduations—red for quarts and blue for liters
- Durable handles for easy transport and drain holes for proper washing and drying
- Temperature range for clear containers: -40°F to 212°F (-40°C to 100°C)
- Temperature range for white containers: -20°F to 150°F (-29°C to 66°C)
- Assists in complying with HACCP guidelines
- NSF 3-A Meat and Poultry Equipment and NSF 2-certified
- Commercial dishwasher-safe



Polycarbonate Square Storage Containers



FG650900 / FG630200

FG650900 / FG630400

FG650900 / FG630600

FG650900 / FG630800

FG652300 / FG631200

FG652300 / FG631800

FG652300 / FG632200

Crystal-Clear Square Storage Containers

NO.	COLOR	DESCRIPTION	U.S. CAPACITY	U.S. DIMENSIONS	U.S. SHIP WT/CTN	METRIC CAPACITY	METRIC DIMENSIONS	METRIC SHIP WT/CTN	CASE PACK
FG630200	CLR	Space-Saving Square Container	2.0 qt	8.8" l x 8.8" w x 2.7" h	7.0 lb	1.9 L	22.2 cm x 22.4 cm x 6.8 cm	3.2 kg	12
FG630400	CLR	Space-Saving Square Container	4.0 qt	8.8" l x 8.8" w x 4.8" h	10.4 lb	3.8 L	22.2 cm x 22.4 cm x 12.1 cm	4.7 kg	12
FG630600	CLR	Space-Saving Square Container	6.0 qt	8.8" l x 8.8" w x 6.9" h	14.1 lb	5.7 L	22.2 cm x 22.4 cm x 17.6 cm	6.4 kg	12
FG630800	CLR	Space-Saving Square Container	8.0 qt	8.8" l x 8.8" w x 8.8" h	9.4 lb	7.6 L	22.2 cm x 22.4 cm x 22.2 cm	4.3 kg	6
FG631200	CLR	Space-Saving Square Container	12.0 qt	11.3" l x 10.5" w x 7.8" h	11.0 lb	11.4 L	28.7 cm x 26.7 cm x 19.7 cm	5.0 kg	6
FG631800	CLR	Space-Saving Square Container	18.0 qt	11.3" l x 10.5" w x 11.9" h	17.2 lb	17.0 L	28.7 cm x 26.7 cm x 30.3 cm	7.8 kg	6
FG632200	CLR	Space-Saving Square Container	22.0 qt	11.3" l x 10.5" w x 14.4" h	23.0 lb	20.8 L	28.7 cm x 26.7 cm x 36.7 cm	10.4 kg	6

Square Container Lids

Use color-coded storage containers and lids to keep uncooked foods like raw meat separate from ready-to-eat foods.

- Leak-resistant, snap-tight lids
- Corner pull tab for easy lid removal



COLOR AVAILABLE:



FG650900WHT

NO.	COLOR	DESCRIPTION	SIZE	U.S. DIMENSIONS	U.S. SHIP WT/CTN	METRIC DIMENSIONS	METRIC SHIP WT/CTN	CASE PACK
FG650900	WHT	Color-Coded Square Container Lid	Fits 2.0, 4.0, 6.0, & 8.0 qt	9.0" l x 8.5" w x 0.5" h	3.1 lb	228.6 mm x 215.1 mm x 13.0 mm	1.4 kg	12
FG652300	WHT	Color-Coded Square Container Lid	Fits 12.0, 18.0, & 22.0 qt	11.6" l x 10.7" w x 0.5" h	2.3 lb	293.7 mm x 271.3 mm x 13.2 mm	1.0 kg	6

When ordering products with **BOLD** color codes, please specify color code after the product number. Refer to the Standard Color Guide at the back of the catalog.

Round Storage Containers

Store food safely and efficiently.

- Stackable handled containers available in white polyethylene or semi-clear polypropylene for better visibility
- Temperature range: 35°F to 150°F (2°C to 66°C)
- NSF 3-A and NSF 2-certified
- Dishwasher-safe



FG572200 / FG572024

FG572200 / FG572100

FG572500 / FG572324

FG572500 / FG572400

FG573000 / FG572824

FG573000 / FG572900

Semi-Clear Polypropylene Round Storage Containers

NO.	COLOR	DESCRIPTION	U.S. CAPACITY	U.S. DIMENSIONS	U.S. SHIP WT/CTN	METRIC CAPACITY	METRIC DIMENSIONS	METRIC SHIP WT/CTN	CASE PACK
FG572024	CLR	Round Storage Container	2.0 qt	8.5" dia x 4.0" h	4.3 lb	1.9 L	21.6 cm dia x 10.2 cm	2.0 kg	12
FG572124	CLR	Round Storage Container	4.0 qt	8.5" dia x 7.8" h	7.4 lb	3.8 L	21.6 cm dia x 19.7 cm	3.4 kg	12
FG572324	CLR	Round Storage Container	6.0 qt	10.0" dia x 7.6" h	8.7 lb	5.7 L	25.4 cm dia x 19.4 cm	3.9 kg	12
FG572424	CLR	Round Storage Container	8.0 qt	10.0" dia x 10.6" h	11.9 lb	7.6 L	25.4 cm dia x 27.0 cm	5.4 kg	12
FG572624	CLR	Round Storage Container	12.0 qt	13.1" dia x 8.1" h	8.5 lb	11.4 L	33.3 cm dia x 20.6 cm	3.9 kg	6
FG572724	CLR	Round Storage Container	18.0 qt	13.1" dia x 11.9" h	11.6 lb	17.0 L	33.3 cm dia x 30.2 cm	5.3 kg	6
FG572824	CLR	Round Storage Container	22.0 qt	13.1" dia x 14.0" h	14.8 lb	20.8 L	33.3 cm dia x 35.6 cm	6.7 kg	6

Polyethylene Round Storage Containers

NO.	COLOR	DESCRIPTION	U.S. CAPACITY	U.S. DIMENSIONS	U.S. SHIP WT/CTN	METRIC CAPACITY	METRIC DIMENSIONS	METRIC SHIP WT/CTN	CASE PACK
FG572000	WHT	Round Storage Container	2.0 qt	8.5" dia x 4.0" h	4.3 lb	1.9 L	21.6 cm dia x 10.2 cm	2.0 kg	12
FG572100	WHT	Round Storage Container	4.0 qt	8.5" dia x 7.8" h	7.4 lb	3.8 L	21.6 cm dia x 19.7 cm	3.4 kg	12
FG572300	WHT	Round Storage Container	6.0 qt	10.0" dia x 7.6" h	8.7 lb	5.7 L	25.4 cm dia x 19.4 cm	3.9 kg	12
FG572400	WHT	Round Storage Container	8.0 qt	10.0" dia x 10.6" h	11.9 lb	7.6 L	25.4 cm dia x 27.0 cm	5.4 kg	12
FG572600	WHT	Round Storage Container	12.0 qt	13.1" dia x 8.1" h	8.5 lb	11.4 L	33.3 cm dia x 20.6 cm	3.9 kg	6
FG572700	WHT	Round Storage Container	18.0 qt	13.1" dia x 11.9" h	11.6 lb	17.0 L	33.3 cm dia x 30.2 cm	5.3 kg	6
FG572800	WHT	Round Storage Container	22.0 qt	13.1" dia x 14.0" h	15.2 lb	20.8 L	33.3 cm dia x 35.6 cm	6.9 kg	6
FG572900	WHT	Round Storage Container with Bail	22.0 qt	13.1" dia x 14.0" h	16.6 lb	20.8 L	33.3 cm dia x 35.6 cm	7.5 kg	6

Round Container Lids

Use color-coded storage containers and lids to keep uncooked foods like raw meat separate from ready-to-eat foods.

- Secure, leak-resistant lids
- Positive-lock lid (double-wall seal) with pull tabs



FG572200YEL

NO.	COLOR	DESCRIPTION	SIZE	U.S. DIMENSIONS	U.S. SHIP WT/CTN	METRIC DIMENSIONS	METRIC SHIP WT/CTN	CASE PACK
FG572200	YEL	Color-Coded Round Container Lid	Fits 4.0 qt	8.8" l x 8.8" w x 0.9" h	2.5 lb	223.5 mm x 223.5 mm x 22.9 mm	1.1 kg	12
FG572500	YEL	Color-Coded Round Container Lid	Fits 8.0 qt	10.3" l x 10.3" w x 1.0" h	3.2 lb	261.6 mm x 261.6 mm x 25.4 mm	1.5 kg	12
FG573000	YEL	Color-Coded Round Container Lid	Fits 12.0 qt	13.5" l x 13.5" w x 1.2" h	3.4 lb	343.5 mm x 343.5 mm x 30.5 mm	1.5 kg	6



High-Heat Scrapers and Spoons

All-purpose scrapers and spoons are a necessity in every kitchen.

- Silicone blade and nylon handle resist temperatures to 500°F/260°C and help prevent burns
- Clean-Rest™ feature keeps blade off countertops, reducing cross-contamination
- Notched scraper blade cleanly scrapes sides of pans
- Blades are stain-resistant and will not scratch pans
- NSF-certified and commercial dishwasher-safe

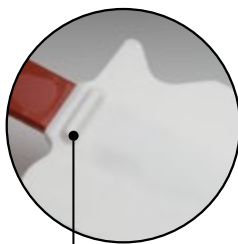

Clean-Rest™ reduces risk of cross-contamination.



Spoon



NO.	COLOR	DESCRIPTION	U.S. DIMENSIONS	U.S. SHIP WT/CTN	METRIC DIMENSIONS	METRIC SHIP WT/CTN	CASE PACK
FG196200	0000	Color Coded High-Heat Spatula (Red)	9.5" l	3.3 lb	24.1 cm	1.2 kg	24
FG196300	0000	Color Coded High-Heat Spatula (Red)	13.5" l	3.9 lb	34.3 cm	1.8 kg	24
FG196400	0000	High-Heat Scraper	16.5" l	7.0 lb	41.9 cm	3.2 kg	24
FG196600	RED	High-Heat Spoon Scraper	9.5" l	3.3 lb	24.1 cm	1.5 kg	24
FG196700	RED	High-Heat Spoon Scraper	13.5" l	6.6 lb	34.3 cm	3.0 kg	24
FG196800	RED	High-Heat Spoon Scraper	16.5" l	7.1 lb	41.9 cm	3.2 kg	24

Cold Scrapers and Spoons

Spoon, scrape, and spread with one easy tool.

- Blades are molded into handles for seamless construction that reduces buildup of dirt and bacteria
- Clean-Rest™ feature keeps blade off countertops, reducing cross-contamination
- NSF-certified and commercial dishwasher-safe



Clean-Rest™ reduces risk of cross-contamination.



Scraper



Spoon



NO.	COLOR	DESCRIPTION	U.S. DIMENSIONS	U.S. SHIP WT/CTN	METRIC DIMENSIONS	METRIC SHIP WT/CTN	CASE PACK
FG190100	WHT	Scraper	9.5" l	4.0 lb	24.1 cm	1.8 kg	36
FG190500	WHT	Scraper	13.5" l	8.0 lb	34.3 cm	3.6 kg	36
FG190600	WHT	Scraper	16.5" l	12.0 lb	41.9 cm	5.4 kg	36
FG193300	WHT	Spoon-Shaped Spatula	9.5" l	4.6 lb	24.1 cm	2.1 kg	36
FG193400	WHT	Spoon-Shaped Spatula	13.5" l	9.2 lb	34.3 cm	4.2 kg	36
FG193800	WHT	Spoon-Shaped Spatula	16.5" l	11.1 lb	41.9 cm	5.0 kg	36

Bouncer® Measuring Cups

Manage costly ingredients.

- Accurately measure liquid or dry ingredients to help save on food costs
- Break-resistant, crystal-clear material is durable
- Temperature range: -40°F to 212°F (-40°C to 100°C)
- Metric measurements marked in blue and cup measurements marked in red for easy-to-read measurements
- NSF-certified and commercial dishwasher-safe



NO.	COLOR	DESCRIPTION	U.S. CAPACITY	U.S. SHIP WT/CTN	METRIC CAPACITY	METRIC SHIP WT/CTN	CASE PACK
FG321000	CLR	Bouncer® Measuring Cup	1.0 cup	2.0 lb	0.2 L	0.9 kg	12
FG321500	CLR	Bouncer® Measuring Cup	1.0 pt	2.4 lb	0.5 L	1.1 kg	6
FG321600	CLR	Bouncer® Measuring Cup	1.0 qt	3.3 lb	0.9 L	1.5 kg	6
FG321700	CLR	Bouncer® Measuring Cup	2.0 qt	4.4 lb	1.9 L	2.0 kg	6
FG321800	CLR	Bouncer® Measuring Cup	4.0 qt	10.0 lb	3.8 L	4.5 kg	6

Bouncer® Scoops

Multipurpose scoops for use throughout food service operations.

- Durable crystal-clear material (FG288200, FG288400, FG288600) or break-resistant white polyethylene (FG288500) can be used for a variety of applications
- NSF-certified (FG288200, FG288400, FG288600 and FG9F7500) and commercial dishwasher-safe
- Bouncer® Contour Scoop (FG9F7500) is designed for the ProSave® Ingredient Bin System; the contoured design keeps hands away from food, reducing cross-contamination



FG288400 / FG288200 / FG288600

NO.	COLOR	DESCRIPTION	U.S. CAPACITY	U.S. SHIP WT/CTN	METRIC CAPACITY	METRIC SHIP WT/CTN	CASE PACK
FG288200*	CLR	Bouncer® Bar Scoop	6.0 oz	3.0 lb	0.2 L	1.4 kg	12
FG288400*	CLR	Bouncer® Utility Scoop	32.0 oz	6.4 lb	0.9 L	2.9 kg	12
FG288500	WHT	Utility Scoop	64.0 oz	3.4 lb	1.9 L	1.5 kg	6
FG9F7500*	CLR	Bouncer® Contour Scoop for FG360088, FG360288, FG360388 Ingredient Bins (32-oz scoop)	32.0 oz	4.2 lb	0.9 L	1.9 kg	6
FG9F7600*	CLR	Bouncer® Contour Scoop for FG360088, FG360288, FG360388 Ingredient Bins (64-oz scoop)	64.0 oz	6.2 lb	1.9 L	2.8 kg	6

*Certified to NSF Std. 2.



Thermometers

Reduce food waste by effectively monitoring temperatures.

- Easy-to-read dials

Refrigerator/Freezer and Oven Thermometers

- Hang or stand for easy installation
- Read both Fahrenheit and Celsius

Pocket Thermometers

- Read temperatures from 0 to 220 degrees Fahrenheit
- Include a protective sheath



FGR80DC



FGTHP220DS



FGTH0550

NO.	DESCRIPTION	U.S. DIMENSIONS	U.S. SHIP WT/CTN	METRIC DIMENSIONS	METRIC SHIP WT/CTN	CASE PACK
FGR80DC	Refridgerator/Freezer Thermometer (-20° – 80° F)	2.0" l x 4.5" w x 6.1" h	19.9 lb	5.1 cm x 11.4 cm x 15.5 cm	9.0 kg	144
FGTH0550	Oven Thermometer (60° – 580° F)	2.0" l x 4.6" w x 5.0" h	26.5 lb	5.1 cm x 11.6 cm x 12.7 cm	12.0 kg	144
FGTHP220DS	Pocket Thermometer (0° – 220° F), Dishwasher Safe	1.3" l x 2.3" w x 8.0" h	8.6 lb	3.2 cm x 5.7 cm x 20.3 cm	3.9 kg	144

ProServe® Rack

Increase efficiency by maximizing space, transportation, and storage.

- Versatile system specially designed to work with food pans, food boxes, and sheet pans
- Impact-resistant structural web plastic components stand up to the most demanding kitchens
- Designed with soft, round corners that are easy on the walls, doors, and equipment
- Stylish design and quiet handling moves food easily from kitchen to dining room, minimizing expensive labor costs
- USDA Meat and Poultry Group listed
- NSF-certified for cleanability
- Casters are 5.0" (12.7 cm) nonmarking, swivel-plate design (two are lockable)



Opening: 19^{3/16}" (50.32 cm)
Accommodates:

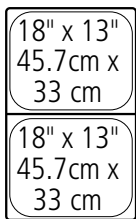
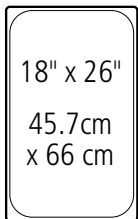

Food Box/
Sheet Pan

FG332000

NO.	COLOR	DESCRIPTION	PAN CAPACITY	U.S. DIMENSIONS	U.S. SHIP WT/CTN	METRIC DIMENSIONS	METRIC SHIP WT/CTN	CASE PACK
FG332000	BLA	ProServe® Rack (18-slot end loader for food boxes and sheet pans)	18	28.8" l x 23.8" w x 67.9" h	82.0 lb	73.0 cm x 60.3 cm x 172.4 cm	37.2 kg	1





Bus/Tote Boxes

Built for long-lasting durability.

- Commercial-grade plastic has reinforced handles, bottom, and ribs for added strength and employee safety
- Rounded corners for easy cleaning
- NSF 3-A and 2-certified
- Commercial dishwasher-safe



FG335100

NO.	COLOR	DESCRIPTION	U.S. CAPACITY	U.S. DIMENSIONS	U.S. SHIP WT/CTN	METRIC CAPACITY	METRIC DIMENSIONS	METRIC SHIP WT/CTN	CASE PACK
FG334900 ^a	GRAY	Bus/Utility Box	4.6 gal	20.0" l x 15.0" w x 5.0" h	20.6 lb	17.5 L	50.8 cm x 38.1 cm x 12.7 cm	9.3 kg	12
FG334992 ^a	WHT, GRAY	Bus/Utility Box, Bulk Pack	4.6 gal	20.0" l x 15.0" w x 5.0" h	444.1 lb	17.5 L	50.8 cm x 38.1 cm x 12.7 cm	201.4 kg	180
FG335000 ^a	BRN	Divided Bus/Utility Box	7.0 gal	21.5" l x 17.1" w x 7.0" h	20.6 lb	26.5 L	54.6 cm x 43.5 cm x 17.8 cm	9.3 kg	6
FG335100 ^a	GRAY	Undivided Bus/Utility Box	7.1 gal	21.5" l x 17.1" w x 7.0" h	17.6 lb	28.9 L	54.6 cm x 43.5 cm x 17.8 cm	8.0 kg	6
FG335192 ^a	GRAY, BRN	Undivided Bus/Utility Box, Bulk Pack	7.1 gal	21.5" l x 17.1" w x 7.0" h	335.0 lb	28.9 L	54.6 cm x 43.5 cm x 17.8 cm	152.0 kg	100
FG369000 ^b	WHT	Food/Tote Box	11.0 qt	14.4" l x 12.4" w x 5.4" h	6.7 lb	10.4 L	36.5 cm x 31.4 cm x 13.7 cm	3.0 kg	6
FG364800	GRAY	Lid for FG334900 Bus/Utility Box	N/A	22.0" l x 16.5" w x 0.8" h	18.0 lb	N/A	55.9 cm x 41.9 cm x 1.9 cm	8.2 kg	12

^aCertified to NSF Std. 2 for food contact.
^bNot NSF-certified.

Cutlery Bin

Safely stores and transports cutlery to minimize employee injuries.

- Made of durable, commercial-grade plastic
- Ribbed design and special resin finish for strength
- Ideal for storing, dispensing, and transporting silverware and condiment packets
- NSF-certified and commercial dishwasher-safe



NO.	COLOR	DESCRIPTION	U.S. DIMENSIONS	U.S. SHIP WT/CTN	METRIC DIMENSIONS	METRIC SHIP WT/CTN	CASE PACK
FG336200	GRAY	Cutlery Bin, 4 Compartments	21.3" l x 11.5" w x 3.8" h	19.1 lb	54.0 cm x 29.2 cm x 9.5 cm	8.7 kg	12

Sturdy Chair™ Youth Seats

Sturdy Chair™ Youth Seats make safety and cleanliness a priority for your youngest patrons.

- Contemporary design with Microban® technology makes it easier to clean than wood
- Microban® provides all-over protection from bacteria growth that can cause odors and staining; complies with FDA standards
- Meets ASTM F404-21, TUV, and European safety standards
- Stackable design makes for easy storage
- Fits under standard table without tray
- 3-point harness with one-hand release



DECORATIVE REFUSE

CLEANING

MATERIAL HANDLING

WASHROOM

FOODSERVICE



Convenient handle for safe, one-handed maneuvering throughout dining room.

One-piece T-bar and safety harness safely helps to secure child.

FG780508PLAT



FG780608PLAT



FG780608BLA



FG781588PLAT

NO.	COLOR	DESCRIPTION	U.S. DIMENSIONS	U.S. SHIP WT/CTN	METRIC DIMENSIONS	METRIC SHIP WT/CTN	CASE PACK
FG780508	PLAT, BLA	Sturdy Chair™ Youth Seat with Wheels	23.5" l x 23.4" w x 29.7" h	18.0 lb	59.7 cm x 59.4 cm x 75.6 cm	8.2 kg	1
FG780608	PLAT, BLA	Sturdy Chair™ Youth Seat without Wheels	23.5" l x 23.5" w x 29.8" h	18.0 lb	59.7 cm x 59.7 cm x 75.6 cm	8.2 kg	1
FG781408	PLAT, BLA	Sturdy Chair™ Youth Seat, RTA (ready to assemble), No Wheels	23.5" l x 23.5" w x 29.8" h	17.0 lb	59.7 cm x 59.7 cm x 75.6 cm	7.7 kg	1
FG781588	PLAT	Tray for FG780508, FG780608, and FG781408 Chairs	11.5" l x 18.5" w x 3.3" h	2.5 lb	29.2 cm x 47.0 cm x 8.3 cm	1.1 kg	1

MICROBAN® is a registered trademark of Microban Products Company.

©2021 Microban Products Company. All rights reserved. www.microban.com

Microban® protection does not protect user from foodborne illness and is not a substitute for normal cleaning practices.

When ordering products with **BOLD** color codes, please specify color code after the product number. Refer to the Standard Color Guide at the back of the catalog.

High Chair Regulation

A federal standard (ASTM F404-21) has been approved by Consumer Product Safety Commission to improve the safety of high chairs in the United States. This regulation went into effect on all high chairs manufactured or imported after June 19, 2019.



ALL RCP HIGH CHAIRS ARE COMPLIANT WITH ASTM STANDARDS

ALL HIGH CHAIRS MUST MEET THE CRITERIA BELOW:



ACTIVE THREE-POINT RESTRAINT
An active three-point restraint system is required.



PERMANENT T-BAR RESTRAINT
T-Bar must remain in fixed position at all times.



WARNING LABELS
Warning label must communicate hazards and be clearly visible to consumer.



HIGH CHAIR STABILITY
Must not tip over when pulled forward, backward, or sideways by specified force.



- Microban® antimicrobial protection helps prevent the growth of stain- and-odor causing bacteria
- Microban® protection is built into the chair during the manufacturing process and will not wash or wear off during the life of the chair
- Sturdy Chair™ looks newer longer with built-in Microban® antimicrobial protection

REPRESENTATIVE OF ANTIMICROBIAL EFFECT – 24-HOUR ELAPSED TIME

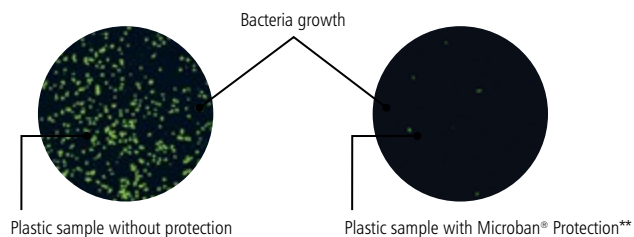

**This information is based upon standard laboratory tests and is provided for comparative purposes to substantiate antimicrobial activity for nonpublic health applications. Microban® technology is not designed to replace good building practices or protect users from disease-causing microorganisms. Antimicrobial action limited to product surfaces.





























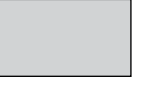
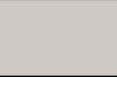









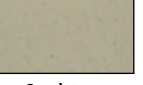

Common Metric–English Conversions

Measurement	Multiply	By	To get:
Linear	centimeters (cm) inches (in. / ") meters (m) feet (ft. /')	0.3937 2.54 3.2804 0.3048	inches centimeters feet meters
Area	centimeters ² (cm ²) inches ² (in. ²) meters ² (m ²) feet ² (ft ²)	0.155 6.4516 10.76391 0.092903	inches ² centimeters ² feet ² meters ²
Volume	centimeters ³ (cm ³) inches ³ milliliters fluid ounces liters gallons	0.06102 16.387 0.033814 29.5735 0.26417 3.78541	inches ³ centimeters ³ fluid ounces milliliters gallons liters
Mass	kilogram (kg) pounds (lbs.) grams (g) ounces (oz.)	2.2046 0.4536 0.035274 28.3495	pounds kilograms ounces grams

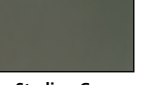
Metric Temperature Conversion To Get:

Degrees Celsius (C°)	$\frac{5 \times (\text{degrees F} - 32)}{9}$
Degrees Fahrenheit (F°)	$\frac{9 \times (\text{degrees C})}{5} + 32$

					
Aged Bronze AGBRNZ	Antique Pewter ATPWTR	Beige BEIG	Black BLA/BK00/38	Blue BLUE/BLOO	Bronze BRNZ
					
Brown BRN	Charcoal CHAR	Chrome CHRM	Clear CLR	Cobalt COBLT	Cool Gray CGRAY
					
Cylinder CYLND	Dark Blue DBLUE	Dark Green DGRN	Driftwood DWOOD	Gold GOLD	Gray GRAY/GY00/331
					
Gray Metallic Burl BGRAY	Green GRN/GR00/714	Hammered Silver HSILV	Lacquer LAC	Light Gray LGRAY	Light Platinum LPLAT
					
Mirror Stainless MSSTL	Natural NAT	Natural (Foodservice) NAT	No Color 0000	Off-White OWHT	Orange ORAN/OR00/11
					
Periwinkle PERI	Platinum PLAT/907	Red RED/RD00	Sable SBLE	Sandstone SSTON	Satin Stainless SSSTL
					
Silver SILV	Stainless Steel SSSTL/SSS/SS	Stainless Steel/Black Top SSBLA	Steel STL	Sterling Gray SGRAY	White WHT/WH00
					
White Granite WGRAN	Yellow YEL/YL00				

UTILITY AND
RECYCLING REFUSE

DECORATIVE REFUSE

CLEANING

MATERIAL HANDLING

WASHROOM

FOODSERVICE

PART NO.	DESCRIPTION	PAGE
400845	AutoFoam Dispenser Key	190
400845	TCell™ Dispenser Key	202
400845	AutoClean® Dispenser Key	208
490071	OneShot® A/C Adapter	188
490071	OneShot® A/C Adapter	189
490099	OneShot® 6V Adapter (bayonet)	188
490099	OneShot® 6V Adapter (bayonet)	189
490100	OneShot® Adapter Wire (bayonet)	188
490100	OneShot® Adapter Wire (bayonet)	189
1779636	Lid for 44-Gallon BRUTE® Container	15
1779699	BRUTE® Container without Lid	12
1779731	Lid for 20-Gallon BRUTE® Container	15
1779732	BRUTE® Container without Lid	12
1779733	Lid for 55-Gallon BRUTE® Container	15
1779734	Executive BRUTE® Container without Lid	12
1779738	Executive Lid for 55-Gallon BRUTE® Container	15
1779739	BRUTE® Container without Lid	12
1779740	BRUTE® Container without Lid	12
1779741	BRUTE® Container without Lid	12
1788372	Slim Jim® Mixed Recycling Lid for Slim Jim® Containers	21
1788373	Slim Jim® Mixed Recycling Lid for Slim Jim® Containers	21
1788376	BRUTE® 32G Lid - Bottles/Cans	15
1788472	BRUTE® Recycling Container without Lid	12
1792372	Four-Stream Glutton® Recycling Station	37
1793535	Microburst® 9000 LCD Dispenser — White	200
1820577	12" x 12" Microfiber Light Commercial Cloth	87
1820578	12" x 12" Microfiber Light Commercial Cloth	87
1820579	12" x 12" Microfiber Light Commercial Cloth	87
1820580	12" x 12" Microfiber Light Commercial Cloth	87
1820581	16" x 16" Microfiber Light Commercial Cloth	87
1820582	16" x 16" Microfiber Light Commercial Cloth	87
1820583	16" x 16" Microfiber Light Commercial Cloth	87
1820584	16" x 16" Microfiber Light Commercial Cloth	87
1829397	BRUTE® Dome Top for 32-Gallon BRUTE® Container	15
1829398	BRUTE® Dome Top for 32-Gallon BRUTE® Container	15
1829400	Slim Jim® Swing Lid for Slim Jim® Containers	21
1829411	Standard Rollout Container	17
1834840	BRUTE® Dome Top for 44-Gallon BRUTE® Container	15
1835528	HYGEN™ PULSE™ Mopping Kit with Single-Sided Frame	83
1857374	5-Quart Pail — Yellow	136
1857375	5-Quart Pail — Red	136
1857376	5-Quart Pail — Blue	136
1857377	5-Quart Pail — Green	136
1857378	Executive 5-Quart Heavy-Duty Pail — Black	136
1861427	Executive Janitorial Cleaning Cart — High-Security	134
1861430	Executive Janitorial Cleaning Cart — Traditional	135
1861443	Executive Janitorial Cleaning Cart Locking Door Kit — Traditional	135
1861443	Executive Janitorial Cleaning Cart Locking Door Kit — Traditional	137
1863884	Executive HYGEN™ Pulse™ Microfiber Spray Mop, Single Sided Flat Mop	83
1863893	Executive 17" (43.2 cm) HYGEN™ Quick-Connect Wet/Dry Frame	80
1863895	Executive HYGEN™ 18" Microfiber Wet Pad	79
1863896	Executive 35 qt WaveBrake® Side-Press Bucket and Wringer	93
1863898	Executive 35 qt WaveBrake® Down-Press Bucket and Wringer	93
1867505	Executive Multilingual Caution Sign, 2-Sided, Black	144
1867531	Executive BRUTE® Container without Lid	12
1867531	Executive BRUTE® 32-Gallon Container	137
1867532	Executive Lid for 32-Gallon BRUTE® Container	15
1867533	Executive BRUTE® Caddy Bag for 32- and 44-Gallon BRUTE® Containers	14
1867537	Executive Cube Truck w/ Quiet Casters	162
1867538	Executive Cube Truck w/ Quiet Casters	162
1880994	Executive Divided Carry Caddy	131

PART NO.	DESCRIPTION	PAGE
1880994	Executive Divided Carry Caddy	141
1881749	Collapsible X-Cart, 4 Bushels	163
1881750	Collapsible X-Cart, 8 Bushels	163
1881781	Collapsible Multi-Stream X-Cart (2 x 4 Bushels)	163
1881782	Collapsible X-Cart Replacement Bag, 4 Bushels	163
1881783	Collapsible X-Cart Replacement Bag, 8 Bushels	163
1883455	Resin Front Step	31
1883456	Resin Front Step	31
1883458	Resin Front Step	31
1883459	Resin End Step	31
1883460	Resin Front Step	31
1883551	Resin End Step	31
1883552	Resin Front Step	31
1883553	Resin End Step	31
1883554	Resin Front Step	31
1883555	Resin Front Step	31
1883557	Resin Front Step	31
1883559	Resin Front Step	31
1883561	Resin Front Step	31
1883563	Resin Front Step	31
1883564	Resin Front Step	31
1883566	Resin Front Step	31
1883568	Resin Front Step	31
1883570	Resin Front Step	31
1883575	Resin Front Step	31
1883579	Resin Front Step	31
1883600	Resin Front Step	31
1883602	Resin Front Step	31
1883604	Resin Front Step	31
1883606	Resin Front Step	31
1883609	Resin Front Step	31
1883611	Resin Front Step	31
1883613	Resin Front Step	31
1883615	Resin Front Step	31
1889863	Collapsible X-Cart Cover, Small (for 1881749)	163
1889864	Collapsible X-Cart Cover, Large (for 1881750 and 1881781)	163
1892265	AutoFoam Drip Tray	190
1901982	Stainless Steel Front Step	53
1901985	Stainless Steel Front Step	53
1901992	Stainless Steel Front Step	53
1901993	Stainless Steel End Step	53
1901999	Stainless Steel Front Step	53
1902465	Executive Quick Cart — Large	133
1902466	Executive Quick Cart — Medium	133
1902467	Executive Quick Cart — Small	133
1902468	Executive Quick Cart Caddy — Large	133
1902468	Executive Quick Cart Caddy — Large	133
1902701	Executive Quick Cart Liner — Large	133
1902702	Executive Quick Cart Liner — Medium	133
1919270	Executive Quick Cart Plastic Pocket Liner	133
1919270	Executive Quick Cart Plastic Pocket Liner	133
1919270	Executive Quick Cart Plastic Pocket Liner	133
1924815	Maximizer™ Microfiber Mop	102
1924817	Maximizer™ Microfiber Mop	102
1926827	BRUTE® Container without Lid	12
1938171	OneShot® Foam Dispenser Low Profile — Polished Chrome	188
1955959	Slim Jim® Container with Venting Channels	20
1955960	Slim Jim® Container with Venting Channels	20
1956181	Slim Jim® Container with Venting Channels	20
1956185	Slim Jim® Container with Venting Channels	20
1956186	Slim Jim® Container with Venting Channels	20
1956187	Slim Jim® Container with Venting Channels	20

PART NO.	DESCRIPTION	PAGE
1956188	Slim Jim® Container with Venting Channels	20
1956189	Slim Jim® Container with Venting Channels	20
1956191	Slim Jim® Stainless Steel Dolly for Slim Jim® Containers – Double	21
1961505	33G with Cans Label	42
1961506	33G with Compost Label	42
1961507	45G with Landfill Label	42
1961508	45G with Mixed Label	42
1961509	45G with Paper Label	42
1961572	15G with Landfill Label	43
1961573	23G with Landfill Label	43
1961574	33G with Landfill Label	43
1961575	45G with Landfill Label	43
1961580	15G with Compost Label	43
1961581	23G with Compost Label	43
1961582	33G with Compost Label	43
1961583	45G with Compost Label	43
1961588	15G with Mixed Recycling Label	43
1961589	15G with Paper Label	43
1961590	23G with Mixed Recycling Label	43
1961591	23G with Paper Label	43
1961592	33G with Mixed Recycling Label	43
1961593	33G with Paper Label	43
1961594	45G with Mixed Recycling Label	43
1961595	45G with Paper Label	43
1961596	15G with Cans Label	43
1961597	23G with Cans Label	43
1961598	33G with Cans Label	43
1961599	45G with Cans Label	43
1961614	15G with Landfill Label	42
1961615	15G with Mixed Label	42
1961616	15G with Paper Label	42
1961619	15G with Cans Label	42
1961620	15G with Compost Label	42
1961621	23G with Landfill Label	42
1961623	23G with Paper Label	42
1961626	23G with Cans Label	42
1961627	23G with Compost Label	42
1961628	33G with Landfill Label	42
1961629	33G with Mixed Label	42
1961630	33G with Paper Label	42
1961682	45G with Cans Label	42
1961683	45G with Compost Label	42
1966719	24-Gal. Janitorial Cleaning Cart Vinyl Bag – Traditional	135
1966719	24-Gal. Janitorial Cleaning Cart Vinyl Bag	136
1966720	Executive 24-Gal. Janitorial Cleaning Cart Vinyl Bag – Traditional	135
1966720	24-Gal. Janitorial Cleaning Cart Vinyl Bag	136
1966881	34-Gal. Janitorial Cleaning Cart Vinyl Bag – High-Capacity	136
1966882	34-Gal. Janitorial Cleaning Cart Vinyl Bag – High-Capacity	136
1966883	34-Gal. Janitorial Cleaning Cart Vinyl Bag – High-Capacity	136
1966885	34-Gal. Janitorial Cleaning Cart Vinyl Bag – High-Capacity	136
1966886	Executive 34-Gal. Janitorial Cleaning Cart Vinyl Bag – High-Capacity	130
1966886	Executive 34-Gal. Janitorial Cleaning Cart Vinyl Bag – High-Capacity	136
1966887	30-Gal. Housekeeping Cart Canvas Bag – High-Capacity	130
1966887	30-Gal. Housekeeping Cart Canvas Vinyl-Lined Bag	136
1966888	Executive 30-Gal. Housekeeping Cart Canvas Vinyl-Lined Bag – High Capacity	130
1966888	Executive 30-Gal. Housekeeping Cart Canvas Vinyl-Lined Bag – High-Capacity	136
1966889	Executive Side-Load Mesh Linen Bag	130
1968468	Slim Jim® Stainless Steel Dolly for Slim Jim® Containers – Single	21
1969596	Executive Full-Size Housekeeping Cart – Traditional*	128

PART NO.	DESCRIPTION	PAGE
1971257	Slim Jim® Container with Venting Channels	20
1971258	Slim Jim® Container with Venting Channels	20
1971259	Slim Jim® Container with Venting Channels	20
1971941	Standard Rollout Container	17
1971943	Standard Rollout Container	17
1971944	Step-On Rollout Container	17
1971956	Step-On Rollout Container	17
1971968	Step-On Rollout Container	17
1977787	Recycling Station Label Kit Version C fits 32 and 44 Gal BRUTE® Containers, and the Slim Jim Recycling Station	39
1980602	Slim Jim® Resin Trainable Dolly for Slim Jim® Containers	21
1980826	AutoFoam Dispenser with LumeCel™ Technology – Black/Chrome	190
1980828	AutoFoam Dispenser with LumeCel™ Technology – White/Grey Pearl	190
1980829	AutoFoam Dispenser with LumeCel™ Technology – Black/Black Pearl	190
1982724	Safty-Grip® Bath Mat - Medium	211
1982726	Safty-Grip® Bath Mat - Large	211
1982729	Safty-Grip® Bath Mat - X-Large	211
1995833	Executive Janitorial Cleaning Cart Locking Door Kit – High-Capacity	137
1997206	Small Heavy-Duty Adaptable Cart	154
1997208	Medium Heavy-Duty Adaptable Cart	154
1997371	5" Replacement Caster Set (Locking)	154
2007192	Closed Lid Insert	29
2007194	Paper Slot Lid Insert	29
2007881	Bottles/Cans Lid Insert	29
2007882	Paper Slot Lid Insert	29
2007883	Mixed Recycling Lid Insert	29
2007884	Closed Lid Insert	29
2007885	Bottles/Cans Lid Insert	29
2007886	Paper Slot Lid Insert	29
2007887	Mixed Recycling Lid Insert	29
2007888	Closed Lid Insert	29
2007889	Bottles/Cans Lid Insert	29
2007890	Paper Slot Lid Insert	29
2007891	Mixed Recycling Lid Insert	29
2007892	Closed Lid Insert	29
2007893	Bottles/Cans Lid Insert	29
2007894	Paper Slot Lid Insert	29
2007895	Mixed Recycling Lid Insert	29
2007897	Bottles/Cans Lid Insert	29
2007899	Mixed Recycling Lid Insert	29
2007900	Closed Lid Insert	29
2007903	Paper Slot Lid Insert	29
2007913	23G Starter Kit	28
2007914	2-Stream Station Landfill/Mixed Recycling	28
2007917	3-Stream Station Landfill/Paper/Bottles/Cans	28
2007918	3-Stream Station Landfill/Mixed Recycling/Compost	28
2007919	4-Stream Station Landfill/Paper/Plastic/Cans	28
2018581	Antibacterial Lotion Hand Soap	189
2018582	Antibacterial Lotion Hand Soap	189
2018595	Antibacterial Foam Hand Soap — E2	191
2018727	Maximizer™ Push-To-Center Broom – 18" MP	120
2018728	Maximizer™ Push-To-Center Broom – 36" MP	120
2018781	Maximizer™ Heavy-Duty Stand Up Debris Pan	125
2018806	Maximizer™ Wet/Dry Debris Pan	125
2025506	Disposable Wet Mop	107
2025507	Disposable Wet Mop	107
2026695	Slim Jim® Under-Counter Container	22
2026721	Slim Jim® Under-Counter Container	22
2031764	35 qt WaveBrake® Side-Press Bucket and Wringer with Drain	93
2032953	Slim Jim® Cleaning Cart Kit	23
2040044	36" Medium Polypropylene Assembled	120

UTILITY AND
RECYCLING REFUSE

DECORATIVE REFUSE

CLEANING

MATERIAL HANDLING

WASHROOM

FOODSERVICE

ACCESSORIES
& INDEX



234 Product Index

UTILITY AND
RECYCLING REFUSE

PART NO.	DESCRIPTION	PAGE
2040049	36" Fine Polypropylene	119
2044039	BRUTE® Dome Top for 44-Gallon BRUTE® Container	15
2044040	BRUTE® Dome Top for 55-Gallon BRUTE® Container	15
2044152	BRUTE® Dome Top for 32-Gallon BRUTE® Container	15
2064907	WaveBrake® Dirty Water Bucket for 35 qt or 44 qt	95
2064914	35 qt WaveBrake® Bucket and Casters	94
2064915	WaveBrake® Side-Press Wringer	95
2064959	WaveBrake® Down-Press Wringer	95
2064960	Executive WaveBrake® Side-Press Wringer	95
2064994	Executive WaveBrake® Down-Press Wringer	95
2067692	Bumper Kit for Full Size Housekeeping Carts	129
2078967	SUSTAIN LANDFILL	45
2078980	SUSTAIN MIXED RECYCLE	45
2078988	SUSTAIN LANDFILL	45
2078991	SUSTAIN COMPOST	45
2078992	SUSTAIN COMPOST	45
2078994	SUSTAIN MIXED RECYCLE	45
2080803	Alcohol Foam Hand Sanitizer	193
2089820	12G Legacy Step-On	32
2089821	23G Legacy Step-On	32
2089825	8G Legacy Step-On	32
2089826	BRUTE Recycling Tilt Truck, Standard-Duty (RM)	157
2095206	Microburst® 3000 Dispenser with LumeCel™ Technology — Black	198
2095207	Microburst® 3000 Dispenser with LumeCel™ Technology — White	198
2107627	15G with No Label	43
2107655	33G with No Label	43
2107662	45G with No Label	43
2107663	23G with No Label	43
2119307	BRUTE® Container without Lid	12
2119308	BRUTE® Container without Lid	12
2128657	BRUTE Ergo Handle Lipped-Shelf Utility Cart (Large)	165
2131929	Wheeled BRUTE® 44-Gallon Container	13
2132423	Adaptable Flat Mop Microfiber 18" Pad	86
2132425	Adaptable Flat Mop Wringer Insert Designed for WaveBrake®	86
2132426	Adaptable Flat Mop Kit* Designed for WaveBrake®	86
2132427	Adaptable Flat Mop Microfiber 18" Pad	86
2132428	Adaptable Flat Mop 18" Frame Designed for WaveBrake®	86
2132431	Adaptable Flat Mop Microfiber 18" Pad	86
2134282	HYGEN 18" Disposable Microfiber Pad	75
2134283	HYGEN 12" X 12" Disposable Microfiber Cloth	75
2135007	HYGEN 12" X 12" Disposable Microfiber Charging Tub for Cloth	75
2136963	Elevate™ Landfill 23G	51
2143281	45G with No Label	42
2143543	AutoFoam Standard Floor Stand	195
2144269	Tote Picking Cart	177
2144291	33G with No Label	42
2146547	Replacement Clips	13
2147031	Alcohol-Free Foam Hand Sanitizer — E3	191
2147550	Refine Half Round	51
2147581	Refine Slim	51
2147582	Refine Half Round	51
2147583	Refine Round Top	51
2147584	Refine Round Top	51
2154626	Towable Pallet Cart (50" x 50")	173
2154629	Towable Platform Truck (30" x 60")	173
2166020	BRUTE® Tote with Lid	183
2171553	33G Starter Kit	28
2171554	1-Stream 33 Gallon Landfill Kit	26
2171555	1-Stream 33 Gallon Compost Kit	26
2171557	1-Stream 33 Gallon Mixed Recycling Kit	26
2172841	Round Dual Stream	47

DECORATIVE REFUSE

CLEANING

MATERIAL HANDLING

WASHROOM

FOODSERVICE

ACCESSORIES
& INDEX

PART NO.	DESCRIPTION	PAGE
2172842	Round Single Stream	47
2172843	Pill Dual Stream	47
2172844	Round Dual Stream	47
2172845	Half Round Single Stream	47
2172846	Half Round Dual Stream	47
2172847	Round Dual Stream	47
2172848	Round Dual Stream	47
2172849	Round Single Stream	47
2172850	Round Single Stream	47
2172851	Pill Single Stream	47
2172852	Round Single Stream	47
2173519	Motorized Roto Tilt Truck 0.5 CU YD	158
2173520	Motorized Kit Charger	129
2173520	Motorized Kit Charger	158
2173520	Motorized Kit Charger	172
2173556	Housekeeping Cart Motorized Kit1	129
2173661	Motorized Kit For Platform Truck Large 30" x 60" 1	172
2173662	Motorized Roto Tilt Truck 1.0 CU YD	158
2173663	Motorized Kit For Platform Truck Med 24" x 48" 1	172
2173664	Motorized Kit Universal Battery	129
2173664	Motorized Kit Universal Battery	158
2173664	Motorized Kit Universal Battery	172
2175515	Dye and Fragrance Free Hand Soap	191
2179403	Wheeled BRUTE® 32-Gallon Container	13
2182610	Medium Decorative Metal Panel	63
2182671	Medium Landfill Panel Resin Panel	63
2182672	Tailor™ 41G Metal Frame	62
2182673	Medium Compost Resin Panel	63
2182674	Large Mixed Recycling Resin Panel	63
2182675	Square Dual Stream	49
2182676	Large Decorative Metal Panel	63
2182677	Medium Mixed Recycling Resin Panel	63
2182678	Tailor™ 51G Metal Frame	62
2182679	Large Landfill Resin Panel	63
2184979	Resist® 45G Single Stream	59
2184980	Resist® 46G Dual Stream	59
2185041	Resist® 33G Single Stream	59
2185042	Resist® 66G Dual Stream	59
2185051	1-Stream 23 Gallon Compost Kit	26
2185052	1-Stream 23 Gallon Bottles/Cans Kit	26
2185053	1-Stream 23 Gallon Landfill Kit	26
2185054	1-Stream 23 Gallon Paper Kit	26
2185055	1-Stream 23 Gallon Mixed Recycling Kit	26
2186280	Maximizer™ Push-To-Center Broom – 24" MP	120
2192462	BRUTE Tilt Truck, Standard-Duty (RM)	157
2192463	BRUTE Ergo Handle Utility Cart (Large)	165
2192464	BRUTE Ergo Handle Utility Cart (Med)	165
2192465	BRUTE Tilt Truck, Heavy-Duty (RM)	157
2192467	BRUTE Tilt Truck, Heavy-Duty (RM)	157
3486108	Light Commercial Microfiber Spray Mop (mop pad not included)	87
3486575	Hair & Body Foam Soap	192
3486577	Alcohol Foam Hand Sanitizer — E3	192
50565400	Axle for FG565461	182
52564200	Axle for FG564200	182
2148939	23G with No Label	42
1782742	Milano - Polished Chrome	205
1782743	Milano - Polished Chrome	205
1782744	Milano - Polished Chrome	205
1793531	Microburst® 3000 LCD Dispenser — Black	199
1793532	Microburst® 3000 LCD Dispenser — White	199
1793533	Microburst® 3000 LCD Dispenser — Chrome	199
1793536	Microburst® 9000 LCD Dispenser — Chrome	200

PART NO.	DESCRIPTION	PAGE
1793546	TCell™ Dispenser — Black	202
1793547	TCell™ Dispenser — White	202
1793548	TCell™ Dispenser — Chrome	202
1818966	Milano - Polished Chrome	205
1818967	Milano - Polished Chrome	205
1818968	Milano - Polished Chrome	205
2080802	Alcohol Foam Hand Sanitizer — E3	191
2095208	Microburst® 3000 Dispenser with LumeCel™ Technology — Chrome	198
2144270	Tote Storage Bracket	177
2192466	BRUTE Tilt Truck, Standard-Duty (RM)	157
3486561	Moisturizing Foam Hand Soap	192
3486562	Moisturizing Lotion Hand Soap	192
3486571	Moisturizing Foam Hand Soap	192
3486572	Moisturizing Lotion Hand Soap	192
3486589	Flex™ Dispenser White — 500 mL	192
3486590	Flex™ Dispenser Black — 500 mL	192
3486591	Flex™ Dispenser White — 1000 mL, 1300 mL	192
3486592	Flex™ Dispenser Black — 1000 mL, 1300 mL	192
401096	AutoFlush® High Mount Adapter Kit	206
401165	AutoFlush® Crane Valve Adapter Kit	206
401239	AutoFlush® Teck Valve Adapter	206
401477	AutoFlush® Tempus Valve Adapter	206
401972	AutoFlush® Coyne & Delany/Crane Rex Adapter Kit	207
401973	AutoFlush® Canadian Adapter Kit (Crane, Teck, Tempus)	207
4870577	AutoFlush® Power Adapter Kit	207
FG101100	Structural Foam Tilt Truck, Utility-Duty	156
FG101300	Structural Foam Tilt Truck, Standard-Duty	156
FG102500	BRUTE Tilt Truck, Standard-Duty (RM)	157
FG102542	BRUTE Forkliftable Tilt Truck, Standard-Duty (RM)	160
FG102641	BRUTE Towable Trainable Tilt Truck, Heavy-Duty (RM)	160
FG102700	Lid for 11/2 Cubic Yard Tilt Trucks	157
FG102700	Lid for 11/2-Cubic-Yard Tilt Trucks	160
FG102800	Lid for 3/4-Cubic-Yard Tilt Trucks	156
FG103600	BRUTE Tilt Truck, Heavy-Duty (RM)	157
FG104600	BRUTE Tilt Truck, Heavy-Duty (RM)	157
FG105443	Self-Dumping Hopper with four 6" dia (15.2 cm) Polyolefin Casters	161
FG105943	Self-Dumping Hopper with four 6" dia (15.2 cm) Polyolefin Casters	161
FG130400	Tilt Truck, Utility-Duty (RM)	157
FG130500	BRUTE Tilt Truck, Standard-Duty (RM)	157
FG130573	BRUTE Recycling Tilt Truck, Standard-Duty (RM)	157
FG130600	BRUTE Tilt Truck, Heavy-Duty (RM)	157
FG130700	Lid for 1/2 Cubic Yard Tilt Trucks	157
FG130700	Lid for 1/2-Cubic-Yard Tilt Trucks	160
FG131400	Tilt Truck, Utility-Duty (RM)	157
FG131500	BRUTE Tilt Truck, Standard-Duty (RM)	157
FG131542	BRUTE Forkliftable Tilt Truck, Standard Duty (RM)	160
FG131600	BRUTE Tilt Truck, Heavy-Duty (RM)	157
FG131641	BRUTE Towable Trainable Tilt Truck, Heavy-Duty (RM)	160
FG131700	Lid for 1 Cubic Yard Tilt Trucks	157
FG131700	Lid for 1-Cubic-Yard Tilt Trucks	160
FG172000	Palletote® Lid for FG172100, FG172200	183
FG172100	Palletote — 1.3 ft3	177
FG172100	Palletote® Box	183
FG172200	Palletote® Box	183
FG173000	Palletote® Lid for FG173100	183
FG173100	Palletote — 2.0 ft3	177
FG173100	Palletote® Box	183
FG190100	Scraper	222
FG190500	Scraper	222
FG190600	Scraper	222
FG193300	Spoon-Shaped Spatula	222

PART NO.	DESCRIPTION	PAGE
FG193400	Spoon-Shaped Spatula	222
FG193800	Spoon-Shaped Spatula	222
FG196200	Color Coded High-Heat Spatula (Red)	222
FG196300	Color Coded High-Heat Spatula (Red)	222
FG196400	High-Heat Scraper	222
FG196600	High-Heat Spoon Scraper	222
FG196700	High-Heat Spoon Scraper	222
FG196800	High-Heat Spoon Scraper	222
FG199300	Closet Organizer/Tool Holder Kit	140
FG200500	Heavy-Duty Dust Pan	124
FG245506	Ironing Organizer	140
FG252300	Mobile Two-Step Stepstool	140
FG253100	Executive Lobby Pro® Dust Pan, Long Handle	121
FG253120	Lobby Pro Upright Dust Pan	121
FG253200	Executive Lobby Pro® Dust Pan with Cover, Long Handle	121
FG253600	Executive Lobby Broom w/ Wood Handle	121
FG254100	Fire-Resistant Wastebasket	36
FG254300	Fire-Resistant Wastebasket	36
FG254400	Fire-Resistant Wastebasket	36
FG256800	Glutton® Container	67
FG256V00	Glutton® Hooded Top without doors for FG256B00 Containers	67
FG257088	GroundsKeeper® Smoking Management Receptacle	68
FG260900	Lid for 10-Gallon BRUTE® Container	15
FG261000	BRUTE® Container without Lid	12
FG261400	Round Bucket	111
FG261700	Double Pail	111
FG261960	Lid for 20-Gallon BRUTE® Container	15
FG262000	BRUTE® Container without Lid	12
FG262073	BRUTE® Recycling Container without Lid	12
FG262888	Double Pail	111
FG263100	Lid for 32-Gallon BRUTE® Container	15
FG263200	BRUTE® Container without Lid	12
FG263200	BRUTE® 32-Gallon Container	137
FG263273	BRUTE® Recycling Container without Lid	12
FG263600	GreensKeeper® Container with Lid and Dolly	216
FG263788	BRUTE® Dome Top for 32-Gallon BRUTE® Container	15
FG264000	BRUTE® Dolly for 20-, 32-, 44-, and 55-Gallon BRUTE® Containers	14
FG264043	BRUTE® Quiet Dolly for 20-, 32-, and 44-Gallon BRUTE® Containers	14
FG264200	BRUTE® Caddy Bag for 32- and 44-Gallon BRUTE® Containers	14
FG264307	BRUTE® Recycling Container without Lid	12
FG264360	BRUTE® Container without Lid	12
FG264360	BRUTE® 44-Gallon Utility Container with Venting Channels	137
FG264560	Lid for 44-Gallon BRUTE® Container	15
FG264600	BRUTE® Tandem Dolly for 20-, 32-, and 44-Gallon BRUTE® Containers	14
FG264788	BRUTE® Dome Top for 44-Gallon BRUTE® Container	15
FG264900	Maid Caddy	14
FG265000	Universal Drum Dolly for BRUTE® Containers	14
FG265400	Lid for 55-Gallon BRUTE® Container	15
FG265500	BRUTE® Container without Lid	12
FG265788	BRUTE® Dome Top for 55-Gallon BRUTE® Container	15
FG267360	Slim Jim® Swing Lid for Slim Jim® Containers	21
FG267400	Executive Slim Jim® Hinged Lid for Slim Jim® Containers	21
FG268888L	Slim Jim® Handle Top	21
FG269288	Slim Jim® Bottles and Cans Recycling Lid for Slim Jim® Containers	21
FG270388	Slim Jim® Paper Recycling Lid for Slim Jim® Containers	21
FG288200	Bouncer® Bar Scoop	223
FG288400	Bouncer® Utility Scoop	223
FG288500	Utility Scoop	223
FG294700	Universal Round Container	33

UTILITY AND RECYCLING REFUSE

DECORATIVE REFUSE

CLEANING

MATERIAL HANDLING

WASHROOM

FOODSERVICE

ACCESSORIES & INDEX



PART NO.	DESCRIPTION	PAGE
FG295500	Wastebasket, Small	34
FG295573	Deskside Recycling Container, Small with Universal Recycle Symbol	34
FG295600	Wastebasket, Medium	34
FG295606	Deskside Recycling Container, Medium with Universal Recycle Symbol	34
FG295673	Deskside Recycling Container, Medium with Universal Recycle Symbol	34
FG295700	Wastebasket, Large	34
FG295773	Deskside Recycling Container, Large with Universal Recycle Symbol	34
FG296300	Round Bucket	111
FG306600	Swing Top for FG295600 Container	34
FG306700	Swing Top for FG295700 Container	34
FG315488	Deluxe Carry Caddy	141
FG321000	Bouncer® Measuring Cup	223
FG321500	Bouncer® Measuring Cup	223
FG321600	Bouncer® Measuring Cup	223
FG321700	Bouncer® Measuring Cup	223
FG321800	Bouncer® Measuring Cup	223
FG330000	Food/Tote Box	218
FG330100	Food/Tote Box	218
FG330200	Lid for FG330000, FG330100, FG330600, FG330800, FG332800 Food/Tote Boxes	218
FG330300	Food/Tote Boxes	218
FG330400	Food/Tote Box	218
FG330600	Food/Tote Box	218
FG330700	Food/Tote Box	218
FG330800	Food/Tote Box	218
FG330900	Food/Tote Box	218
FG331000	Lid for FG330400, FG330700, FG330900	218
FG332000	ProServe® Rack (18-slot end loader for food boxes and sheet pans)	225
FG332800	Food/Tote Box	218
FG334900	Bus/Utility Box	168
FG334900	Bus/Utility Box	227
FG334992	Bus/Utility Box, Bulk Pack	227
FG335000	Divided Bus/Utility Box	227
FG335100	Undivided Bus/Utility Box	227
FG335192	Undivided Bus/Utility Box, Bulk Pack	227
FG335388	Refuse Bin	168
FG335388	8 Gallon Refuse Bin	177
FG335488	Utility Bin	168
FG335488	Utility Bin	177
FG336200	Cutlery Bin, 4 Compartments	227
FG342100	Utility Cart with 3" dia (7.6 cm) Swivel Casters and End Panels	169
FG342488	Utility Cart with 4" dia (10.2 cm) Swivel Casters	169
FG345700	Utility Cart with Lockable Doors, Sliding Drawer, and 4" dia (10.2 cm) Swivel Casters	169
FG350000	Food/Tote Box	219
FG350100	Food/Tote Box	219
FG350200	Lid for FG350000, FG350100, FG350600, FG350800, FG352800 Food/Tote Boxes	219
FG350400	Food/Tote Box	219
FG350600	Food/Tote Box	219
FG350700	Food/Tote Box	219
FG350800	Food/Tote Box	219
FG350900	Food/Tote Box	219
FG351000	Lid for FG350400, FG350700, FG350900	219
FG352000	Universal Half	33
FG352600	BRUTE® Square Container without Lid	15
FG352700	Lid for FG352600 Container	15
FG352800	Food/Tote Box	219
FG352900	Snap-Lock® Lid for FG352600 Container	15
FG353000	BRUTE® Square Dolly for BRUTE® Square Containers	14
FG353000	BRUTE® Square Dolly	146

PART NO.	DESCRIPTION	PAGE
FG353600	BRUTE® Square Container without Lid	15
FG353900	Lid for FG353600 Container	15
FG354007	Slim Jim® Container with Venting Channels – Recycling	20
FG354007	Slim Jim® with Venting Channels – Recycling	137
FG354060	Slim Jim® Container with Venting Channels	20
FG354060	Slim Jim® with Venting Channels	137
FG354300	Funnel Top for 32-Gallon BRUTE® Containers	15
FG354600	Round Container	33
FG355000	Rigid Liner for FG816088 Container	56
FG355200	Rigid Liner with Rim for FG817088 Container	56
FG356300	Rigid Liner for FG999000 Container	66
FG356600	Rigid Liner for FG843088	65
FG356973	Universal Square Container (liner for FG917500/FG917600)	33
FG356988	Universal Round Container	33
FG360088	Slant-Front Ingredient Bin with Sliding Lid and 32-oz (0.9-L) Scoop	214
FG360288	Slant-Front Ingredient Bin with Sliding Lid and 32-oz (0.9-L) Scoop	214
FG360388	Slant-Front Ingredient Bin with Sliding Lid and 32-oz (0.9-L) Scoop	214
FG364800	Lid for FG334900 Bus/Utility Box	227
FG369000	Food/Tote Box	227
FG395800	Universal Square Container	33
FG395800	Universal Square Container (liner for FG917188/FG917388)	65
FG395800	Universal Square Container (liner for FG396400)	66
FG395873	Universal Square Container	33
FG395900	Universal Square Container (liner for FG917100/FG917300/FG396500)	33
FG395973	Universal Square Recycling Container	33
FG396400	Plaza® Container	66
FG397000	Landmark Series® Classic Container, Dome Top Frame with FG395800 Rigid Liner	62
FG397001	Landmark Series® Classic Container, Dome Top with Ash Tray, Frame and FG395800 Rigid Liner	62
FG397500	Landmark Series® Classic Container, Dome Top Frame with FG395900 Rigid Liner	62
FG397501	Landmark Series® Classic Container, Dome Top with Ash Tray, Frame and FG395900 Rigid Liner	62
FG400300	Medium Rock Panel	63
FG400400	Large Rock Panel	63
FG400586	Purinel® SC — Drain Maintainer & Cleaner	208
FG401187A	AutoFlush® Sidemount for Sloan or Zurn Valves - Polished Chrome	206
FG401206A	AutoFlush® Sidemount for Coyne & Delany Flushboy Valves - Polished Chrome	206
FG4012441	Microburst® 9000 Refill — Linen Fresh™	200
FG4012451	Microburst® 9000 Refill — Orchard Fields	200
FG4012461	Microburst® 9000 Refill — Mountain Peaks	200
FG4012471	Microburst® 9000 Refill — Ocean Breeze	200
FG4012551	Microburst® 3000 Refill — Linen Fresh™	198
FG4012551	Microburst® 3000 Refill — Linen Fresh™	199
FG4012561	Microburst® 3000 Refill — Orchard Fields	198
FG4012561	Microburst® 3000 Refill — Orchard Fields	199
FG4012571	Microburst® 3000 Refill — Mountain Peaks	198
FG4012571	Microburst® 3000 Refill — Mountain Peaks	199
FG4012581	Microburst® 3000 Refill — Ocean Breeze	198
FG4012581	Microburst® 3000 Refill — Ocean Breeze	199
FG4012591	Microburst® 3000 Refill — Country Delight™	198
FG4012591	Microburst® 3000 Refill — Country Delight™	199
FG401310	OneShot® Liquid Dispenser — Polished Chrome/Black	189
FG4013111	Moisturizing Lotion Hand Soap	189
FG4013131	Green Seal Certified Lotion Hand Soap	189
FG401532	AutoClean® Cleaner & Deodorizer Refill — Mandarin Orange	208
FG4015411	Moisturizing Lotion Hand Soap	189
FG4015431	Green Seal Certified Lotion Hand Soap	189
FG401690	Microburst® 3000 Refill — Mango	198
FG401690	Microburst® 3000 Refill — Mango	199
FG401693	Microburst® 9000 Refill — Mango	200

PART NO.	DESCRIPTION	PAGE
FG401805	AutoFlush® Clamp - Polished Chrome	207
FG402093	Microburst® 9000 Refill — Mandarin Orange	200
FG402112	TCell™ Refill — Blue Splash	202
FG402113	TCell™ Refill — Citrus	202
FG402241	OneShot® Liquid Dispenser Low Profile — Polished Chrome	189
FG402243	OneShot® Liquid Dispenser Low Profile Metal — Polished Chrome	189
FG402310	Clean Seat Foam 400 mL Dispenser — White	209
FG402312	Clean Seat Foam Refill	209
FG402363	Dye & Fragrance Free Lotion Hand Soap	189
FG402364	Dye & Fragrance Free Lotion Hand Soap	189
FG402369	TCell™ Refill — Mango Blossom	202
FG402408	Microburst® 3000 Refill — Mandarin Orange	198
FG402408	Microburst® 3000 Refill — Mandarin Orange	199
FG402470	TCell™ Refill — Cucumber Melon	202
FG402498	TCell™ Refill — Pure™ Odor Neutralizer	202
FG402537	Clean Seat Spray Refill	209
FG409100	Utility Cart, Open-Sided	169
FG409300	Utility Cart with Enclosed End Panels on 3 Sides	169
FG409400	Instrument Cart with Lockable Doors and Sliding Drawers	169
FG409500	Equipment Cart	169
FG409600	4-Shelf Cart, Open-Sided	169
FG421288	Executive Single-Action Basic Mechanical Sweeper	139
FG421388	Executive Dual-Action Bristle Mechanical Sweeper	139
FG421588	Executive Dual-Action Brushless Mechanical Sweeper	139
FG424288	100 U.S. Gallon Stock Tank	181
FG424300	50 U.S. Gallon Stock Tank	181
FG424500	150 U.S. Gallon Stock Tank	181
FG424700	300 U.S. Gallon Stock Tank	181
FG424806	Stock Tank Float Valve	181
FG425100	Over-the-Spill® Station Kit includes Pad Dispenser, 22 Large Pads, and Fasteners	147
FG425200	Over-the-Spill® Station Pads, Large; Refill Pads for FG425100, Contains 22 Pads	147
FG425300	Over-the-Spill® Station Pads, Medium; Refill Pads for FG425100, Contains 22 Pads	147
FG425400	Over-the-Spill® Pad Tablet, Contains 22 Pads	147
FG430000	Convertible Utility Cart	167
FG440000	Triple® Trolley, Utility-Duty with Straight Handle and 3" (7.6 cm) Casters	171
FG440100	Triple® Trolley, Standard Duty with User-Friendly Handle and 5" dia x .875" w (12.7 cm x 2.22 cm) Casters	171
FG440300	Heavy-Duty Platform Truck	171
FG440600	Heavy-Duty Platform Truck	171
FG443600	Heavy-Duty Platform Truck (Med 24" x 48")*	171
FG443610	Heavy-Duty Platform Truck*	171
FG444100	Heavy-Duty Platform Truck*	171
FG446600	Heavy-Duty Platform Truck*	171
FG446800	Sheet and Panel Truck (24" x 48")	174
FG447100	Heavy-Duty Platform Truck*	171
FG448600	Side-Panel Platform Truck (24" x 48")	175
FG450017	Manual Foam Dispenser — White	193
FG450019	Moisturizing Foam Hand Soap	193
FG450034	Manual Foam Dispenser — Black	193
FG450088	BRUTE Ergo Handle Utility Cart (Small)	165
FG450089	Flat Handle Utility Cart (Small)	165
FG450500	Ergo Handle Utility Cart (Small)	165
FG450589	Flat Handle Utility Cart (Small)	165
FG451388	TradeMaster® Cart with 4 Drawers	167
FG452010	BRUTE Ergo Handle Utility Cart (Med) with Pneumatic Casters	165
FG452088	BRUTE Ergo Handle Utility Cart (Med)	165
FG452089	Flat Handle Utility Cart (Med)	165
FG452500	Ergo Handle Utility Cart (Med)	165
FG452589	Flat Handle Utility Cart (Med)	165
FG453388	TradeMaster® Cart with 4 Drawers and Cabinet, Small	167

PART NO.	DESCRIPTION	PAGE
FG454500	Ergo Handle Utility Cart (Large)	165
FG454600	BRUTE Ergo Handle Utility Cart (Large)	165
FG454610	BRUTE Ergo Handle Utility Cart (Large) with Pneumatic Casters	165
FG459200	8" Replacement Caster Set	154
FG459300	Extension Drawer	154
FG460800	Cube Truck	162
FG460800D	Cube Truck	162
FG460900	Lid for 8 ft.3 Cube Trucks	162
FG461100	Spring Platform Truck	162
FG461200	Cube Truck	162
FG461300	Lid for 12 ft.3 Cube Trucks	162
FG461400	Cube Truck	162
FG461500	Lid for 16 ft.3 Cube Trucks	162
FG461500	Lid for 14 ft.3 Cube Trucks	162
FG461600	Cube Truck	162
FG461600D	Cube Truck	162
FG461673	Recycling Cube Truck	162
FG461700	Lid for 20 ft.3 Cube Trucks	162
FG461900	Cube Truck	162
FG470800	Utility Truck, Heavy-Duty with 4" dia (10.2 cm) Casters	162
FG471200	Utility Truck, Heavy-Duty with 4" dia (10.2 cm) Casters	162
FG471600	Utility Truck, Heavy-Duty with 5" dia (12.7 cm) Casters	162
FG472000	Utility Truck, Heavy-Duty with 5" dia (12.7 cm) Casters	162
FG472600	Lid for 27 ft.3 Cube Trucks	162
FG472700	Utility Truck, Heavy-Duty with 5" dia (12.7 cm) Corner Casters	162
FG4870465	OneShot® Foam Dispenser Low Profile Metal — Polished Chrome	188
FG500409	AutoClean® LED Dispenser — Chrome (Kit w/ 3/4" Connector)	208
FG500410	AutoClean® LED Dispenser — Chrome (Kit w/ 1/2" Connector)	208
FG500888	Can Liners	39
FG501188	Can Liners	39
FG505012	Stock Tank Drain Plug Kit	181
FG564200	8.75-Cu.-Ft. Big Wheel Cart	182
FG571473	14-Gallon Recycling Box	37
FG571873	18-Gallon Recycling Box	37
FG572000	Round Storage Container	221
FG572024	Round Storage Container	221
FG572100	Round Storage Container	221
FG572124	Round Storage Container	221
FG572200	Color-Coded Round Container Lid	221
FG572300	Round Storage Container	221
FG572324	Round Storage Container	221
FG572400	Round Storage Container	221
FG572424	Round Storage Container	221
FG572500	Color-Coded Round Container Lid	221
FG572600	Round Storage Container	221
FG572624	Round Storage Container	221
FG572700	Round Storage Container	221
FG572724	Round Storage Container	221
FG572800	Round Storage Container	221
FG572824	Round Storage Container	221
FG572900	Round Storage Container with Bail	221
FG573000	Color-Coded Round Container Lid	221
FG611200	Floor Sign with Multilingual "Caution" Imprint, 2-Sided	144
FG611277	Floor Sign with "Caution Wet Floor" Imprint, 2-Sided	144
FG611278	Floor Sign with Multilingual "Closed" Imprint, 2-Sided	144
FG611477	Floor Sign with "Caution Wet Floor" Imprint, 4-Sided	144
FG614300	8G Legacy Step-On	32
FG614400	12G Legacy Step-On	32
FG614500	18G Legacy Step-On	32
FG614600	23G Legacy Mobile Step-On	32
FG617388	Janitorial Cleaning Cart – Traditional	135
FG617900	Executive Cart Waste/Bag Lid with Storage – High-Capacity	137

UTILITY AND
RECYCLING REFUSE

DECORATIVE REFUSE

CLEANING

MATERIAL HANDLING

WASHROOM

FOODSERVICE

ACCESSORIES
& INDEX



PART NO.	DESCRIPTION	PAGE
FG618000	Trades Cart with 5" (12.7 cm) Casters includes 2 parts boxes and 4 parts bins	166
FG618088	Trades Cart with Locking Cabinet includes 2 parts boxes and 4 parts bins	166
FG618100	Janitorial Cleaning Cart Locking Door Kit - Traditional	135
FG618100	Janitorial Cleaning Cart Locking Door Kit – Traditional	137
FG618688	44 qt WaveBrake® Side-Press Bucket and Wringer with Drain	93
FG618900	Executive Full-Size Housekeeping Cart – Traditional*	128
FG619000	Executive Compact Housekeeping Cart – Traditional*	128
FG619100	Executive Full-Size Housekeeping Cart with Doors – Traditional*	128
FG619200	Executive Compact Housekeeping Cart with Doors – Traditional* 1	128
FG619400	Pail and Mop Strainer Combination	111
FG619500	Executive Adjustable Shelf Kit for Traditional Housekeeping Carts	131
FG619700	Executive Locking Door Kit for Traditional Housekeeping Carts	131
FG627600	Safety Cone 36" (91.4 cm) with Multilingual "Caution" Imprint	146
FG627677	Safety Cone 36" (91.4 cm) with Multilingual "Caution Wet Floor" Imprint	146
FG627777	Safety Cone 25.8" (65.4 cm) with Multilingual "Caution Wet Floor" Imprint	146
FG628400	Weight Ring	68
FG630000	Premium Linen Hamper	163
FG630200	Space-Saving Square Container	220
FG630400	Space-Saving Square Container	220
FG630600	Space-Saving Square Container	220
FG630800	Space-Saving Square Container	220
FG631000	Toilet Bowl Brush, Plastic Handle, Polypropylene Fill	123
FG631100	Toilet Bowl Brush Holder, fits FG631000 Brush	123
FG631200	Space-Saving Square Container	220
FG631800	Space-Saving Square Container	220
FG632000	Toilet Bowl Brush, Plastic Handle, Polypropylene Fill	123
FG632200	Space-Saving Square Container	220
FG633700	Floor Scrub, Plastic Block, Bi-level, Polypropylene Fill	123
FG634200	Plastic Block Counter Brush, Flagged Polypropylene Fill with 8" (20.3 cm) Bristle Coverage	124
FG635000	Premium Linen Hamper Bag	163
FG635700	Super Self-Locking Wood Handle, Threaded Metal Tip	120
FG636100	Wood Handle, Threaded, Lacquered	120
FG636200	Wood Handle, Tapered, Sanded	120
FG636400	Wood Handle, Threaded Metal Tip, Lacquered	120
FG637300	Lobby Broom, 100% Corn Fill	121
FG637400	Executive Lobby Broom w/ Vinyl Handle	121
FG637500	Broom, 1" dia (2.5 cm) Vinyl-Coated Metal Handle, Flagged Polypropylene Fill	121
FG638300	Corn Broom, Warehouse, 1.13" dia (2.9 cm) Stained/Lacquered Handle	121
FG638500	Broom, 1" dia (2.5 cm) Metal Handle, Flagged Polypropylene Fill	121
FG638906	Jumbo Smooth Sweep Angle Broom, 17/8" dia (4.76 cm) Black Metal Handle, Polypropylene Fill	121
FG643500	Steel Sponge Mop with Cellulose Head	111
FG643600	Steel Cellulose Replacement Head	111
FG648200	Iron Handle Scrub Brush, Polypropylene Fill	123
FG650900	Color-Coded Square Container Lid	220
FG652300	Color-Coded Square Container Lid	220
FG738000	Tandem™ 31-Qt Bucket and Wringer Combo	95
FG748000	26 qt WaveBrake® Side-Press Bucket and Wringer	93
FG750112	Moisturizing Foam Hand Soap	191
FG750127	AutoFoam Dispenser — Black/Black Pearl	190
FG750363	Microburst® 3000 Refill — Cucumber Melon	198
FG750363	Microburst® 3000 Refill — Cucumber Melon	199
FG750386	Moisturizing Foam Hand Soap	188
FG750389	Dye & Fragrance Free Foam Hand Soap — E1‡	188
FG750390	Dye & Fragrance Free Foam Hand Soap — E1‡	188
FG750411	AutoFoam Dispenser — Black/Chrome	190
FG750517	Moisturizing Foam Hand Soap	188
FG750824	AutoFoam Premium Floor Stand	195

PART NO.	DESCRIPTION	PAGE
FG757688	44 qt WaveBrake® Down-Press Bucket and Wringer with Drain	93
FG757788	35 qt WaveBrake® Down-Press Bucket and Wringer	93
FG757788	35 qt WaveBrake® Down-Press Bucket and Wringer	93
FG757888	35 qt WaveBrake® Down-Press Bucket and Wringer	93
FG757888	35 qt WaveBrake® Down-Press Bucket and Wringer	93
FG758088	35 qt WaveBrake® Side-Press Bucket and Wringer	93
FG758088	35 qt WaveBrake® Side-Press Bucket and Wringer	93
FG758888	35 qt WaveBrake® Side-Press Bucket and Wringer	93
FG758888	35 qt WaveBrake® Side-Press Bucket and Wringer	93
FG758888	35 qt WaveBrake® Side-Press Bucket and Wringer	93
FG759088	35 qt WaveBrake® Institutional Bucket and Sieve Wringer	94
FG773488	5-Drawer Mobile Work Center	166
FG780508	Sturdy Chair™ Youth Seat with Wheels	228
FG780608	Sturdy Chair™ Youth Seat without Wheels	228
FG781408	Sturdy Chair™ Youth Seat, RTA (ready to assemble), No Wheels	228
FG781588	Tray for FG780508, FG780608, and FG781408 Chairs	228
FG781788	Protective Liners for Baby Changing Stations Laminated 2-ply Tissue Paper	210
FG781888	Baby Changing Station - Horizontal	210
FG781988	Baby Changing Station - Vertical	210
FG782200	Slim Jim® Wall-Mounted Container	36
FG816088	Marshal® Classic Container	56
FG817088	Marshal® Classic Container	56
FG843088	35-Gallon Ranger® Container with 2 Doors	65
FG917188	45-Gallon Ranger® Container with 2 Doors	65
FG917388	45-Gallon Ranger® Container with 4 Openings	65
FG917700	Weighted Base Accessory for 45-Gallon Ranger® Containers	65
FG9B2900	Short Plastic-Handle Utility Brush, Synthetic Fill	122
FG9B5500	Corn Whisk Broom	124
FG9B5600	Tile and Grout Brush, Polypropylene Bristles	123
FG9C0306	Executive Spray Bottle, 32-oz.	141
FG9C0400	30"-42" (76.2 cm–106.6 cm) Lambswool Duster with Telescoping Plastic Handle	117
FG9C2700	22" (55.9 cm) Standard Floor Squeegee	125
FG9C2800	22" (55.9 cm) Heavy-Duty Floor Squeegee	125
FG9C2900	30" (76.2 cm) Heavy-Duty Floor Squeegee	125
FG9C3200	24" (61 cm) Straight Floor Squeegee	125
FG9C3400	24" (61 cm) Curved Floor Squeegee	125
FG9F7500	Bouncer® Contour Scoop for FG360088, FG360288, FG360388 Ingredient Bins and FG9F Prosave Sliding Lids	215
FG9F7500	Bouncer® Contour Scoop for FG360088, FG360288, FG360388 Ingredient Bins (32-oz scoop)	223
FG9F7600	Bouncer® Contour Scoop for FG360088, FG360288, FG360388 Ingredient Bins and FG9F Prosave Sliding Lids	215
FG9F7600	Bouncer® Contour Scoop for FG360088, FG360288, FG360388 Ingredient Bins (64-oz scoop)	223
FG9F7700	Sliding Lid with 32-oz (0.9-L) Scoop for FG360088 Ingredient Bin	214
FG9F7800	Sliding Lid with 32-oz (0.9-L) Scoop for FG360288 Ingredient Bin	214
FG9F7900	Sliding Lid with 32-oz (0.9-L) Scoop for FG360388 Ingredient Bin	214
FG9G5700	100-Cup Shelf Ingredient Bin with 2-Cup Scoop	214
FG9G5800	200-Cup Shelf Ingredient Bin with 2-Cup Scoop	214
FG9G6000	40-Cup Shelf Ingredient Bin with ½-Cup Scoop	214
FG9G7600	Rotating Lid with 2-Cup Scoop (fits FG261000WHT Vented BRUTE® Container)	216
FG9G7700	Rotating Lid with 3-Cup Scoop (fits FG262000WHT Vented BRUTE® Container)	216
FG9G7800	Rotating Lid with 4-Cup Scoop (fits FG263200WHT Vented BRUTE® Container)	216
FG9G8000	Mobile Rack for Shelf Ingredient Bins, 50" wide	215
FG9P9000	Plaza® Jr. Container	66
FG9S0000	Pop-Up Safety Cone, 20" (50.8 cm) with Multilingual "Caution" Imprint and Wet Floor Symbol	146
FG9S0100	Pop-Up Safety Cone, 30" (76.2 cm) with Multilingual "Caution" Imprint and Wet Floor Symbol	146
FG9S1100	Mobile Barrier	147

PART NO.	DESCRIPTION	PAGE
FG9S1500	Site Safety Hanging Sign with "Closed for Cleaning" Imprint – English Only	145
FG9S1600	Site Safety Hanging Sign with Multilingual "Closed for Cleaning" Imprint	145
FG9S3000	BRUTE® Tote with Lid	183
FG9S3100	BRUTE® Tote with Lid	183
FG9T0000	Executive Protective Security Hood for Traditional Housekeeping Carts	131
FG9T1300	Structural Foam Tilt Truck, Utility-Duty	156
FG9T1400	Structural Foam Tilt Truck, Standard-Duty	156
FG9T1500	Structural Foam Tilt Truck, Standard-Duty	156
FG9T1600	Structural Foam Tilt Truck, Heavy-Duty	156
FG9T1900	Executive Full-Size Housekeeping Cart with Doors and Hood – Traditional*	128
FG9T2200	Lid for 1/2-Cubic-Yard Tilt Trucks	156
FG9T2300	Lid for 1-Cubic-Yard Tilt Trucks	156
FG9T6600	Flat Handle Utility Cart (Small) with 5" Casters	165
FG9T6700	Flat Handle Utility Cart (Med) with 5" Casters	165
FG9T6800	Executive Service Cart	168
FG9T7200	Janitorial Cleaning Cart – High-Capacity	135
FG9T7300	Janitorial Cleaning Cart w/Bins – High-Capacity	134
FG9T7400	Janitorial Cleaning Cart Full Swivel w/Bins – High-Capacity	134
FG9T7500	Janitorial Cleaning Cart – High-Security	134
FG9T7800	Executive Housekeeping Compact Cart – High-Security	129
FG9T8200	10-Quart Heavy-Duty Caddy	136
FG9T8301	4-Pack of 5 Qt Disinfecting Pails - Blue, Red, Yellow, Green	136
FG9T8400	30-Quart Organizing Bins – Yellow	136
FG9T8600	Executive Locking Security Hood - High-Capacity	137
FG9T8901	Executive Triple Waste Wire Bag Divider	136
FG9T9000	Executive 9-Pocket Fabric Hanging Organizer	130
FG9T9000	Executive 9-Pocket Fabric Hanging Organizer	136
FG9W0200	Landmark Series® Funnel Top with Panel Frame and FG395800 Rigid Liner	66
FG9W0400	Window Wash Kit for FG9W0200, FG9W0300 Containers	66
FG9W1500LGRAY	Slim Jim® Confidential Document Container with Lid	22
FG9W2100	Standard Rollout Container	17
FG9W2200	Standard Rollout Container	17
FG9W2273	Standard Rollout Container	17
FG9W2500LGRAY	Slim Jim® Confidential Document Container with Lid	22
FG9W2700	Standard Rollout Container	17
FG9W29000000	Security Kit for GroundsKeeper® Tuscan Receptacle	68
FG9W3000	GroundsKeeper® Tuscan Receptacle	68
FG9W3100	Infinity™ Base-Mount Smoking Receptacle	71
FG9W3200	Infinity™ Wall-Mount Smoking Receptacle	71
FG9W3300	Infinity™ Traditional Smoking Receptacle	71
FG9W3400	Infinity™ Ultra-High-Capacity Smoking Receptacle	71
FG9W7200	Mega BRUTE® Mobile Collector Lid	161
FG9W7300	Mega BRUTE® Mobile Collector – 1-Pack	161
FG9W8700	BRUTE® Rim Caddy for 44-Gallon Containers	14
FGA21206	Web Foot® Shrinkless® Wet Mop	101
FGA21306	Web Foot® Shrinkless® Wet Mop	101
FGA25206	Web Foot® Shrinkless® Wet Mop	101
FGA25306	Web Foot® Shrinkless® Wet Mop	101
FGA41206	Web Foot® Finish Mop	101
FGA41306	Web Foot® Finish Mop	101
FGA85206	Web Foot® Microfiber String Mop	100
FGA85306	Web Foot® Microfiber String Mop	100
FGAOT30SAPL	Open Top 113L/30G	54
FGAOT35SA	Open Top 132L/35G	54
FGAOT35SAPL	Open Top 79L/21G	54
FGAOT62SAPL	Open Top 208L/55G	54
FGB25	Black Sand, five 5-lb Bags	69
FGC11306	Swinger Loop® Wet Mop	103
FGC15206	Swinger Loop® Wet Mop	103

PART NO.	DESCRIPTION	PAGE
FGC15306	Swinger Loop® Wet Mop	103
FGD11206	Super Stitch® Cotton Looped-End Wet Mop	104
FGD11306	Super Stitch® Cotton Looped-End Wet Mop	104
FGD15306	Super Stitch® Cotton Looped-End Wet Mop	104
FGD21206	Super Stitch® Blend Mop	104
FGD21306	Super Stitch® Blend Mop	104
FGD25206	Super Stitch® Blend Mop	104
FGD25306	Super Stitch® Blend Mop	104
FGD51306	Super Stitch® Finish Mop	104
FGE05200	18" Microfiber Finish Loop Dust Mop	89
FGE05200	Microfiber Finish Loop Dust Mop 18"	114
FGE13800	Universal Headband Cotton Mop	106
FGE23800	Universal Headband Blue Blend Mop	106
FGE43800	Universal Headband Rayon Mop	106
FGF11600	Premium Cut-End Cotton Mop	107
FGF11700	Premium Cut-End Cotton Mop	107
FGF11800	Premium Cut-End Cotton Mop	107
FGF11900	Premium Cut-End Cotton Mop	107
FGF13700	Synthetic Blend Mop	108
FGF51600	Premium Cut-End Blend Mop	107
FGF51700	Premium Cut-End Blend Mop	107
FGF51800	Premium Cut-End Blend Mop	107
FGH11600	Invader® Side-Gate Wet Mop Handle, Large Yellow Plastic Head, Hardwood Handle	110
FGH12600	Invader® Side-Gate Wet Mop Handle, Large Yellow Plastic Head, Gray Aluminum Handle	110
FGH13600	Invader® Side-Gate Wet Mop Handle, Large Yellow Plastic Head, Vinyl-Covered Aluminum Handle	110
FGH14500	Invader® Side-Gate Wet Mop Handle, Large Yellow Plastic Head, Fiberglass Handle	110
FGH14600	Invader® Side-Gate Wet Mop Handle, Large Yellow Plastic Head, Fiberglass Handle	110
FGH21600	Gripper® Clamp-Style Wet Mop Handle, Plastic Yellow Head, Hardwood Handle	110
FGH22600	Gripper® Clamp-Style Wet Mop Handle, Plastic Yellow Head, Gray Aluminum Handle	110
FGH23600	Gripper® Clamp-Style Wet Mop Handle, Plastic Yellow Head, Vinyl-Coated Aluminum Handle	110
FGH24500	Gripper® Clamp-Style Wet Mop Handle, Plastic Yellow Head, Fiberglass Handle	110
FGH24600	Gripper® Clamp-Style Wet Mop Handle, Plastic Yellow Head, Fiberglass Handle	110
FGH51600	Easy-Change Wet Mop Handle, Large Steel Head, Wood Handle	110
FGJ15300	Trapper® Dust Mop 24"	115
FGJ15700	Trapper® Dust Mop 48"	115
FGJ25300	Twisted-Loop Blend Dust Mop 24"	115
FGJ25500	Twisted-Loop Blend Dust Mop 36"	115
FGJ25700	Twisted-Loop Blend Dust Mop 48"	115
FGJ35300	Twisted-Loop Synthetic Dust Mop 24"	115
FGJ35500	Twisted-Loop Synthetic Dust Mop 36"	115
FGJ85300	Microfiber Loop Dust Mop 24"	114
FGJ85500	Microfiber Loop Dust Mop 36"	114
FGJ85700	Microfiber Loop Dust Mop 48"	114
FGK15300	Kut-A-Way® Dust Mop 24"	115
FGK15500	Kut-A-Way® Dust Mop 36"	115
FGL15300	Blended Cut-End Disposable Dust Mop 24"	116
FGL25300	Cut-End Disposable Cotton Dust Mop 24"	116
FGL25500	Cut-End Disposable Cotton Dust Mop 36"	116
FGM11600	Snap-On Dust Mop Handle, Hardwood	116
FGM14600	Snap-On Dust Mop Handle, Fiberglass	116
FGM15000	Cut-to-Length Dust Mop	117
FGM25300	Snap-On Wire Dust Mop Frame 24"	116
FGM25500	Snap-On Wire Dust Mop Frame 36"	116
FGM25700	Snap-On Wire Dust Mop Frame 48"	116
FGMT32PLBK	Americana Series™ Open Top	67
FGP26900	Low-Profile with Green Scrub Strips Bonnet	117

UTILITY AND RECYCLING REFUSE

DECORATIVE REFUSE

CLEANING

MATERIAL HANDLING

WASHROOM

FOODSERVICE

ACCESSORIES & INDEX



PART NO.	DESCRIPTION	PAGE
FGQ05000	Flat Mop, Includes Bucket with Lid, Sieve, 6 Pads, 1 Frame	89
FGQ18000	17" (43.2 cm) HYGEN™ Hook-and-Loop Replacement Set for FGQ56000	80
FGQ36000	35" (88.9 cm) HYGEN™ Hook-and-Loop Replacement Set for FGQ58000	80
FGQ40800	18" Light Commercial Microfiber Fringed Dust Mop	87
FGQ40900	18" Light Commercial Microfiber Damp Mop	87
FGQ41000	18" (45.7 cm) HYGEN™ Microfiber Damp Room Mop	79
FGQ41100	24" (61.0 cm) HYGEN™ Microfiber Damp Room Mop	79
FGQ41200	18" (45.7 cm) HYGEN™ Microfiber Room Dust Mop	78
FGQ41500	18" (45.7 cm) HYGEN™ Microfiber Damp Mop with Scrubber	79
FGQ41600	18" (45.7 cm) HYGEN™ Microfiber High-Absorbency Mop	79
FGQ41800	18" (45.7 cm) HYGEN™ Microfiber Fringed Dust Mop	78
FGQ42600	24" (61 cm) HYGEN™ Microfiber Fringed Dust Mop	78
FGQ43800	36" (91.4 cm) HYGEN™ Microfiber Fringed Dust Mop	78
FGQ44900	48" (121.9 cm) HYGEN™ Microfiber Fringed Dust Mop	78
FGQ46000	60" (152.4 cm) HYGEN™ Microfiber Fringed Dust Mop	78
FGQ55000	11" (27.9 cm) HYGEN™ Quick-Connect Wet/Dry Frame	80
FGQ55900	Light Commercial 18" (45.7 cm) HYGEN™ Quick-Connect Frame	80
FGQ55900	18" Light Commercial Quick-Connect Wet/Dry Plastic Frame	87
FGQ56000	17" (43.2 cm) (45.7 cm) HYGEN™ Quick-Connect Wet/Dry Frame	80
FGQ57000	24" (61 cm) HYGEN™ Quick-Connect Wet/Dry Frame With Squeegee	80
FGQ58000	35" (88.9 cm) HYGEN™ Quick-Connect Hall Dusting Frame	80
FGQ59000	47" (119.4 cm) HYGEN™ Quick-Connect Hall Dusting Frame	80
FGQ59500	59" (149.9 cm) HYGEN™ Quick-Connect Hall Dusting Frame	80
FGQ60000	59" (149.9 cm) HYGEN™ Hook-and-Loop Replacement Set for FGQ59500	80
FGQ61000	HYGEN™ Microfiber Bathroom Cloth (Yellow)	76
FGQ62000	HYGEN™ Microfiber General-Purpose Cloth (Green, Red, or Blue)	76
FGQ62006	HYGEN™ Microfiber General-Purpose Cloth (Green)	76
FGQ63000	HYGEN™ Microfiber Glass/Mirror Cloth (Blue)	76
FGQ63006	HYGEN™ Microfiber Glass/Mirror Cloth (Blue)	76
FGQ70100	HYGEN™ Quick-Connect Ergo Adjustable Handle	81
FGQ74500	20"-40" (50.8 cm-101.6 cm)	81
FGQ74900	48"-72" (121.9 cm-182.9 cm)	81
FGQ74900	52" Light Commercial Quick-Connect Steel Handle	87
FGQ75000	HYGEN™ Quick-Connect Short Extension Handle	81
FGQ75500	58" (147.3 cm) HYGEN™ Quick-Connect Handle	81
FGQ75500	48"-72" HYGEN™ Quick-Connect Straight Extension Handle	86
FGQ76000	48"-72" (121.9 cm-182.9 cm)	81
FGQ76500	HYGEN™ Quick-Connect Straight Extension Handle	81
FGQ80000	18" (45.7 cm) Flat Mop	89
FGQ80500	Flow™ Nylon Flat Mop	88
FGQ81000	18" (45.7 cm) HYGEN™ Microfiber Super Scrubber Mop	79
FGQ82000	11" (27.9 cm) HYGEN™ Microfiber Wall/Stair Damp Mop	79
FGQ85000	HYGEN™ Quick-Connect Flexible Dusting Wand with Microfiber Sleeve	84
FGQ85100	HYGEN™ Wand Duster Microfiber Replacement Sleeve	84
FGQ85200	Executive 22" HYGEN™ Multipurpose Flexible Microfiber Duster and Frame	84
FGQ85300	Executive 22" HYGEN™ Multipurpose Flexible Microfiber Duster	84
FGQ85500	11" HYGEN™ Microfiber Flexi-Frame	77
FGQ85600	HYGEN™ Microfiber Flexi-Frame Duster Cover	77
FGQ86100	11" HYGEN™ Microfiber Flexi-Frame Hi-Pile Cover	77
FGQ87100	HYGEN™ Microfiber Flexi-Frame Glass Cover	77
FGQ88100	HYGEN™ Microfiber Flexi-Frame Tub and Tile Cover	77
FGQ89100	HYGEN™ Microfiber Flexi-Frame Damp Mop Cover	77
FGQ90088	HYGEN™ Press Wring Bucket	82
FGQ93000	Finish Bucket	89
FGQ95088	HYGEN™ Charging Bucket	82
FGQ96600	HYGEN™ PULSE™ Caddy	83
FGQ97900	Flow™ Flat Mop Finish Kit	88
FGR1	Smokers' Pole	68
FGR1012E	Smokers' Station® Wall-Mount Urn w/ Keyed Cam Lock	70

PART NO.	DESCRIPTION	PAGE
FGR1639E	Aladdin Smokers' Station®	69
FGR2030EPLBK	Eclipse Open Top Metal Refuse	55
FGR2030SSPL	Eclipse Open Top Metal Refuse	55
FGR80DC	Refrigerator/Freezer Thermometer (-20° - 80°F)	224
FGR93400	Metropolitan Smokers' Station	70
FGS22600	Wall Washer Kit Includes 1 Aluminum Handle, 1 Plastic Head, 2 Cotton Pads	124
FGS29900	Wall Washer Replacement Pads, Launderable Cotton	124
FGS3ETBKPL	Open Top 94L/25G	56
FGS55ETBKPL	Open Top 193L/51G	56
FGS55STSSPL	Open Top 193L/51G	56
FGSC14EPLSM	Square Open Top 60L/16G	49
FGSC14EPLTBK	Square Open Top 60L/16G	49
FGSC18EPLSM	Square Open Top 75L/20G	49
FGSC18EPLTBK	Square Open Top 75L/20G	49
FGSC18SSPL	Square Open Top 75L/20G	49
FGSC22EPLSM	Square Open Top 151L/40G	49
FGSC22EPLTBK	Square Open Top 151L/40G	49
FGSH12EPLSM	Open Top Perforated Panels	53
FGSH12EPLTBK	Open Top Perforated Panels	53
FGSH12SSPL	Open Top Perforated Panels	53
FGSO1220PLBK	Open Top Solid Panels	53
FGSO12SSSPL	Open Top Solid Panels	53
FGSO16SSSGL	Flat Top 45L/12G	55
FGSO820PLBK	Flat Top	53
FGSO8SSSPL	Flat Top	53
FGSR18EPLSM	Large Rectangle 85L/22.5G	49
FGSR18EPLTBK	Large Rectangle 85L/22.5G	49
FGSR18SSPL	Large Rectangle 85L/22.5G	49
FGST12EPLRD	Square Step Can 45L/6.5G	52
FGST12EPLWH	Square Step Can 45L/6.5G	52
FGST12SSPL	Square Step Can 45L/6.5G	52
FGST24EPLRD	Square Step Can 90L/13G	52
FGST24EPLWH	Square Step Can 90L/13G	52
FGST24SSPL	Square Step Can 90L/13G	52
FGST40EPLWH	Square Step Can 151L/25G	52
FGST40SSPL	Square Step Can 151L/25G	52
FGST7EPLRD	Square Step Can 26L/4G	52
FGT11000	Overhead Dusting Tool with Launderable Head, 51" l (129.5 cm) Extension Handle	117
FGT12000	Overhead Dusting Tool with Angled Launderable Head, 51" l (129.5 cm) Extension Handle	117
FGT19900	Overhead Dusting Tool Replacement Head fits FGT11000, FGT12000, FGT13000	117
FGT25500	Rough-Floor Wet Mop	109
FGT25600	Rough-Floor Wet Mop	109
FGT30000	Maintenance Mop	109
FGT81206	Web Foot® Microfiber Tube Mop	100
FGT81306	Web Foot® Microfiber Tube Mop	100
FGT85206	Web Foot® Microfiber Tube Mop	100
FGT85306	Web Foot® Microfiber Tube Mop	100
FGTH0550	Oven Thermometer (60° - 580°F)	224
FGTHP220DS	Pocket Thermometer (0° - 220°F), Dishwasher Safe	224
FGV11600	Economy Cotton Cut-End Mop	108
FGV11700	Economy Cotton Cut-End Mop	108
FGV11800	Economy Cotton Cut-End Mop	108
FGV11900	Economy Cotton Cut-End Mop	108
FGV41800	Economy Rayon Cut-End Mop	108
FGV41900	Economy Rayon Cut-End Mop	108
FGWB96R	Steel Wastebasket Open Top	38
FGWMB20	Concept Collection™ Open-Top Wastebasket	34
M1564200	Wheel for FG564200	182

COMPONENT PART	COMPONENT DESCRIPTION	FITS	PAGE # (OF 'FITS' SKU)
1791803	SRP Endcaps with 2 Screws, Black	FGQ55000YL00	80
1791803	SRP Endcaps with 2 Screws, Black	FGQ56000YL00	80
1791803	SRP Endcaps with 2 Screws, Black	FGQ58000YL00	80
1791803	SRP Endcaps with 2 Screws, Black	FGQ59000YL00	80
2146547	Replacement Clips	2131929	13
FG1005L40000	3.5" Casters with Hardware	FG130500BLA	157
FG1005L40000	3.5" Casters with Hardware	FG130573BLUE	157
FG1005L40000	3.5" Casters with Hardware	FG130600BLA	157
FG1011L10000	12" Wheel with Hardware	FG101100BLA	156
FG1011L20000	4" Caster with Hardware	FG101100BLA	156
FG1013L10000	12" Wheel with Hardware	FG101300BLA	156
FG1013L20000	4" Caster with Hardware	FG101300BLA	156
FG1013L20000	4" Caster with Hardware	FG9T1400BLA	156
FG1014L30000	12" Wheel with Hardware	FG131400BLA	157
FG1025L40000	4" Swivel Caster with Hardware	FG102500BLA	157
FG1025L40000	4" Swivel Caster with Hardware	FG103600BLA	157
FG1025L40000	4" Swivel Caster with Hardware	FG104600BLA	157
FG1025L5BLA	Frame Assembly for Tilt Truck, Black	FG102500BLA	157
FG1025L5RED	Frame Assembly for Tilt Truck, Red	FG102500BLA	157
FG1026L60000	12" Wheel with Hardware	FG103600BLA	157
FG1026L60000	12" Wheel with Hardware	FG104600BLA	157
FG1046L5RED	Frame Assembly for Tilt Truck, Red	FG104600BLA	157
FG1054L40000	6" Swivel Caster with Hardware	FG105943BLA	161
FG1304L2RED	Frame Assembly for Tilt Truck, Red	FG130400BLA	157
FG1304L30000	4" Swivel Threaded Caster	FG130400BLA	157
FG1305L2BLA	Frame Assembly for Tilt Truck, Black	FG130500BLA	157
FG1305L2BLA	Frame Assembly for Tilt Truck, Black	FG130600BLA	157
FG1305L2RED	Frame Assembly for Tilt Truck, Red	FG130500BLA	157
FG1305L2RED	Frame Assembly for Tilt Truck, Red	FG130600BLA	157
FG1305L4BLA	1/2 & 1 cu yd Tilt Truck Handle, Black	FG130500BLA	157
FG1305L4BLA	1/2 & 1 cu yd Tilt Truck Handle, Black	FG130573BLUE	157
FG1305L4BLA	1/2 & 1 cu yd Tilt Truck Handle, Black	FG130600BLA	157
FG1305L4BLA	1/2 & 1 cu yd Tilt Truck Handle, Black	FG131400BLA	157
FG1305L4BLA	1/2 & 1 cu yd Tilt Truck Handle, Black	FG131500BLA	157
FG1305L4BLA	1/2 & 1 cu yd Tilt Truck Handle, Black	FG131500RED	157
FG1305L4BLA	1/2 & 1 cu yd Tilt Truck Handle, Black	FG131600BLA	157
FG1305L4RED	1/2 & 1 cu yd Tilt Truck Handle, Red	FG130500BLA	157
FG1305L4RED	1/2 & 1 cu yd Tilt Truck Handle, Red	FG130573BLUE	157
FG1305L4RED	1/2 & 1 cu yd Tilt Truck Handle, Red	FG130600BLA	157
FG1305L4RED	1/2 & 1 cu yd Tilt Truck Handle, Red	FG131400BLA	157
FG1305L4RED	1/2 & 1 cu yd Tilt Truck Handle, Red	FG131500BLA	157
FG1305L4RED	1/2 & 1 cu yd Tilt Truck Handle, Red	FG131500RED	157
FG1305L4RED	1/2 & 1 cu yd Tilt Truck Handle, Red	FG131600BLA	157
FG1314L2BLA	Frame Assembly for Tilt Truck, Black	FG131400BLA	157
FG1314L30000	5" Swivel Threaded Caster	FG131400BLA	157
FG1315L2BLA	Frame Assembly for Tilt Truck, Black	FG131500BLA	157
FG1315L2BLA	Frame Assembly for Tilt Truck, Black	FG131500RED	157
FG1315L2BLA	Frame Assembly for Tilt Truck, Black	FG131600BLA	157
FG1315L2RED	Frame Assembly for Tilt Truck, Red	FG131500BLA	157
FG1315L2RED	Frame Assembly for Tilt Truck, Red	FG131500RED	157
FG1315L2RED	Frame Assembly for Tilt Truck, Red	FG131600BLA	157
FG1315L30000	12" Wheel for 1 cu yd Tilt Truck	FG131500BLA	157
FG1315L30000	12" Wheel for 1 cu yd Tilt Truck	FG131500RED	157
FG1315L30000	12" Wheel for 1 cu yd Tilt Truck	FG9T1500BLA	156
FG1316L4RED	Hitch For Towable Trainable Tile Truck, Red	FG131641BLA	160
FG2523L10000	Step Stool Caster	FG252300BEIG	140
FG2523L10000	Step Stool Caster	FG252300BLA	140
FG2523L3BLA	Step Stool Step Pad, Black	FG252300BEIG	140
FG2531L4BLA	Lobby Pro® Dust Pan Wheels, Black	FG253100BLA	121
FG2532L1BLA	Lobby Pro® Dust Pan Cover, Black	FG253200BLA	121
FG2532L2BLA	Lobby Pro® Handle, Black	FG253200BLA	121
FG256RL2DGRN	Glutton® Square Insert, Dark Green	1792372	37
FG256RL3DGRN	Glutton® Paper Insert, Dark Green	1792372	37
FG256RL4DGRN	Glutton® Circle Insert, Dark Green	1792372	37
FG256RL5DGRN	Glutton® Triangle Insert, Dark Green	1792372	37
FG2570L4BEIG	Replacement GroundsKeeper® Receptacle, Beige	FG257088BEIG	68
FG2570L4BEIG	Replacement GroundsKeeper® Receptacle, Beige	FG257088BLA	68
FG2570L4BEIG	Replacement GroundsKeeper® Receptacle, Beige	FG9W3000BLA	68

COMPONENT PART	COMPONENT DESCRIPTION	FITS	PAGE # (OF 'FITS' SKU)
FG2570L4BEIG	Replacement GroundsKeeper® Receptacle, Beige	FG9W3000SSTON	68
FG2570L4BLA	Replacement GroundsKeeper® Receptacle, Black	FG257088BEIG	68
FG2570L4BLA	Replacement GroundsKeeper® Receptacle, Black	FG257088BLA	68
FG2570L4BLA	Replacement GroundsKeeper® Receptacle, Black	FG9W3000BLA	68
FG2570L4BLA	Replacement GroundsKeeper® Receptacle, Black	FG9W3000SSTON	68
FG2570L4BRN	Replacement GroundsKeeper® Receptacle, Brown	FG257088BEIG	68
FG2570L4BRN	Replacement GroundsKeeper® Receptacle, Brown	FG257088BLA	68
FG2570L4BRN	Replacement GroundsKeeper® Receptacle, Brown	FG9W3000BLA	68
FG2570L4BRN	Replacement GroundsKeeper® Receptacle, Brown	FG9W3000SSTON	68
FG2650L10000	3" Plastic Dolly Caster	FG265000BLA	14
FG342L160000	3" Caster Kit (4)	FG342100BLA	169
FG3424L60000	4" Swivel Caster with Insert	FG342488BLA	169
FG3424L60000	4" Swivel Caster with Insert	FG342488OWHT	169
FG3424L60000	4" Swivel Caster with Insert	FG342488PLAT	169
FG3424L60000	4" Swivel Caster with Insert	FG345700BLA	169
FG3424L60000	4" Swivel Caster with Insert	FG409100BLA	169
FG3424L60000	4" Swivel Caster with Insert	FG409100GRAY	169
FG3424L60000	4" Swivel Caster with Insert	FG409100GRAY	169
FG3424L60000	4" Swivel Caster with Insert	FG409100OWHT	169
FG3424L60000	4" Swivel Caster with Insert	FG409100WHT	169
FG3424L60000	4" Swivel Caster with Insert	FG409300BLA	169
FG3424L60000	4" Swivel Caster with Insert	FG409400GRAY	169
FG3424L60000	4" Swivel Caster with Insert	FG409500BLA	169
FG3424L60000	4" Swivel Caster with Insert	FG9T6800BLA	168
FG3424L60000	4" Swivel Caster with Insert	FG9T7200BLA	135
FG3424L60000	4" Swivel Caster with Insert	FG9T7300BLA	134
FG3424L60000	4" Swivel Caster with Insert	FG9T7400BLA	134
FG3424L60000	4" Swivel Caster with Insert	FG9T7800BLA	129
FG3530L10000	3" Swivel Caster with Stem and Hardware	FG264000BLA	14
FG3530L10000	3" Swivel Caster with Stem and Hardware	FG353000BLA	14
FG3559L30000	Axle for BRUTE® Rollout Containers	1829411	17
FG3559L30000	Axle for BRUTE® Rollout Containers	FG9W2700BLUE	17
FG3559L30000	Axle for BRUTE® Rollout Containers	FG9W2700GRAY	17
FG3559L30000	Axle for BRUTE® Rollout Containers	FG9W2773BLUE	17
FG3964L30000	Plaza® Container Latch Kit	FG396400BEIG	66
FG3964L30000	Plaza® Container Latch Kit	FG396400BLA	66
FG3964L30000	Plaza® Container Latch Kit	FG396500BEIG	66
FG3964L50000	Plaza® Container Hardware Kit	FG396400BEIG	66
FG3964L50000	Plaza® Container Hardware Kit	FG396400BLA	66
FG3964L50000	Plaza® Container Hardware Kit	FG396400DGRN	66
FG3964L50000	Plaza® Container Hardware Kit	FG396500BEIG	66
FG3964L60000	Plaza® Container Lock & Key	FG396400BEIG	66
FG3964L60000	Plaza® Container Lock & Key	FG396400BLA	66
FG3964L60000	Plaza® Container Lock & Key	FG396400DGRN	66
FG3964L60000	Plaza® Container Lock & Key	FG396500BEIG	66
FG3965L10000	Plaza® Container Ash Tray Kit	FG396500BEIG	66
FG3970L40000	Landmark Series® Lock & Keys	FG397000BLA	62
FG3970L40000	Landmark Series® Lock & Keys	FG397500BLA	62
FG3970L40000	Landmark Series® Lock & Keys	FG397500SBLE	62
FG3972L20000	Hardware Kit	FG397000BLA	62
FG3972L20000	Hardware Kit	FG397001SBLE	62
FG3972L20000	Hardware Kit	FG397500BLA	62
FG3972L20000	Hardware Kit	FG397500SBLE	62
FG3972L20000	Hardware Kit	FG397501BLA	62
FG3975L1BLA	Landmark Series® Dome Top Replacement, Black	FG397000BLA	62
FG3975L1BLA	Landmark Series® Dome Top Replacement, Black	FG397500BLA	62
FG3975L1BLA	Landmark Series® Dome Top Replacement, Black	FG397500SBLE	62
FG3975L1DWOOD	Landmark Series® Dome Top Replacement, Driftwood	FG397000BLA	62



UTILITY AND
RECYCLING REFUSE

DECORATIVE REFUSE

CLEANING

MATERIAL HANDLING

WASHROOM

FOODSERVICE

ACCESSORIES
& INDEX

COMPONENT PART	COMPONENT DESCRIPTION	FITS	PAGE # (OF 'FITS' SKU)
FG3975L1DWOOD	Landmark Series® Dome Top Replacement, Driftwood	FG397500BLA	62
FG3975L1DWOOD	Landmark Series® Dome Top Replacement, Driftwood	FG397500SBLA	62
FG3975L1SBLA	Landmark Series® Dome Top Replacement, Sable	FG397000BLA	62
FG3975L1SBLA	Landmark Series® Dome Top Replacement, Sable	FG397500BLA	62
FG3975L1SBLA	Landmark Series® Dome Top Replacement, Sable	FG397500SBLA	62
FG3975L3DWOOD	Landmark Series® Stationary/Moving Collar, Driftwood	FG397000BLA	62
FG3975L3DWOOD	Landmark Series® Stationary/Moving Collar, Driftwood	FG397500BLA	62
FG3975L3DWOOD	Landmark Series® Stationary/Moving Collar, Driftwood	FG397500SBLA	62
FG3975L3SBLA	Landmark Series® Stationary/Moving Collar, Sable	FG397000BLA	62
FG3975L3SBLA	Landmark Series® Stationary/Moving Collar, Sable	FG397500BLA	62
FG3975L3SBLA	Landmark Series® Stationary/Moving Collar, Sable	FG397500SBLA	62
FG3975L6DWOOD	Landmark Series® Deco Leg	FG397500BLA	62
FG4094L1BLA	Door Kit with Lock for Xtra™ Cart, Black	FG409400GRAY	169
FG4094L1BLA	Door Kit with Lock for Xtra™ Cart, Black	FG409500BLA	169
FG4094L1LGRAY	Door Kit with Lock for Xtra™ Cart, Gray	FG409400GRAY	169
FG4094L1LGRAY	Door Kit with Lock for Xtra™ Cart, Gray	FG409500BLA	169
FG4402L10000	5" Rubber Swivel Caster	FG131500BLA	157
FG4402L10000	5" Rubber Swivel Caster	FG131500RED	157
FG4402L10000	5" Rubber Swivel Caster	FG440300BLA	171
FG4402L40000	8" Pneumatic Rigid Caster	FG443610BLA	171
FG4403L10000	Hardware Kit	FG440300	171
FG4403L10000	Hardware Kit	FG440600	171
FG4403L10000	Hardware Kit	FG443600	171
FG4403L10000	Hardware Kit	FG443610	171
FG4403L10000	Hardware Kit	FG444100	171
FG4403L10000	Hardware Kit	FG446600	171
FG4403L10000	Hardware Kit	FG446800	174
FG4403L10000	Hardware Kit	FG447100	171
FG4403L10000	Hardware Kit	FG448600	171
FG4406L60000	6" Poly Swivel and Fixed Caster Replacement Kit	FG440600BLA	171
FG4436L80000	8" TPR Swivel and Fixed Caster Replacement Kit	FG443600BLA	171
FG4436L80000	8" TPR Swivel and Fixed Caster Replacement Kit	FG446600BLA	171
FG4436L80000	8" TPR Swivel and Fixed Caster Replacement Kit	FG448600BLA	171
FG4436M10000	8" Pneumatic Swivel & Fixed Caster Replacement Kit	FG443610BLA	171
FG4441L10000	8" Poly Swivel and Fixed Caster Replacement Kit	FG444100BLA	171
FG4441L10000	8" Poly Swivel and Fixed Caster Replacement Kit	FG446800BLA	174
FG4441L10000	8" Poly Swivel and Fixed Caster Replacement Kit	FG447100BLA	171
FG4500L50000	Hardware Kit	FG452010BEIG	165
FG4500L50000	Hardware Kit	FG452010BLA	165
FG4500M20000	Hardware Kit	FG450088BEIG	165
FG4500M20000	Hardware Kit	FG450088BLA	165
FG4500M20000	Hardware Kit	FG452010BEIG	165
FG4500M20000	Hardware Kit	FG452010BLA	165
FG4500M20000	Hardware Kit	FG452088BEIG	165
FG4500M20000	Hardware Kit	FG452088BLA	165
FG4500M20000	Hardware Kit	FG452500BEIG	165
FG4500M20000	Hardware Kit	FG452500BLA	165
FG4500M20000	Hardware Kit	FG454600BLA	165
FG4500M20000	Hardware Kit	FG454610BEIG	165
FG4500M20000	Hardware Kit	FG454610BLA	165
FG4501L10000	5" Rigid Caster	FG430000BLA	167
FG4501L10000	5" Rigid Caster	FG440100BLA	171

COMPONENT PART	COMPONENT DESCRIPTION	FITS	PAGE # (OF 'FITS' SKU)
FG4501L10000	5" Rigid Caster	FG450088BEIG	165
FG4501L10000	5" Rigid Caster	FG450088BLA	165
FG4501L10000	5" Rigid Caster	FG450500BLA	165
FG4501L10000	5" Rigid Caster	FG452500BLA	165
FG4501L10000	5" Rigid Caster	FG618000BLA	166
FG4501L20000	5" Swivel Caster	FG440100BLA	170
FG4501L20000	5" Swivel Caster	FG450088BEIG	165
FG4501L20000	5" Swivel Caster	FG450088BLA	165
FG4501L20000	5" Swivel Caster	FG450500BLA	165
FG4501L20000	5" Swivel Caster	FG452088BEIG	165
FG4501L20000	5" Swivel Caster	FG452088BLA	165
FG4501L20000	5" Swivel Caster	FG452500BLA	165
FG4505L30000	Caster Kit for Flat Shelf Carts	FG450089BLA	165
FG4505L30000	Caster Kit for Flat Shelf Carts	FG450500BLA	165
FG4505L30000	Caster Kit for Flat Shelf Carts	FG450589BLA	165
FG4505L30000	Caster Kit for Flat Shelf Carts	FG452089BEIG	165
FG4505L30000	Caster Kit for Flat Shelf Carts	FG452089BLA	165
FG4505L30000	Caster Kit for Flat Shelf Carts	FG452500BLA	165
FG4505L30000	Caster Kit for Flat Shelf Carts	FG452589BLA	165
FG4510L30000	Hardware Kit	FG450088BEIG	165
FG4510L30000	Hardware Kit	FG450088BLA	165
FG4510L30000	Hardware Kit	FG452088BEIG	165
FG4510L30000	Hardware Kit	FG452088BLA	165
FG4510L30000	Hardware Kit	FG454600BLA	165
FG4512LSRED	Single Drawer Hardware Kit	FG453388BLA	167
FG4512L60000	Door Hardware Kit (Lock) For TradeMaster	FG453388BLA	167
FG4512L70000	Back Panel Bracket	FG451388BLA	167
FG4512L70000	Back Panel Bracket	FG453388BLA	167
FG4513L20000	4-Drawer Hardware Kit	FG453388BLA	167
FG4532L20000	5" Swivel Caster with Lock (Heavy Duty)	FG451388BLA	167
FG4532L20000	5" Swivel Caster with Lock (Heavy Duty)	FG453388BLA	167
FG4532L70000	Caster Installation Kit	FG451388BLA	167
FG4532L70000	Caster Installation Kit	FG453388BLA	167
FG4546L10000	5" Swivel Caster	FG454600BLK	165
FG4614L30000	5" Swivel Caster with Hardware	FG461400BLA	160
FG4614L30000	5" Swivel Caster with Hardware	FG461600BLA	160
FG4614L30000	5" Swivel Caster with Hardware	FG461900BLA	160
FG4614L30000	5" Swivel Caster with Hardware	FG471600BLA	160
FG4614L30000	5" Swivel Caster with Hardware	FG472000BLA	160
FG4614L40000	5" Rigid Caster	FG461100BLA	160
FG4614L40000	5" Rigid Caster	FG461400BLA	160
FG4614L40000	5" Rigid Caster	FG461900BLA	160
FG4614L40000	5" Rigid Caster	FG471600BLA	160
FG4614L40000	5" Rigid Caster	FG472000BLA	160
FG4708L30000	4" Swivel Caster	FG470800BLA	160
FG4708L30000	4" Swivel Caster	FG471200BLA	160
FG4708L40000	4" Rigid Caster	FG470800BLA	160
FG4708L40000	4" Rigid Caster	FG471200BLA	160
FG4727L10000	5" Swivel Caster	FG472700BLA	160
FG4727L20000	6" Rigid Caster		
FG4727L30000	6" Swivel Caster	FG131641BLA	160
FG6170L10000	Polyliner Holder	FG817088BEIG	56
FG6170L10000	Polyliner Holder	FG817088BLA	56
FG6170L10000	Polyliner Holder	FG817088BRN	56
FG6173L10000	4" Caster with Stem	FG617388BLA	135
FG6173L10000	4" Caster with Stem	FG617388BLU	135
FG6173L90000	Wheels and Axle	FG264600BLA	14
FG6173L90000	Wheels and Axle	FG617388BLA	135
FG6173L90000	Wheels and Axle	FG617388BLU	135
FG6173M0BLA	Back Upright Janitor Cart Trolley	FG617388BLA	135
FG6173M0BLA	Back Upright Janitor Cart Trolley	FG617388BLU	135
FG6173M10000	Polyliner Holder	FG618900BLA	128
FG6173M10000	Polyliner Holder	FG619000BLA	128
FG6173M10000	Polyliner Holder	FG619100BLA	128
FG6173M10000	Polyliner Holder	FG619200BLA	128
FG6173M10000	Polyliner Holder	FG917300BLA	128
FG6173M10000	Polyliner Holder	FG917300BLA	134

COMPONENT PART	COMPONENT DESCRIPTION	FITS	PAGE # (OF 'FITS' SKU)
FG6173M10000	Polyliner Holder	FG9T7400BLA	134
FG6173M10000	Polyliner Holder	FG9T7500BLA	134
FG6173M10000	Polyliner Holder	FG9T7800BLA	129
FG6173M4BLUE	Bottom Shelf for Janitorial Cleaning Cart	FG617388BLA	135
FG6173M4BLUE	Bottom Shelf for Janitorial Cleaning Cart	FG617388BLUE	135
FG6173M6BLA	Left Side Upright for Janitorial Cleaning Cart	FG617388BLA	135
FG6173M6BLA	Left Side Upright for Janitorial Cleaning Cart	FG617388BLUE	135
FG6173M7BLA	Right Side Upright for Janitorial Cleaning Cart	FG617388BLA	135
FG6173M7BLA	Right Side Upright for Janitorial Cleaning Cart	FG617388BLUE	135
FG6173M7BLUE	Right Side Upright for Janitorial Cleaning Cart	FG617388BLA	135
FG6173M7BLUE	Right Side Upright for Janitorial Cleaning Cart	FG617388BLUE	135
FG6173M8BLA	Top Shelf for Janitorial Cleaning Cart	FG617388BLA	135
FG6173M8BLA	Top Shelf for Janitorial Cleaning Cart	FG617388BLUE	135
FG6173M9BLA	Middle Shelf for Janitorial Cleaning Cart	FG617388BLA	135
FG6173M9BLA	Middle Shelf for Janitorial Cleaning Cart	FG617388BLUE	135
FG6181L20000	Lock and Key Replacement for Janitorial Cart	FG618100YEL	135
FG6185M2YEL	44 Qt WaveBrake® Bucket	FG757688YEL	93
FG6185M3BLA	44 Qt WaveBrake® Bucket Bail	FG618688YEL	93
FG6185M3BLA	44 Qt WaveBrake® Bucket Bail	FG757688YEL	93
FG6189L10000	Hardware Kit For Housekeeping Cart	FG618900BLA	128
FG6189L10000	Hardware Kit For Housekeeping Cart	FG619000BLA	128
FG6189L10000	Hardware Kit For Housekeeping Cart	FG619100BLA	128
FG6189L10000	Hardware Kit For Housekeeping Cart	FG619200BLA	128
FG6189L2BLA	Back Panel Kit (2 Panels)	FG619000BLA	128
FG6189L2BLA	Back Panel Kit (2 Panels)	FG619100BLA	128
FG6189L2BLA	Back Panel Kit (2 Panels)	FG619200BLA	128
FG6189L30000	Vacuum Cleaner Holder Kit	FG618900BLA	128
FG6189L30000	Vacuum Cleaner Holder Kit	FG619000BLA	128
FG6189L30000	Vacuum Cleaner Holder Kit	FG619100BLA	128
FG6189L30000	Vacuum Cleaner Holder Kit	FG619200BLA	128
FG6191L10000	Lock with Key Set	FG619100BLA	128
FG6191L10000	Lock with Key Set	FG619200BLA	128
FG6191L10000	Lock with Key Set	FG619700BLA	128
FG6191L10000	Lock with Key Set	FG9T1900BLA	128
FG7570L20000	3" Plastic Caster with Metal Axle	FG748000YEL	93
FG7570L20000	3" Plastic Caster with Metal Axle	FG757688YEL	93
FG7570L20000	3" Plastic Caster with Metal Axle	FG757788BRN	93
FG7570L20000	3" Plastic Caster with Metal Axle	FG757788YEL	93
FG7570L20000	3" Plastic Caster with Metal Axle	FG758888BLUE	93
FG7570L20000	3" Plastic Caster with Metal Axle	FG758888GRN	93
FG7570L20000	3" Plastic Caster with Metal Axle	FG758888RED	93
FG7570L20000	3" Plastic Caster with Metal Axle	FG759088YEL	94
FG7570L20000	3" Plastic Caster with Metal Axle	FGQ93000BLUE	89
FG7575L8BLA	WaveBrake® Gear and Rack Replacement	FG757688YEL	93
FG7575L8BLA	WaveBrake® Gear and Rack Replacement	FG757788BRN	93
FG7575L8BLA	WaveBrake® Gear and Rack Replacement	FG757788YEL	93
FG7575L8BLA	WaveBrake® Gear and Rack Replacement	FG757888BLUE	93
FG7575L8BLA	WaveBrake® Gear and Rack Replacement	FG757888RED	93
FG7806L8BLA	3 Point Strap For High Chair	FG780508BLA	228
FG7806L8BLA	3 Point Strap For High Chair	FG780608BLA	228
FG7806L8BLA	3 Point Strap For High Chair	FG780608PLAT	228
FG7806L8BLA	3 Point Strap For High Chair	FG781408BLA	228
FG7806L8BLA	3 Point Strap For High Chair	FG781408PLAT	228
FG7818L20000	Safety Strap Kit	FG781888PLAT	210
FG7818L40000	Baby Changing Station Horizontal Belt Kit	FG781888PLAT	210
FG7931L30000	6" Rigid Casters (2)	FG440300BLA	171
FG8170L1BEIG	Replaceable Marshal Top with Hardware, Beige	FG817088BEIG	56

COMPONENT PART	COMPONENT DESCRIPTION	FITS	PAGE # (OF 'FITS' SKU)
FG8170L1BEIG	Replaceable Marshal Top with Hardware, Beige	FG817088BLA	56
FG8170L1BEIG	Replaceable Marshal Top with Hardware, Beige	FG817088BRN	56
FG9171L4BLA	Base Ring	FG917188BEIG	65
FG9171L4BLA	Base Ring	FG917388BEIG	65
FG9171L4BLA	Base Ring	FG917388BLA	65
FG9S11L2YEL	Middle Panel (2)	FG9S1100YEL	147
FG9T06L10000	16" Pneumatic Tire	FG131641BLA	160
FG9T13L30000	10" Wheel	FG9T1300BLA	156
FG9T14L10000	10" Wheel	FG9T1400BLA	156
FG9T15L10000	5" Swivel Caster	FG9T1500BLA	156
FG9T15L10000	5" Swivel Caster	FG9T1600BLA	156
FG9T66L10000	5" Caster Kit	FG9T6600BLA	165
FG9T66L10000	5" Caster Kit	FG9T6700BLA	165
FG9T73L4BLA	Bottom Base	FG9T7200BLA	135
FG9T73L4BLA	Bottom Base	FG9T7300BLA	134
FG9T73L4BLA	Bottom Base	FG9T7400BLA	134
FG9T73L4BLA	Bottom Base	FG9T7500BLA	134
FG9T73L4BLA	Bottom Base	FG9T7800BLA	129
FG9T73L5BLA	Handle	FG9T7200BLA	135
FG9T73L5BLA	Handle	FG9T7300BLA	134
FG9T73L5BLA	Handle	FG9T7400BLA	134
FG9T73L5BLA	Handle	FG9T7500BLA	134
FG9T73L5BLA	Handle	FG9T7800BLA	129
FG9T73L60000	Aluminum Uprights Kit	FG9T7200BLA	135
FG9T73L60000	Aluminum Uprights Kit	FG9T7300BLA	134
FG9T73L60000	Aluminum Uprights Kit	FG9T7400BLA	134
FG9T73L60000	Aluminum Uprights Kit	FG9T7500BLA	134
FG9T73L60000	Aluminum Uprights Kit	FG9T7800BLA	129
FG9T73L8BLA	Folding Bag/Bucket Platform	FG9T7300BLA	134
FG9T73L8BLA	Folding Bag/Bucket Platform	FG9T7400BLA	134
FG9T73L8BLA	Folding Bag/Bucket Platform	FG9T7500BLA	134
FG9T73L8BLA	Folding Bag/Bucket Platform	FG9T7800BLA	129
FG9T73L9GRAY	Wheel & Axle Parts	FG9T7200BLA	135
FG9T73L9GRAY	Wheel & Axle Parts	FG9T7300BLA	134
FG9T73L9GRAY	Wheel & Axle Parts	FG9T7800BLA	129
FG9T73M20000	Lock And Key	FG9T7500BLA	134
FG9T73M20000	Lock And Key	FG9T7800BLA	129
FG9T73M4BLA	Tool Grip Rack and Caps	FG9T7200BLA	135
FG9T73M4BLA	Tool Grip Rack and Caps	FG9T7300BLA	134
FG9T73M4BLA	Tool Grip Rack and Caps	FG9T7400BLA	134
FG9T73M4BLA	Tool Grip Rack and Caps	FG9T7500BLA	134
FG9T73M4BLA	Tool Grip Rack and Caps	FG9T7800BLA	129
FG9T73M5BLA	Rubber Tool Grip	FG9T7200BLA	135
FG9T73M5BLA	Rubber Tool Grip	FG9T7300BLA	134
FG9T73M5BLA	Rubber Tool Grip	FG9T7400BLA	134
FG9T73M5BLA	Rubber Tool Grip	FG9T7500BLA	134
FG9T73M5BLA	Rubber Tool Grip	FG9T7800BLA	129
FG9T73M6BLA	Handle Tool Grip Cap	FG9T7200BLA	135
FG9T73M6BLA	Handle Tool Grip Cap	FG9T7300BLA	134
FG9T73M6BLA	Handle Tool Grip Cap	FG9T7400BLA	134
FG9T73M6BLA	Handle Tool Grip Cap	FG9T7500BLA	134
FG9T73M6BLA	Handle Tool Grip Cap	FG9T7800BLA	129
FG9W04L3BLA	Squeegee for Window Wash	FG9W0400BLA	63
FG9W21L10000	Wheel Set (2)	FG9W2100GRAY	17
FG9W21L2BLA	Replacement Rollout Axle Carriage	FG9W2100GRAY	17
FG9W21L2BLA	Replacement Rollout Axle Carriage	FG9W2200GRAY	17
FG9W27L10000	Replacement Wheels/Push Caps (2)	FG9W2700BLUE	17
FG9W27L10000	Replacement Wheels/Push Caps (2)	FG9W2700GRAY	17
FG9W27L10000	Replacement Wheels/Push Caps (2)	FG9W2700YEL	17
FG9W27L10000	Replacement Wheels/Push Caps (2)	FG9W2773BLUE	17
FG9W27L2BLA	Replacement Lid/Handle	FG9W2700BLUE	17
FG9W27L2BLA	Replacement Lid/Handle	FG9W2700GRAY	17
FG9W27L2BLA	Replacement Lid/Handle	FG9W2700YEL	17
FG9W27L2BLA	Replacement Lid/Handle	FG9W2773BLUE	17
FG9W31L1BLA	Funnel Top Domed Cap	FG9W3200SSBLA	71
FG9W31L1BLA	Funnel Top Domed Cap	FG9W3300BLA	71
FG9W34L1AGBRNZ	Domed Cap	FG9W3400BLA	71
FG9W87L1YEL	BRUTE® Rim Caddy Bag Strap, Yellow	FG9W8700YEL	14
FGQ966L10000	PULSE™ Caddy Connect	FGQ966000000	83
FGQ969L10000	PULSE™ Red Cap	FGQ966000000	83

UTILITY AND RECYCLING REFUSE

DECORATIVE REFUSE

CLEANING

MATERIAL HANDLING

WASHROOM

FOODSERVICE

ACCESSORIES & INDEX





© 2024 Rubbermaid Commercial Products LLC
8900 Northpointe Executive Drive, Huntersville, NC 28078
Visit [rubbermaidcommercial.com](https://www.rubbermaidcommercial.com) for more information.

REV 01/24